

WINSTAR Display

OLED SPECIFICATION

Model No:

WEO012864AWPP3A00000

SPECIFICATION

Version: D

CUSTOMER :

MODULE NO. : WEO012864AWPP3A00000

APPROVED BY:
(FOR CUSTOMER USE ONLY)

| SALES BY | APPROVED BY | CHECKED BY | PREPARED BY |
|---------------|-------------|------------|-------------|
| | | | |
| RELEASE DATE: | | | |

APPROVAL FOR SPECIFICATIONS ONLY

APPROVAL FOR SPECIFICATIONS AND SAMPLE

MODEL NO :

| RECORDS OF REVISION | | | DOC. FIRST ISSUE |
|---------------------|------------|------------------|---|
| VERSION | DATE | REVISED PAGE NO. | SUMMARY |
| 0 | 2021/07/27 | | First release |
| A | 2022/10/04 | | Modify Reliability Test and measurement conditions |
| B | 2023/04/27 | | Modify Lifetime note |
| C | 2023/05/18 | | Modify the inspection criteria name of the inspection specification |
| D | 2023/09/01 | | Module classification code 10 modify CTP Laminate bonding description |

Contents

- 1.Module Classification Information
- 2.General Specification
- 3.Contour Drawing & Block Diagram
- 4.Interface Pin Function
- 5.Absolute Maximum Ratings
- 6.Electrical Characteristics
- 7.Optical Characteristics
- 8.OLED Lifetime
- 9.Reliability
- 10.Inspection specification
- 11.Precautions in use of OLED Modules

1. Module Classification Information

W E O 012864 A W P P 3 A 0 0 0 00
 ① ② ③ ④ ⑤ ⑥ ⑦ ⑧ ⑨ ⑩ ⑪ ⑫ ⑬ ⑭

| | | | | |
|----|-------------------------------------|---|--------------------|----------------|
| 1 | Brand : WINSTAR DISPLAY CORPORATION | | | |
| 2 | E : OLED | | | |
| 3 | Display Type | H : COB Character | G : COB Graphic | |
| | | O : COG | F : COG + FR | |
| | | P : COG + FR + PCB | X : COF | |
| | | A : COG + PCB | N : COF + FR + PCB | |
| 4 | Dot Matrix : 128 * 64 | | | |
| 5 | Serials code | | | |
| 6 | Emitting Color | A : Amber | R : Red | C : Full Color |
| | | B : Blue | W : White | |
| | | G : Green | L : Yellow | |
| | | S : Sky Blue | X : Dual Color | |
| 7 | Polarizer | P : With Polarizer; N: Without Polarizer A : Anti-glare Polarizer | | |
| 8 | Display Mode | P : Passive Matrix ; N : Active Matrix | | |
| 9 | Driver Voltage | 3 : 3.0~3.3V ; 5 : 5.0V | | |
| 10 | Touch Panel | N : Without touch panel ; T : Resistive TP; D : CTP (Air bonding) A : CTP (Direct bonding) | | |
| 11 | Product type | 0 : Standard | | |
| 12 | Inspection Grade | 0 : Standard | | |
| 13 | Option | 0 : Default | | |
| 14 | Serial No. | Serial number(00~99) | | |

2.General Specification

| Item | Dimension | Unit |
|------------------|--------------------------|------|
| Dot Matrix | 128 x 64 | — |
| Module dimension | 43.04 x 28.22 x 3.01 | mm |
| Active Area | 35.05 x 17.51 | mm |
| Pixel Size | 0.249 x 0.249 | mm |
| Pixel Pitch | 0.274 x 0.274 | mm |
| Display Mode | Passive Matrix | |
| Display Color | Monochrome (White) | |
| Drive Duty | 1/64 Duty | |
| IC | SSD1309 | |
| Interface | 6800,8080,4-wire SPI,I2C | |
| Size | 1.54 inch | |

| | |
|---------------|--------------|
| CTP IC | FT6336U |
| Detect Point | 1 |
| CTP Interface | I2C |
| Surface | Normal Glare |

3. Contour Drawing & Block Diagram

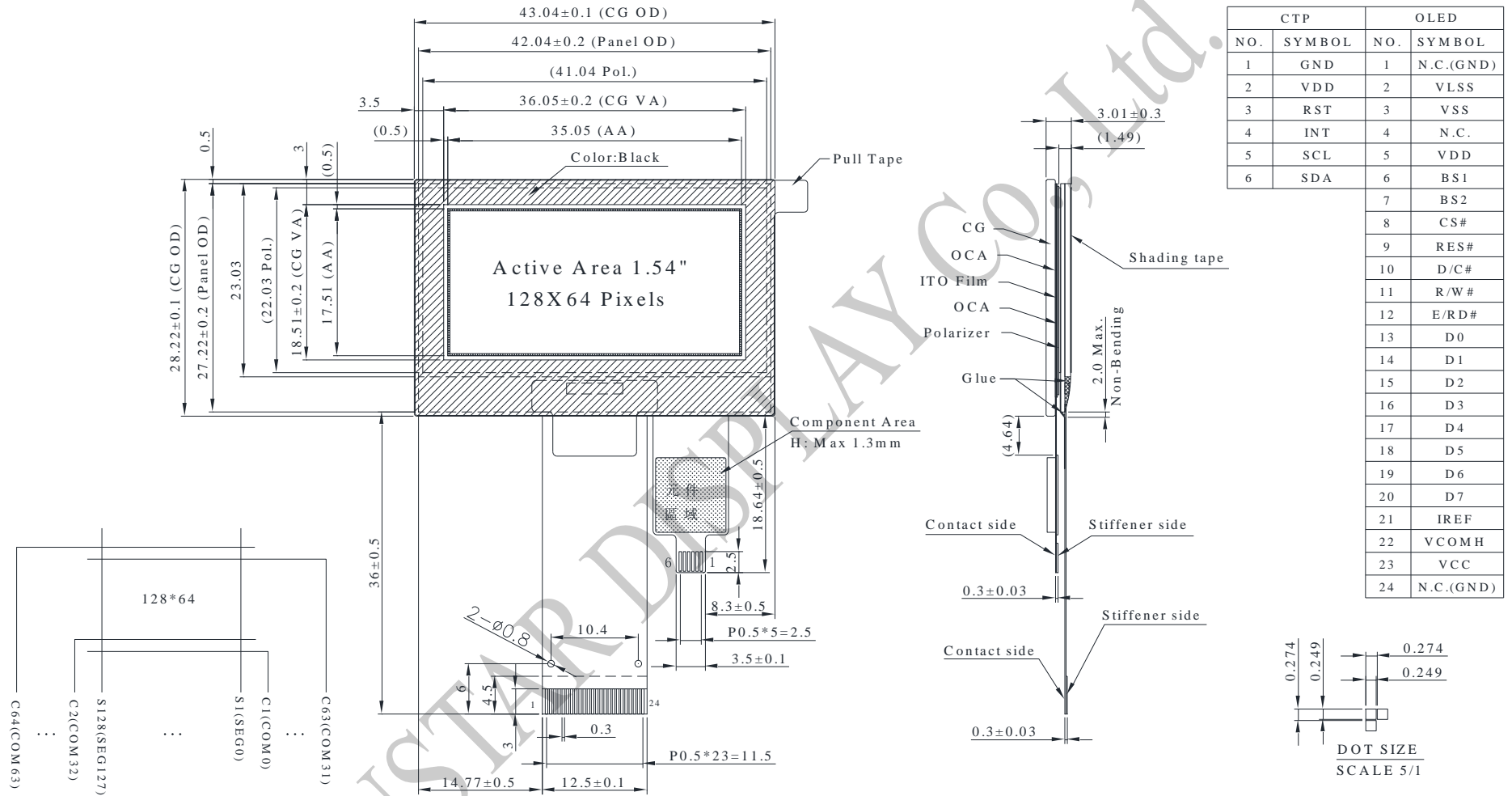

The non-specified tolerance of dimension is ± 0.3 mm.

3.1 Application recommendations

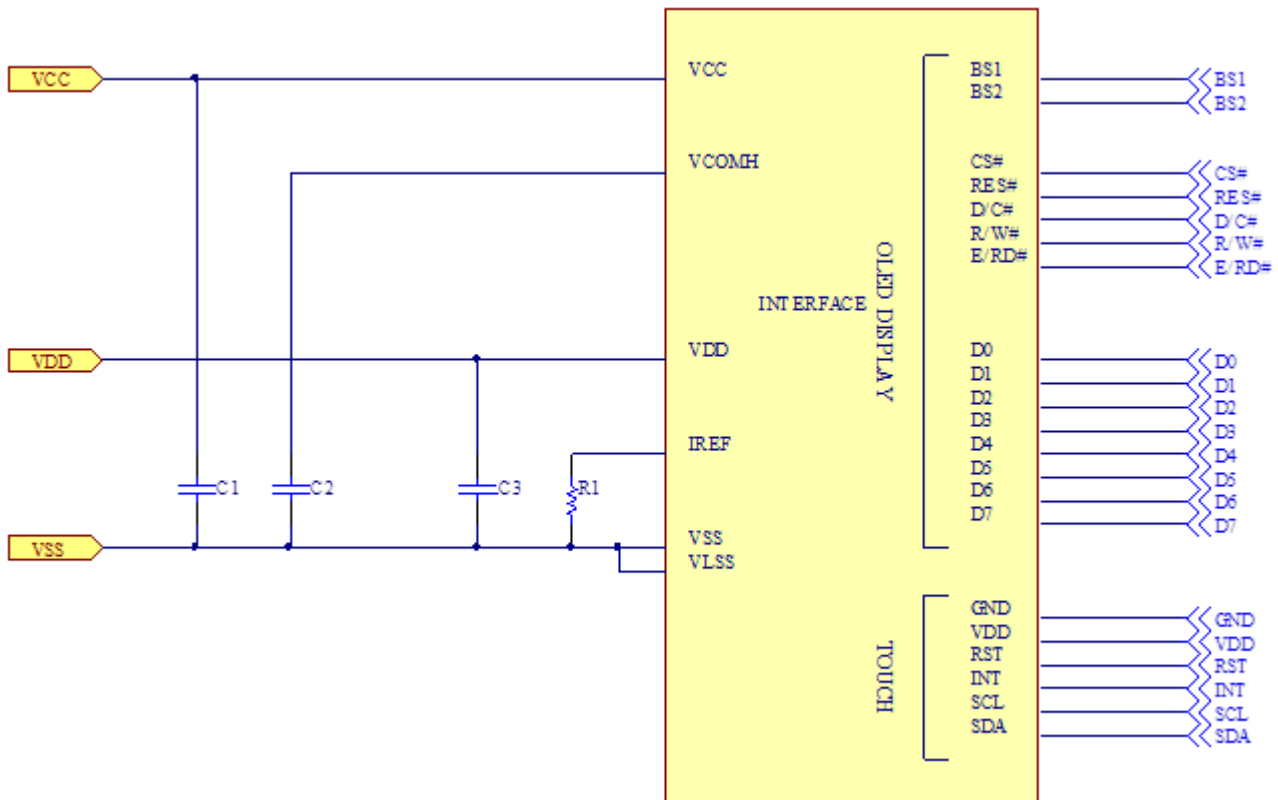

Recommended components:

C1, C2 : 2.2uF/25V/0603

C3 : 1.0uF/16V/0603

Bus Interface selection: (Must be set the BS[2:1], refer to chapter 4)

8-bits 6800 and 8080 parallel, 4-wire SPI, I2C

Voltage at IREF \approx VCC - 3V. For VCC = 12.5V, IREF = 10uA:

$R1 = (\text{Voltage at IREF} - VSS) / IREF$

$= (12.5 - 3)V / 10\mu A$

$\geq 950K\Omega^{(2)}$

Note:

(1).The capacitor value is recommended value. Select appropriate value against module application.

(2). Minimum value. When OLED product application, then R1 must be greater than the calculated value.

4.Interface Pin Function

| No. | Symbol | Function | | | | | | | | | | | | | | | |
|---------------------|---------|---|--|-----|-----|-----|---|---|---------------|---|---|---------------------|---|---|---------------------|---|---|
| 1 | NC(GND) | No connection | | | | | | | | | | | | | | | |
| 2 | VLSS | This is an analog ground pin | | | | | | | | | | | | | | | |
| 3 | VSS | Ground. | | | | | | | | | | | | | | | |
| 4 | NC | No connection | | | | | | | | | | | | | | | |
| 5 | VDD | Power supply pin for core logic operation | | | | | | | | | | | | | | | |
| 6 | BS1 | MCU bus interface selection pins. Select appropriate logic setting as described in the following table. BS2 and BS1 are pin select <table border="1" data-bbox="451 674 1008 894"> <thead> <tr> <th></th> <th>BS1</th> <th>BS2</th> </tr> </thead> <tbody> <tr> <td>I2C</td> <td>1</td> <td>0</td> </tr> <tr> <td>4-wire Serial</td> <td>0</td> <td>0</td> </tr> <tr> <td>8-bit 68XX Parallel</td> <td>0</td> <td>1</td> </tr> <tr> <td>8-bit 80XX Parallel</td> <td>1</td> <td>1</td> </tr> </tbody> </table> | | BS1 | BS2 | I2C | 1 | 0 | 4-wire Serial | 0 | 0 | 8-bit 68XX Parallel | 0 | 1 | 8-bit 80XX Parallel | 1 | 1 |
| | BS1 | BS2 | | | | | | | | | | | | | | | |
| I2C | 1 | 0 | | | | | | | | | | | | | | | |
| 4-wire Serial | 0 | 0 | | | | | | | | | | | | | | | |
| 8-bit 68XX Parallel | 0 | 1 | | | | | | | | | | | | | | | |
| 8-bit 80XX Parallel | 1 | 1 | | | | | | | | | | | | | | | |
| 7 | BS2 | Note (1) 0 is connected to VSS (2) 1 is connected to VDD | | | | | | | | | | | | | | | |
| 8 | CS# | This pin is the chip select input connecting to the MCU. The chip is enabled for MCU communication only when CS# is pulled LOW (active LOW). | | | | | | | | | | | | | | | |
| 9 | RES# | This pin is reset signal input. When the pin is pulled LOW, initialization of the chip is executed. Keep this pin pull HIGH during normal operation. | | | | | | | | | | | | | | | |
| 10 | D/C# | This pin is Data/Command control pin connecting to the MCU. When the pin is pulled HIGH, the data at D[7:0] will be interpreted as data. When the pin is pulled LOW, the data at D[7:0] will be transferred to a command register. In I2C mode, this pin acts as SA0 for slave address selection. | | | | | | | | | | | | | | | |
| 11 | R/W# | This pin is read / write control input pin connecting to the MCU interface. When 6800 interface mode is selected, this pin will be used as Read/Write (R/W#) selection input. Read mode will be carried out when this pin is pulled HIGH and write mode when LOW. When 8080 interface mode is selected, this pin will be the Write (WR#) input. Data write operation is initiated when this pin is pulled LOW and the chip is selected. When serial or I2C interface is selected, this pin must be connected to VSS. | | | | | | | | | | | | | | | |

| | | |
|-------|---------|--|
| 12 | E/RD# | <p>This pin is MCU interface input.</p> <p>When 6800 interface mode is selected, this pin will be used as the Enable (E) signal.</p> <p>Read/write operation is initiated when this pin is pulled HIGH and the chip is selected.</p> <p>When 8080 interface mode is selected, this pin receives the Read (RD#) signal. Read operation is initiated when this pin is pulled LOW and the chip is selected.</p> <p>When serial or I2C interface is selected, this pin must be connected to VSS.</p> |
| 13-20 | D0~D7 | <p>These pins are bi-directional data bus connecting to the MCU data bus. Unused pins are recommended to tie LOW.</p> <p>When serial interface mode is selected, D0 will be the serial clock input: SCLK; D1 will be the serial data input: SDIN and D2 should be kept NC.</p> <p>When I2C mode is selected, D2, D1 should be tied together and serve as SDAout, SDAin in application and D0 is the serial clock input, SCL.</p> |
| 21 | IREF | <p>This pin is the segment output current reference pin.</p> <p>IREF is supplied externally.</p> |
| 22 | VCOMH | <p>COM signal deselected voltage level.</p> <p>A capacitor should be connected between this pin and VSS.</p> |
| 23 | VCC | <p>Power supply for panel driving voltage. This is also the most positive power voltage supply pin.</p> |
| 24 | NC(GND) | No connection |

CTP Pin Function

| | | |
|---|------------|--------------------------------|
| 1 | GND | Ground. |
| 2 | VDD | Power Supply Voltage of CTP |
| 3 | RST | External Reset, Low is active |
| 4 | INT | External interrupt to the host |
| 5 | SCL | I2C clock input |
| 6 | SDA | I2C data input and output |

5. Absolute Maximum Ratings

5.1 Absolute Maximum Ratings

| Parameter | Symbol | Min | Max | Unit | Notes |
|----------------------------|--------|------|-----|------|-------|
| Supply Voltage for Logic | VDD | -0.3 | 4 | V | 1, 2 |
| Supply Voltage for Display | VCC | 0 | 17 | V | 1, 2 |
| Operating Temperature | TOP | -10 | +60 | °C | — |
| Storage Temperature | TSTG | -20 | +70 | °C | — |

Note 1: All the above voltages are on the basis of "VSS = 0V".

Note 2: When this module is used beyond the above absolute maximum ratings, permanent breakage of the module may occur. Also, for normal operations, it is desirable to use this module under the conditions according to Section 6 "Electrical Characteristics". If this module is used beyond these conditions, malfunctioning of the module can occur and the reliability of the module may deteriorate.

5.2 Touch Panel Controller FT6336U

| Parameter | Symbol | Min | Max | Unit | Notes |
|----------------------|--------|-----|-----|------|-------|
| Power Supply Voltage | VDD | 0 | 3.6 | V | 1 |

Note 1: If used beyond the absolute maximum ratings, CTP IC may be permanently damaged. It is strongly recommended that the device be used within the electrical characteristics in normal operations. If exposed to the condition not within the electrical characteristics, it may affect the reliability of the device.

6. Electrical Characteristics

6.1 DC Electrical Characteristics

| Item | Symbol | Condition | Min | Typ | Max | Unit |
|-----------------------------------|------------|-----------|---------|------|---------|------|
| Supply Voltage for Logic | VDD | — | 2.8 | 3.0 | 3.3 | V |
| Supply Voltage for Display | VCC | — | 7.0 | 12.5 | 13.0 | V |
| High Level Input | VIH | — | 0.8×VDD | — | — | V |
| Low Level Input | VIL | — | — | — | 0.2×VDD | V |
| High Level Output | VOH | — | 0.9×VDD | — | — | V |
| Low Level Output | VOL | — | — | — | 0.1×VDD | V |
| 50% Check Board operating Current | VCC =12.5V | — | — | 15 | 30 | mA |

Notes: The VCC (VPP) value can be adjusted according to the demand brightness. When VCC (VPP) is lowered, the brightness decreases or when VCC (VPP) is increased, the brightness increases. The VCC (VPP) value is set within the recommended range. The life time of OLED is directly related to the set brightness, and lower brightness helps to improve the life time.

6.2 Touch Panel Controller FT6336U

| Item | Symbol | Condition | Min | Typ | Max | Unit |
|-------------------|--------|-----------|---------|-----|---------|------|
| Supply Voltage | VDD | — | 2.8 | 3.0 | 3.3 | V |
| Input High Volt. | VIH | — | 0.7×VDD | — | VDD | V |
| Input Low Volt. | VIL | — | -0.3 | — | 0.3×VDD | V |
| Output High Volt. | VOH | — | 0.7×VDD | — | — | V |
| Output Low Volt. | VOL | — | — | — | 0.3×VDD | V |

6.3 OLED DISPLAY's Initial code

```
void Initial_SSD1309(){  
    Write_command(0xAE); // Display Off  
  
    Write_command(0xA8); // Select Multiplex Ratio  
    Write_command(0x3F); // Default => 0x3F (1/64 Duty) 0x1F(1/32 Duty)  
  
    Write_command(0xD3); //Setting Display Offset  
    Write_command(0x00); //00H Reset  
  
    Write_command(0x20); //Set Memory Addressing Mode  
    Write_command(0x02); //Page Addressing Mode  
  
    Write_command(0x00); //Set Column Address LSB  
  
    Write_command(0x10); //Set Column Address MSB  
  
    Write_command(0x40); //Set Display Start Line  
  
    Write_command(0xA6); //Set Normal Display  
  
    Write_command(0xDB); //Set Deselect Vcomh level  
    Write_command(0x3C); //~0.83xVCC  
  
    Write_command(0xA4); //Entire Display ON  
  
    Write_command(0x81); //Set Contrast Control  
    Write_command(0x6F);  
  
    Write_command(0xD5); //SET DISPLAY CLOCK  
    Write_command(0xC0); //105HZ  
  
    Write_command(0xA1); //0xA1 => Column Address is 127 Mapped to SEG0  
    //0xA0 => Column Address is 0 Mapped to SEG127  
  
    Write_command(0xC8); //0xC8 => Scan from COM[N-1] to 0  
    //0xC0 => Scan from 0 to COM[N-1]  
  
    Write_command(0xDA); //Set COM Hardware Configuration  
    Write_command(0x12); //Alternative COM Pin  
  
    Write_command(0xD9); //Set Pre-Charge period  
    Write_command(0xF1);  
  
    Write_command(0xAF); // Display ON  
}
```

Note 1: Initial code is for reference only. Please make the best adjustment with the OLED module.
Note 2: Command: Set Contrast Control (0x81) , This command sets the Contrast Setting of the display. The chip has 256 contrast steps from 00h to FFh. The segment output current increases as the contrast step value increases. The segment current increases, the OLED brightness increases.

I2C-bus data format

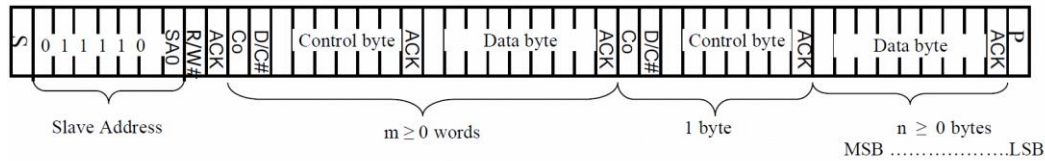

Note:

- Co – Continuation bit
- D/C# – Data / Command Selection bit
- ACK – Acknowledgement
- SA0 – Slave address bit
- R/W# – Read / Write Selection bit
- S – Start Condition / P – Stop Condition

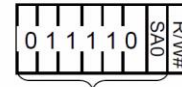

Slave Address

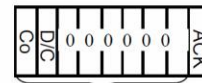

Control byte

(a) I2C address bit (SA0)

The slave address is following the start condition for recognition use. The slave address is either “b0111100” or “b0111101” by changing the SA0 to LOW or HIGH (D/C pin acts as SA0).

(b) “R/W#” bit is used to determine the operation mode of the I2C-bus interface. R/W#=1, it is in read mode. R/W#=0, it is in write mode.

(c) After the transmission of the slave address, either the control byte or the data byte may be sent across the SDA. A control byte mainly consists of Co and D/C# bits following by six “0”s.

- a. If the Co bit is set as logic “0”, the transmission of the following information will contain data bytes only.
- b. The D/C# bit determines the next data byte is acted as a command or a data. If the D/C# bit is set to logic “0”, it defines the following data byte as a command. If the D/C# bit is set to logic “1”, it defines the following data byte as a data which will be stored at the GDDRAM. The GDDRAM column address pointer will be increased by one automatically after each data write.

6.4 TOUCH PANEL's application code.

6.4.1 I2C address format

I2C slave addresses: 0x70

6.4.2 I2C Read/Write Interface description

The I2C is always configured in the Slave mode.

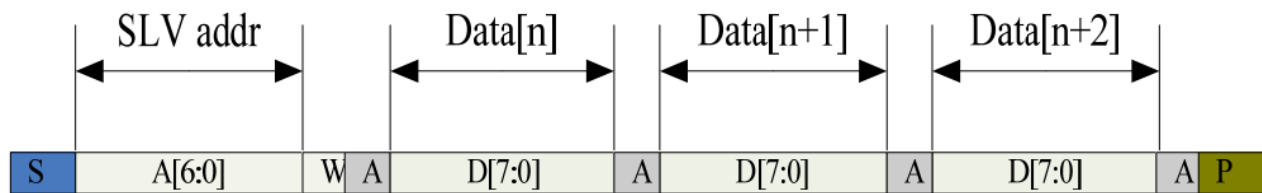
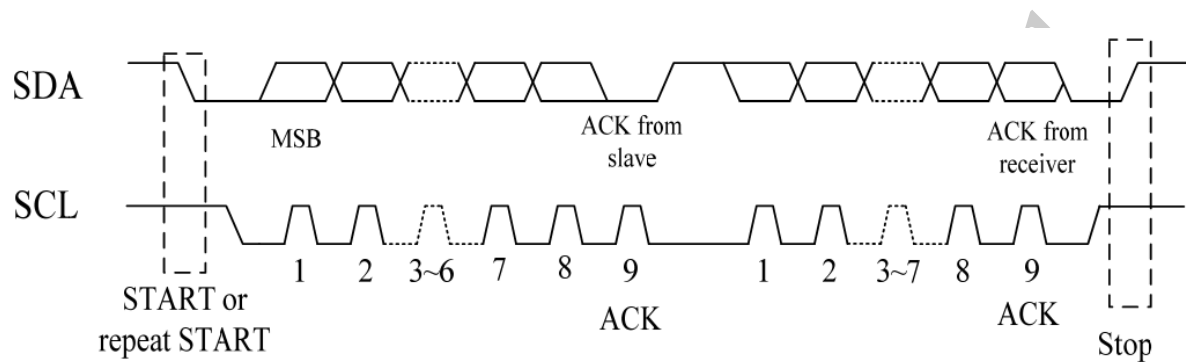

I2C master write, slave read (Slave address: 0x71)

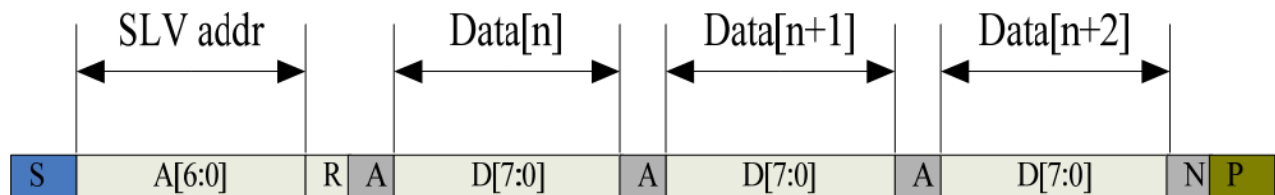

I2C master read, slave write (Slave address: 0x70)

Mnemonics Description

| Mnemonics | Description |
|-----------|--|
| S | I2C Start or I2C Restart |
| A[6:0] | Slave address |
| R/W | READ/WRITE bit, '1' for read, '0' for write |
| A(N) | ACK(NACK) |
| P | STOP: the indication of the end of a packet (if this bit is missing, S will indicate the end of the current packet and the beginning of the next packet) |

Timing Characteristics

| Parameter | Min | Max | Unit |
|--|-----|-----|------|
| SCL frequency | 10 | 400 | KHz |
| Bus free time between a STOP and START condition | 4.7 | \ | us |
| Hold time (repeated) START condition | 4.0 | \ | us |
| Data setup time | 250 | \ | ns |
| Setup time for a repeated START condition | 4.7 | \ | us |
| Setup Time for STOP condition | 4.0 | \ | us |

6.4.3 Coordinates Information

| Address | Name | Default Value | Bit7 | Bit6 | Bit5 | Bit4 | Bit3 | Bit2 | Bit1 | Bit0 | Host Access |
|---------|-----------|---------------|--|------|------|------|--|------|------|------|-------------|
| 0x02 | TD_STATUS | 0x00 | | | | | [3:0] Number of touch points | | | | R |
| 0x03 | P1_XH | 0xFF | [7:6] 1 st Event Flag | | | | [3:0] 1 st Touch X Position[11:8] | | | | R |
| 0x04 | P1_XL | 0xFF | [7:0] 1 st Touch X Position | | | | | | | | R |
| 0x05 | P1_YH | 0xFF | [7:4] 1 st Touch ID | | | | [3:0] 1 st Touch Y Position[11:8] | | | | R |
| 0x06 | P1_YL | 0xFF | [7:0] 1 st Touch Y Position | | | | | | | | R |

TD_STATUS

This register is the Touch Data status register.

| Address | Bit Address | Register Name | Description |
|---------|-------------|------------------------------|--|
| 0x02 | 3:0 | Number of touch points [3:0] | The detected point number, 1-2 is valid. |
| | 7:4 | Reserved | |

P1_XH

This register describes MSB of the X coordinate of the nth touch point and the corresponding event flag.

| Address | Bit Address | Register Name | Description |
|---------|-------------|-------------------------|-----------------------------------|
| 0x03 | 7:6 | Event Flag | 00b: Press Down |
| | | | 01b: Lift Up |
| | | | 10b: Contact |
| | | | 11b: No event |
| | | | Reserved |
| | 3:0 | Touch X Position [11:8] | MSB of Touch X Position in pixels |

P1_XL

This register describes LSB of the X coordinate of the nth touch point.

| Address | Bit Address | Register Name | Description |
|---------|-------------|------------------------|---------------------------------------|
| 0x04 | 7:0 | Touch X Position [7:0] | LSB of the Touch X Position in pixels |

P1_YH

This register describes MSB of the Y coordinate of the nth touch point and corresponding touch ID.

| Address | Bit Address | Register Name | Description |
|---------|-------------|-------------------------|--|
| 0x05 | 7:4 | Touch ID[3:0] | Touch ID of Touch Point, this value is 0x0F when the ID is invalid |
| | 3:0 | Touch Y Position [11:8] | MSB of Touch Y Position in pixels |

P1_YL

This register describes LSB of the Y coordinate of the nth touch point.

| Address | Bit Address | Register Name | Description |
|---------|-------------|------------------------|---------------------------------------|
| 0x06 | 7:0 | Touch Y Position [7:0] | LSB of the Touch Y Position in pixels |

Note: X-Y Resolutions: 128 x 64

7. Optical Characteristics

| Item | Symbol | Condition | Min | Typ | Max | Unit |
|--|--------------|-----------|----------|------|------|-------------------|
| View Angle | (V) θ | — | 160 | — | — | deg |
| | (H) ϕ | — | 160 | — | — | deg |
| Contrast Ratio | CR | Dark | 10,000:1 | — | — | — |
| Response Time | T rise | — | — | 10 | — | μ s |
| | T fall | — | — | 10 | — | μ s |
| Display with 50% check Board Brightness ⁽¹⁾ | | | 100 | 120 | — | cd/m ² |
| CIEx(White) | | (CIE1931) | 0.26 | 0.28 | 0.30 | — |
| CIEy(White) | | (CIE1931) | 0.30 | 0.32 | 0.34 | — |

Note1: The brightness value is based on the setting of VCC(VPP) equal to the Typical value.

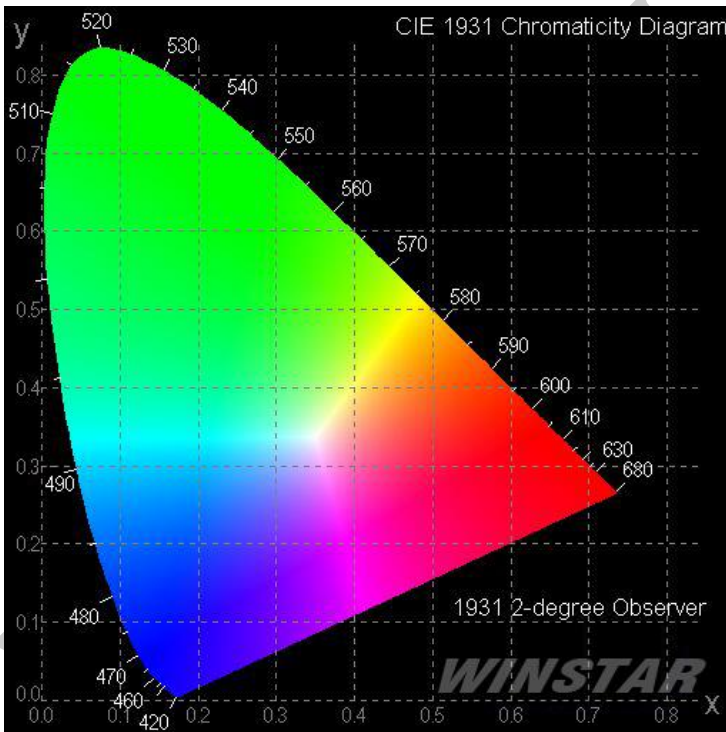

8.OLED Lifetime

| ITEM | Conditions | Min | Typ | Remark |
|---------------------|--|------------|-----|--------|
| Operating Life Time | Ta=25°C / Initial 50% checkerboard brightness 100cd/m ² | 20,000 Hrs | — | Note |

Note:

1. Lifetime is defined the amount of time when the luminance has decayed to <50% of the minimal brightness.
2. This analysis method uses life data obtained under accelerated conditions to extrapolate an estimated probability density function (*pdf*) for the product under normal use conditions.
3. Screen saving mode will extend OLED lifetime.
4. Lifetime is not guaranteed one but expected lifetime in normal condition.

9. Reliability

Content of Reliability Test

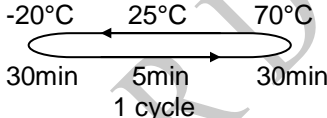
| Environmental Test | | | |
|--------------------------------------|--|---|---------------------|
| Test Item | Content of Test | Test Condition | Applicable Standard |
| High Temperature storage | Endurance test applying the high storage temperature for a long time. | 70°C 240hrs | — |
| Low Temperature storage | Endurance test applying the low storage temperature for a long time. | -20°C 240hrs | — |
| High Temperature Operation | Endurance test applying the electric stress (Voltage & Current) and the thermal stress to the element for a long time. | 60°C 240hrs | — |
| Low Temperature Operation | Endurance test applying the electric stress under low temperature for a long time. | -10°C 240hrs | — |
| High Temperature/ Humidity Storage | Endurance test applying the high temperature and high humidity storage for a long time. | 60°C,90%RH 240hrs | — |
| High Temperature/ Humidity Operation | Endurance test applying the high temperature and high humidity Operation for a long time. | 60°C,90%RH 120hrs | — |
| Temperature Cycle | Endurance test applying the low and high temperature cycle.  | -20°C /70°C 30 cycles | — |
| Mechanical Test | | | |
| Vibration test | Endurance test applying the vibration during transportation and using. | Frequency:10~55Hz amplitude:1.5mm Time:0.5hrs/axis Test axis:X,Y,Z | — |
| Others | | | |
| Static electricity test | Endurance test applying the electric stress to the finished product housing. | Air Discharge model ±4kv,10 times | — |

*** Supply voltage for OLED system =Operating voltage at 25°C

Test and measurement conditions

1. All measurements shall not be started until the specimens attain to temperature stability. After the completion of the described reliability test, the samples were left at room temperature for 2 hrs prior to conducting the functional test at $23\pm 5^{\circ}\text{C}$; $55\pm 15\%$ RH.
2. All-pixels on/off exchange is used as operation test pattern.
3. The degradation of Polarizer are ignored for High Temperature storage, High Temperature/ Humidity Storage, Temperature Cycle.
4. No Condensation.

Evaluation criteria

1. The function test is OK.
2. No observable defects.
3. Luminance: $> 50\%$ of initial value.
4. Current consumption: within $\pm 50\%$ of initial value.

APPENDIX:

RESIDUE IMAGE

Because the pixels are lighted in different time, the luminance of active pixels may reduce or differ from inactive pixels. Therefore, the residue image will occur. To avoid the residue image, every pixel needs to be lighted up uniformly.

10. Inspection specification

Inspection Standard:

MIL-STD-105E table normal inspection single sample level II.

Definition

1 Major defect : The defect that greatly affect the usability of product.

2 Minor defect : The other defects, such as cosmetic defects, etc.

Definition of inspection zone:

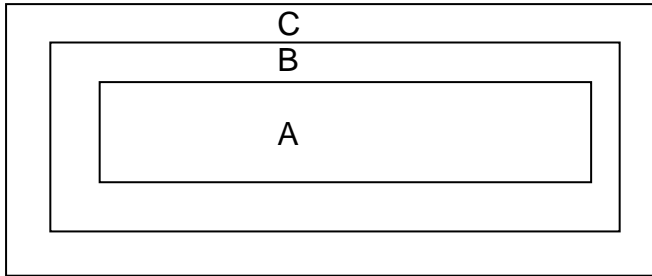

Zone A: Active Area

Zone B: Viewing Area except Zone A

Zone C: Outside Viewing Area

Note: As a general rule, visual defects in Zone C are permissible, when it is no trouble of quality and assembly to customer's product.

Inspection Methods

1 The general inspection : Under fluorescent light illumination: 750~1500 Lux, about 30cm viewing distance, within 45° viewing angle, under 25±5°C.

2 The luminance and color coordinate inspection : By SR-3 or BM-7 or the equal equipments, in the dark room, under 25±5°C.

| NO | Item | Criterion | AQL |
|----|---|---|------|
| 01 | Electrical Testing | 1.1 Missing vertical, horizontal segment, segment contrast defect. 1.2 Missing character , dot or icon. 1.3 Display malfunction. 1.4 No function or no display. 1.5 Current consumption exceeds product specifications. 1.6 OLED viewing angle defect. 1.7 Mixed product types. 1.8 Contrast defect. | 0.65 |
| 02 | Black or white spots on OLED (display only) | 2.1 White and black spots on display $\leq 0.25\text{mm}$, no more than three white or black spots present. 2.2 Densely spaced: No more than two spots or lines within 3mm. | 2.5 |

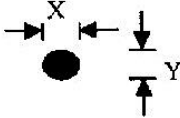
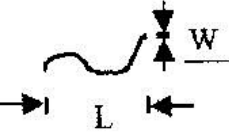
| NO | Item | Criterion | AQL | | | | | | | | | | | | | | | | | | | |
|-------------------------|--|--|----------------|----------------|----------------|------------------|--------|---------------|-------------------------|-----|--------------|-------------------------|---|------|---------------|----------------------|------|-----------|------------|---------------|-----|-----|
| 03 | OLED black spots, white spots, contamination (non-display) | 3.1 Round type : As following drawing $\Phi = (x + y) / 2$  <table border="1" data-bbox="738 304 1404 556"> <thead> <tr> <th>SIZE</th> <th>Acceptable QTY</th> <th>Zone</th> </tr> </thead> <tbody> <tr> <td>$\Phi \leq 0.10$</td> <td>ignore</td> <td>A+ B</td> </tr> <tr> <td>$0.10 < \Phi \leq 0.20$</td> <td>2</td> <td>A+ B</td> </tr> <tr> <td>$0.20 < \Phi \leq 0.25$</td> <td>1</td> <td>A+ B</td> </tr> <tr> <td>$0.25 < \Phi$</td> <td>0</td> <td>A+ B</td> </tr> </tbody> </table> | SIZE | Acceptable QTY | Zone | $\Phi \leq 0.10$ | ignore | A+ B | $0.10 < \Phi \leq 0.20$ | 2 | A+ B | $0.20 < \Phi \leq 0.25$ | 1 | A+ B | $0.25 < \Phi$ | 0 | A+ B | 2.5 | | | | |
| | | SIZE | Acceptable QTY | Zone | | | | | | | | | | | | | | | | | | |
| $\Phi \leq 0.10$ | ignore | A+ B | | | | | | | | | | | | | | | | | | | | |
| $0.10 < \Phi \leq 0.20$ | 2 | A+ B | | | | | | | | | | | | | | | | | | | | |
| $0.20 < \Phi \leq 0.25$ | 1 | A+ B | | | | | | | | | | | | | | | | | | | | |
| $0.25 < \Phi$ | 0 | A+ B | | | | | | | | | | | | | | | | | | | | |
| | | 3.2 Line type : (As following drawing)  <table border="1" data-bbox="609 913 1404 1165"> <thead> <tr> <th>Length</th> <th>Width</th> <th>Acceptable QTY</th> <th>Zone</th> </tr> </thead> <tbody> <tr> <td>---</td> <td>$W \leq 0.02$</td> <td>ignore</td> <td>A+B</td> </tr> <tr> <td>$L \leq 3.0$</td> <td>$0.02 < W \leq 0.03$</td> <td rowspan="2">2</td> <td>A+B</td> </tr> <tr> <td>$L \leq 2.5$</td> <td>$0.03 < W \leq 0.05$</td> <td>A+B</td> </tr> <tr> <td>---</td> <td>$0.05 < W$</td> <td>As round type</td> <td></td> </tr> </tbody> </table> | Length | Width | Acceptable QTY | Zone | --- | $W \leq 0.02$ | ignore | A+B | $L \leq 3.0$ | $0.02 < W \leq 0.03$ | 2 | A+B | $L \leq 2.5$ | $0.03 < W \leq 0.05$ | A+B | --- | $0.05 < W$ | As round type | | 2.5 |
| Length | Width | Acceptable QTY | Zone | | | | | | | | | | | | | | | | | | | |
| --- | $W \leq 0.02$ | ignore | A+B | | | | | | | | | | | | | | | | | | | |
| $L \leq 3.0$ | $0.02 < W \leq 0.03$ | 2 | A+B | | | | | | | | | | | | | | | | | | | |
| $L \leq 2.5$ | $0.03 < W \leq 0.05$ | | A+B | | | | | | | | | | | | | | | | | | | |
| --- | $0.05 < W$ | As round type | | | | | | | | | | | | | | | | | | | | |
| 04 | Polarizer bubbles /Dent | 4.1 If bubbles are visible, judge using black spot specifications, not easy to find, must check in specify direction. <table border="1" data-bbox="730 1312 1404 1564"> <thead> <tr> <th>Size Φ</th> <th>Acceptable QTY</th> <th>Zone</th> </tr> </thead> <tbody> <tr> <td>$\Phi \leq 0.20$</td> <td>ignore</td> <td>A+B</td> </tr> <tr> <td>$0.20 < \Phi \leq 0.50$</td> <td>3</td> <td>A+B</td> </tr> <tr> <td>$0.50 < \Phi \leq 1.00$</td> <td>2</td> <td>A+B</td> </tr> <tr> <td>$1.00 < \Phi$</td> <td>0</td> <td>A+B</td> </tr> <tr> <td>Total QTY</td> <td>3</td> <td></td> </tr> </tbody> </table> 4.2 The polarizer dent follows this specification. | Size Φ | Acceptable QTY | Zone | $\Phi \leq 0.20$ | ignore | A+B | $0.20 < \Phi \leq 0.50$ | 3 | A+B | $0.50 < \Phi \leq 1.00$ | 2 | A+B | $1.00 < \Phi$ | 0 | A+B | Total QTY | 3 | | 2.5 | |
| Size Φ | Acceptable QTY | Zone | | | | | | | | | | | | | | | | | | | | |
| $\Phi \leq 0.20$ | ignore | A+B | | | | | | | | | | | | | | | | | | | | |
| $0.20 < \Phi \leq 0.50$ | 3 | A+B | | | | | | | | | | | | | | | | | | | | |
| $0.50 < \Phi \leq 1.00$ | 2 | A+B | | | | | | | | | | | | | | | | | | | | |
| $1.00 < \Phi$ | 0 | A+B | | | | | | | | | | | | | | | | | | | | |
| Total QTY | 3 | | | | | | | | | | | | | | | | | | | | | |
| 05 | Scratches | Follow NO.3 OLED black spots, white spots, contamination. | | | | | | | | | | | | | | | | | | | | |

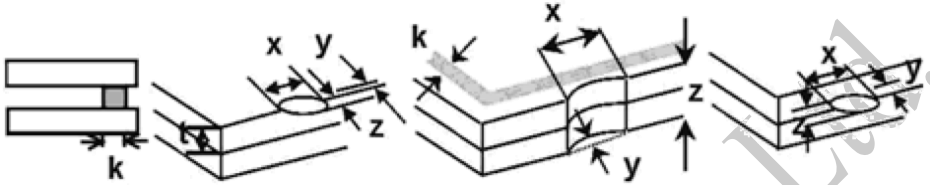
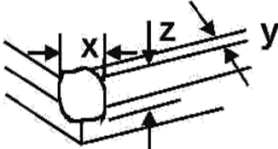
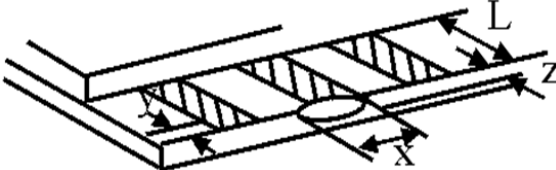
| NO | Item | Criterion | AQL | | | | | | | | | | | | | | | | | | |
|--------------------|-----------------------|--|-------------------|----------------|-------------------|----------------|-----------------------|----------------|--------------------|-----------------|---------------|-------------------|---------------|----------------|---------------|-----------------------|---------------|--------------------|-----------------|---------------|-----|
| 06 | Chipped glass | <p>Symbols Define: x: Chip length y: Chip width z: Chip thickness k: Seal width t: Glass thickness a: OLED side length L: Electrode pad length: 6.1 General glass chip : 6.1.1 Chip on panel surface and crack between panels:</p>  <table border="1" data-bbox="474 653 1377 779"> <tr> <td>z: Chip thickness</td> <td>y: Chip width</td> <td>x: Chip length</td> </tr> <tr> <td>$Z \leq 1/2t$</td> <td>Not over viewing area</td> <td>$x \leq 1/8a$</td> </tr> <tr> <td>$1/2t < z \leq 2t$</td> <td>Not exceed 1/3k</td> <td>$x \leq 1/8a$</td> </tr> </table> <p>⊙ If there are 2 or more chips, x is total length of each chip.</p> <p>6.1.2 Corner crack:</p>  <table border="1" data-bbox="474 1045 1395 1171"> <tr> <td>z: Chip thickness</td> <td>y: Chip width</td> <td>x: Chip length</td> </tr> <tr> <td>$Z \leq 1/2t$</td> <td>Not over viewing area</td> <td>$x \leq 1/8a$</td> </tr> <tr> <td>$1/2t < z \leq 2t$</td> <td>Not exceed 1/3k</td> <td>$x \leq 1/8a$</td> </tr> </table> <p>⊙ If there are 2 or more chips, x is the total length of each chip.</p> | z: Chip thickness | y: Chip width | x: Chip length | $Z \leq 1/2t$ | Not over viewing area | $x \leq 1/8a$ | $1/2t < z \leq 2t$ | Not exceed 1/3k | $x \leq 1/8a$ | z: Chip thickness | y: Chip width | x: Chip length | $Z \leq 1/2t$ | Not over viewing area | $x \leq 1/8a$ | $1/2t < z \leq 2t$ | Not exceed 1/3k | $x \leq 1/8a$ | 2.5 |
| z: Chip thickness | y: Chip width | x: Chip length | | | | | | | | | | | | | | | | | | | |
| $Z \leq 1/2t$ | Not over viewing area | $x \leq 1/8a$ | | | | | | | | | | | | | | | | | | | |
| $1/2t < z \leq 2t$ | Not exceed 1/3k | $x \leq 1/8a$ | | | | | | | | | | | | | | | | | | | |
| z: Chip thickness | y: Chip width | x: Chip length | | | | | | | | | | | | | | | | | | | |
| $Z \leq 1/2t$ | Not over viewing area | $x \leq 1/8a$ | | | | | | | | | | | | | | | | | | | |
| $1/2t < z \leq 2t$ | Not exceed 1/3k | $x \leq 1/8a$ | | | | | | | | | | | | | | | | | | | |
| 06 | Glass crack | <p>Symbols : x: Chip length y: Chip width z: Chip thickness k: Seal width t: Glass thickness a: OLED side length L: Electrode pad length 6.2 Protrusion over terminal : 6.2.1 Chip on electrode pad :</p>  <table border="1" data-bbox="474 1711 1377 1795"> <tr> <td>y: Chip width</td> <td>x: Chip length</td> <td>z: Chip thickness</td> </tr> <tr> <td>$y \leq 0.5mm$</td> <td>$x \leq 1/8a$</td> <td>$0 < z \leq t$</td> </tr> </table> | y: Chip width | x: Chip length | z: Chip thickness | $y \leq 0.5mm$ | $x \leq 1/8a$ | $0 < z \leq t$ | 2.5 | | | | | | | | | | | | |
| y: Chip width | x: Chip length | z: Chip thickness | | | | | | | | | | | | | | | | | | | |
| $y \leq 0.5mm$ | $x \leq 1/8a$ | $0 < z \leq t$ | | | | | | | | | | | | | | | | | | | |

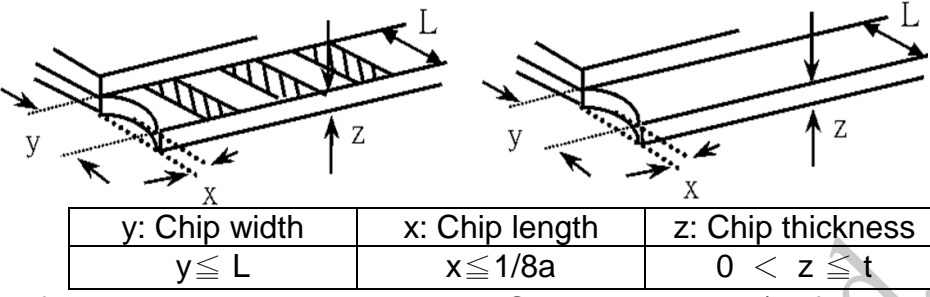
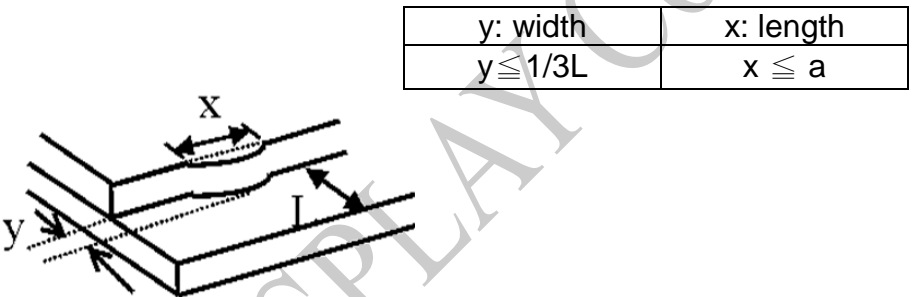
| NO | Item | Criterion | AQL |
|----|--------------------|---|---|
| 06 | Glass crack | <p>6.2.2 Non-conductive portion:</p>  <p>⊙ If the chipped area touches the ITO terminal, over 2/3 of the ITO must remain and be inspected according to electrode terminal specifications.</p> <p>⊙ If the product will be heat sealed by the customer, the alignment mark not be damaged.</p> <p>6.2.3 Substrate protuberance and internal crack.</p>  | 2.5 |
| 07 | Cracked glass | The OLED with extensive crack is not acceptable. | 2.5 |
| 08 | Backlight elements | <p>8.1 Illumination source flickers when lit.</p> <p>8.2 Spots or scratched that appear when lit must be judged. Using OLED spot, lines and contamination standards.</p> <p>8.3 Backlight doesn't light or color wrong.</p> | 0.65 2.5 0.65 |
| 09 | Bezel | <p>9.1 Bezel may not have rust, be deformed or have fingerprints, stains or other contamination.</p> <p>9.2 Bezel must comply with job specifications.</p> | 2.5 0.65 |
| 10 | PCB , COB | <p>10.1 COB seal may not have pinholes larger than 0.2mm or contamination.</p> <p>10.2 COB seal surface may not have pinholes through to the IC.</p> <p>10.3 The height of the COB should not exceed the height indicated in the assembly diagram.</p> <p>10.4 There may not be more than 2mm of sealant outside the seal area on the PCB. And there should be no more than three places.</p> <p>10.5 No oxidation or contamination PCB terminals.</p> <p>10.6 Parts on PCB must be the same as on the production characteristic chart. There should be no wrong parts, missing parts or excess parts.</p> <p>10.7 The jumper on the PCB should conform to the product characteristic chart.</p> <p>10.8 If solder gets on bezel tab pads, OLED pad, zebra pad or</p> | 2.5 2.5 0.65 2.5 2.5 0.65 0.65 2.5 |

| | | | |
|--|--|--|--|
| | | screw hold pad, make sure it is smoothed down. | |
|--|--|--|--|

WINSTAR DISPLAY Co., Ltd.

| NO | Item | Criterion | AQL |
|----|--------------------|---|---|
| 11 | Soldering | 11.1 No un-melted solder paste may be present on the PCB. 11.2 No cold solder joints, missing solder connections, oxidation or icicle. 11.3 No residue or solder balls on PCB. 11.4 No short circuits in components on PCB. | 2.5 2.5 2.5 0.65 |
| 12 | General appearance | 12.1 No oxidation, contamination, curves or, bends on interface Pin (OLB) of TCP. 12.2 No cracks on interface pin (OLB) of TCP. 12.3 No contamination, solder residue or solder balls on product. 12.4 The IC on the TCP may not be damaged, circuits. 12.5 The uppermost edge of the protective strip on the interface pin must be present or look as if it cause the interface pin to sever. 12.6 The residual rosin or tin oil of soldering (component or chip component) is not burned into brown or black color. 12.7 Sealant on top of the ITO circuit has not hardened. 12.8 Pin type must match type in specification sheet. 12.9 OLED pin loose or missing pins. 12.10 Product packaging must the same as specified on packaging specification sheet. 12.11 Product dimension and structure must conform to product specification sheet. | 2.5 0.65 2.5 2.5 2.5 2.5 0.65 0.65 0.65 0.65 |

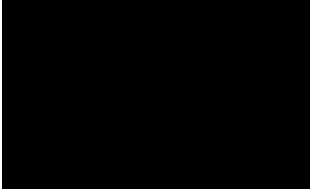
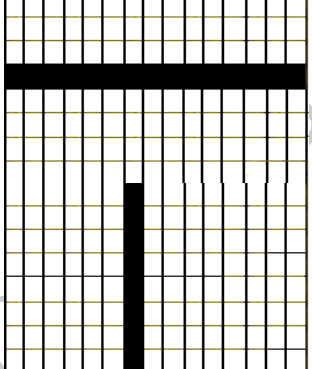
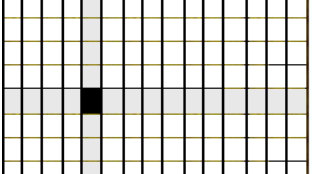
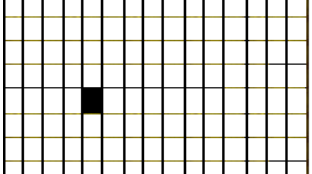
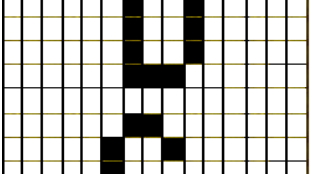
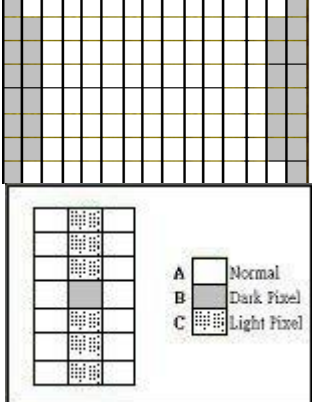
| Check Item | Classification | Criteria |
|--|----------------|---|
| No Display | Major |  |
| Missing Line | Major |  |
| Pixel Short | Major |  |
| Dark Pixel | Major |  |
| Wrong Display | Major |  |
| Un-uniform $B/A \times 100\% < 70\%$ $A/C \times 100\% < 70\%$ | Major |  |

11. Precautions in use of OLED Modules

Modules

- (1) Avoid applying excessive shocks to module or making any alterations or modifications to it.
- (2) Don't make extra holes on the printed circuit board, change the components or modify its shape of OLED display module.
- (3) Don't disassemble the OLED display module.
- (4) Do not apply input signals while the logic power is off.
- (5) Don't operate it above the absolute maximum rating.
- (6) Don't drop, bend or twist OLED display module.
- (7) Soldering: only to the I/O terminals.
- (8) Hot-Bar FPC soldering condition: 280~350C, less than 5 seconds.
- (9) Winstar has the right to change the passive components (Resistors, capacitors and other passive components will have different appearance and color caused by the different supplier.) and change the PCB Rev. (In order to satisfy the supplying stability, management optimization and the best product performance...etc, under the premise of not affecting the electrical characteristics and external dimensions, Winstar have the right to modify the version.)
- (10) Winstar has the right to upgrade or modify the product function.
- (11) For COG & COF structure OLED products, customers should reserve VCC (VPP) adjustment function or software update function when designing OLED supporting circuit. (The progress of OLED light-emitting materials will increase the conversion efficiency and the brightness. The brightness can be adjusted if necessary).

11.1. Handling Precautions

- (1) Since the display panel is being made of glass, do not apply mechanical impacts such as dropping from a high position.
- (2) If the display panel is broken by some accident and the internal organic substance leaks out, be careful not to inhale nor lick the organic substance.
- (3) If pressure is applied to the display surface or its neighborhood of the OLED display module, the cell structure may be damaged. So, be careful not to apply pressure to these sections.
- (4) The polarizer covering the surface of the OLED display module is soft and easily scratched.
- (5) When the surface of the polarizer of the OLED display module has soil, clean the surface. It takes advantage by using following adhesion tape.
 - * Scotch Mending Tape No. 810 or an equivalentNever try to breathe upon the soiled surface nor wipe the surface using cloth containing solvent such as ethyl alcohol, since the surface of the polarizer will become cloudy. Also, pay attention that the following liquid and solvent may spoil the polarizer:
 - * Water
 - * Ketone
 - * Aromatic Solvents
- (6) Protection film is being applied to the surface of the display panel and removes the protection film before assembling it. At this time, if the OLED display module has been stored for a long period of time, residue adhesive material of the protection film may remain on the surface of the display panel after removed of the film. In such case, remove the residue material by the method introduced in the above Section 5.
- (7) Do not touch the following sections whenever possible while handling the OLED display modules.
 - * Pins and electrodes

* Pattern layouts such as the TCP & FPC

- (8) Hold OLED display module very carefully when placing OLED display module into the System housing. Do not apply excessive stress or pressure to OLED display module. And, do not over bend the film with electrode pattern layouts. These stresses will influence the display performance. Also, secure sufficient rigidity for the outer cases.

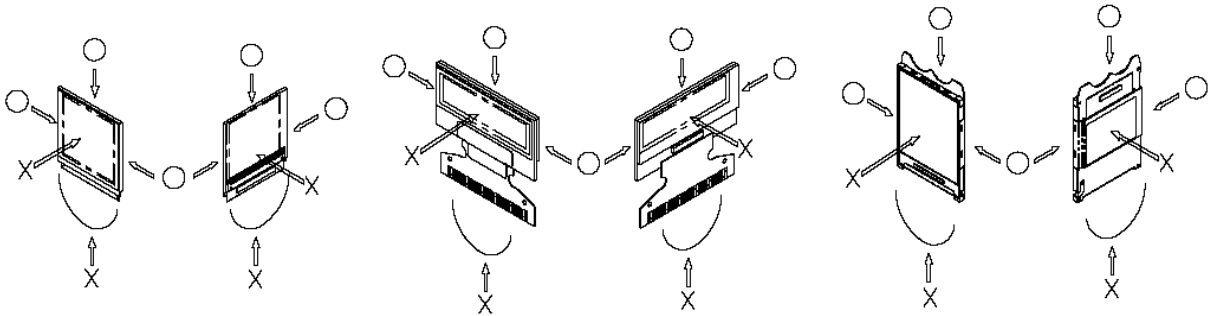

- (9) Do not apply stress to the LSI chips and the surrounding molded sections.
- (10) Pay sufficient attention to the working environments when handing OLED display modules to prevent occurrence of element breakage accidents by static electricity.
- * Be sure to make human body grounding when handling OLED display modules.
 - * Be sure to ground tools to use or assembly such as soldering irons.
 - * To suppress generation of static electricity, avoid carrying out assembly work under dry environments.
 - * Protective film is being applied to the surface of the display panel of the OLED display module. Be careful since static electricity may be generated when exfoliating the protective film.

11.2. Storage Precautions

- (1) When storing OLED display modules, put them in static electricity preventive bags to avoid be directly exposed to sun or lights of fluorescent lamps. And, also, place in the temperature $25\pm 5^{\circ}\text{C}$ and Humidity below 65% RH. (We recommend you to store these modules in the packaged state when they were shipped from Winstar. At that time, be careful not to let water drops adhere to the packages or bags.)
- (2) When the OLED display module is being dewed or when it is placed under high temperature or high humidity environments, the electrodes may be corroded if electric current is applied. Please store it in clean environment.

11.3. Designing Precautions

- (1) The absolute maximum ratings are the ratings which cannot be exceeded for OLED display module, and if these values are exceeded, OLED display module may be damaged.
- (2) To prevent occurrence of malfunctioning by noise, pay attention to satisfy the VIL and VIH specification and to make the signal line cable as short as possible.
- (3) We recommend you to install excess current preventive unit (fuses, etc.) to the power circuit (VDD / VCC). (Recommend value: 0.5A)
- (4) Pay sufficient attention to avoid occurrence of mutual noise interference with the nearby devices.
- (5) As for EMI, take necessary measures on the equipment side basically.
- (6) If the power supplied to the OLED display module is forcibly shut down by such errors as taking out the main battery while the OLED display panel is in operation, we cannot guarantee the quality of this OLED display module.
- * Connection (contact) to any other potential than the above may lead to rupture of the IC.

- (7) If this OLED driver is exposed to light, malfunctioning may occur and semiconductor elements may change their characteristics.
- (8) The internal status may be changed, if excessive external noise enters into the module. Therefore, it is necessary to take appropriate measures to suppress noise generation or to protect module from influences of noise on the system design.
- (9) We recommend you to make periodical refreshment of the operation statuses (re-setting of the commands and re-transference of the display data) to cope with catastrophic noise.
- (10) It's pretty common to use "Screen Saver" to extend the lifetime and Don't use the same image for long time in real application. When an OLED display module is operated for a long of time with fixed pattern, an afterimage or slight contrast deviation may occur.
- (11) The limitation of FPC and Film bending.

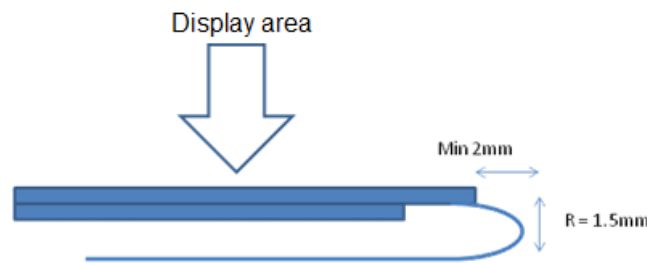

- (12) The module should be fixed balanced into the housing, or the module may be twisted.

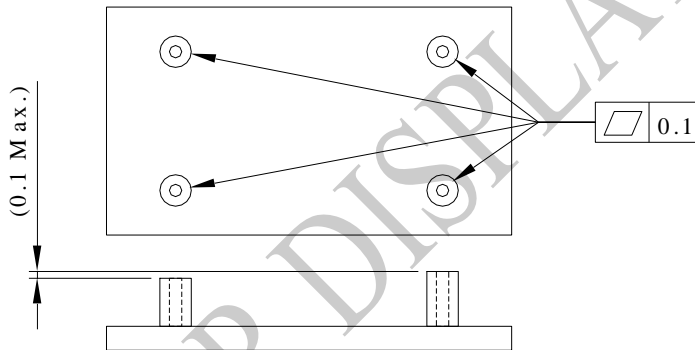

- (13) Please heat up a little the tape sticking on the components when removing it; otherwise the components might be damaged.

11.4. Precautions when disposing of the OLED display modules

- (1) Request the qualified companies to handle industrial wastes when disposing of the OLED display modules. Or, when burning them, be sure to observe the environmental and hygienic laws and regulations.