

Photo Interrupter

Item No.	DPI010600	Description	Photo Interrupter	Version	2
Page	1 of 8		Publish Date	Aug. 12, 2020	

● FUNCTIONS

1. Position detecting
2. Paper detecting
3. Signal detecting

● APPLICATIONS

1. Automatic control system
2. Automation Equipment
3. Scanner
4. Printer
5. Fax machine
6. Copy machine
7. Printing machine
8. PC mouse
9. Security system
10. Counter
11. Optical encoders
12. Other relevant detection about position detecting, paper detecting, signal detecting



● FEATURES

1. Simple structure, multi-stalling angles for option.
2. Housing made of high anti-tension industrial plastic, free from crack caused during installation.
3. Infrared LED emitting diode matches with phototransistor, free from interference of vision light.
4. Comply with RoHS.
5. Made in Taiwan.



Photo Interrupter

Item No.	DPI010600	Description	Photo Interrupter	Version	2
Page	2 of 8		Publish Date	Aug. 12, 2020	

● DIMENSIONS / OPERATION / P.C.B. LAYOUT (Unit: mm, Tolerance: ±0.25mm)

Fig. 1

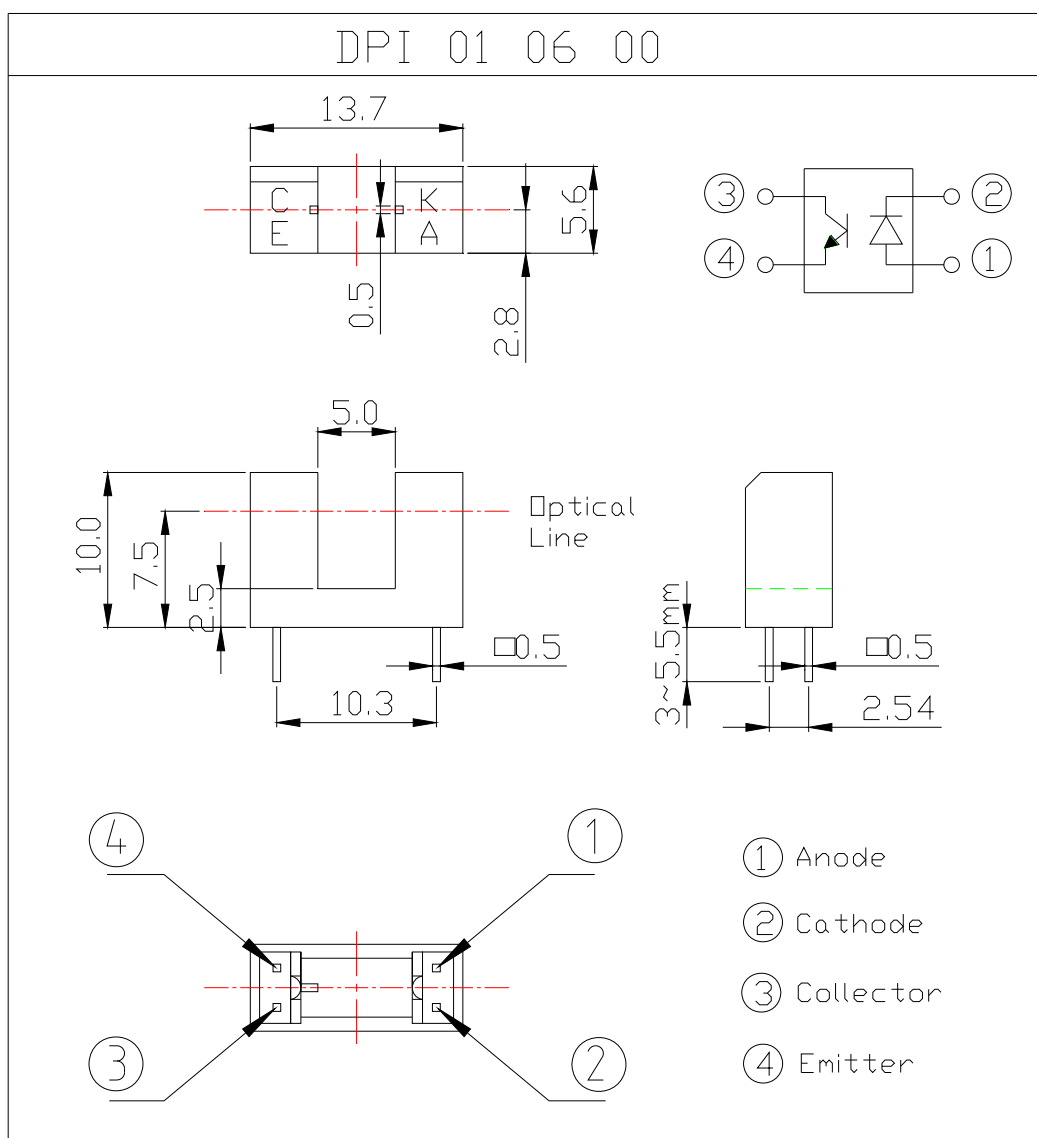

Photo Interrupter

Item No.	DPI010600	Description	Photo Interrupter	Version	2
Page	3 of 8		Publish Date	Aug. 12, 2020	

● Current/Voltage/Conditions Suggested

Input Current	Operating Voltage	Conditions
10 mA	5 V	$V_{CE}=5V$ $R_D=390\text{ ohm}$ $R_L=33K\text{ ohm}$

● Absolute Maximum Rating ($T_a=25^{\circ}C$)

Item		Symbol	Rating	Unit
Input	Power Dissipation	P_d	75	mW
	Reverse Voltage	V_R	5	V
	Forward Current	I_F	50	mA
	Peak Forward Current (*1) Pulse width $\leq 100\mu s$, Duty $\leq 1\%$.	I_{FP}	1	A
Output	Collector Power Dissipation	P_C	100	mW
	Collector Current	I_c	20	mA
	C-E Voltage	V_{CEO}	30	V
	E-C Voltage	V_{ECO}	5	V
Operating Temperature		T_{opr}	-25~+85	$^{\circ}C$
Storage Temperature		T_{stg}	-40~+100	$^{\circ}C$
Soldering Temperature (*2)		T_{sol}	260	$^{\circ}C$

Notes: (*1) $t_w=100\mu sec$, $T=10\text{ msec}$

(*2) $t=5\text{ Sec}$



Photo Interrupter

Item No.	DPI010600	Description	Photo Interrupter	Version	2
Page	4 of 8		Publish Date	Aug. 12, 2020	

● Electrical Optical Characteristics (Ta=25°C)

Parameter	Symbol	Condition	Min.	Typ.	Max.	Unit
Forward Voltage	V_F	$I_F=20mA$	-	1.2	1.5	V
Reverse Current	I_R	$V_R=5V$	-	-	10	μA
Peak Wavelength	λ_p	$I_F=10mA$		940		nm
Dark Current	I_{ceo}	$V_{CE}=10V$	-	-	100	nA
C-E Saturation Voltage	$V_{CE(sat)}$	$I_C=0.25mA$ $I_F=10mA$	-	-	0.4	V
Light Current	I_C	$V_{CE}=5V$ $I_F=10mA$	0.5	-	-	mA
Rise Time	T_r	$I_{FP}=20mA$ $V_{CE}=5V$	-	20	-	μsec
Fall Time	T_f	$R_L=1K\Omega$	-	20	-	μsec



Photo Interrupter

Item No.	DPI010600	Description	Photo Interrupter	Version	2
Page	5 of 8		Publish Date	Aug. 12, 2020	

● Typical Electrical / Optical Characteristics Curves (Ta=25°C)

Fig.1 Power Dissipation vs. Ambient Temperature

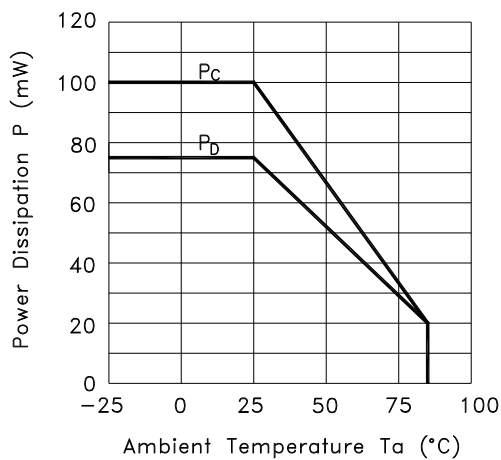

Fig.2 Forward Current vs. Forward Voltage

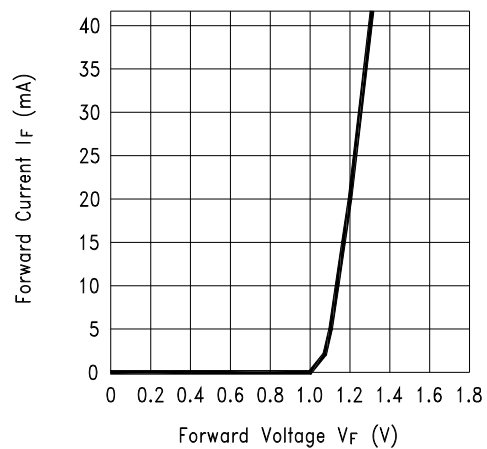

Fig.3 Collector Current vs. Collector-emitter Voltage

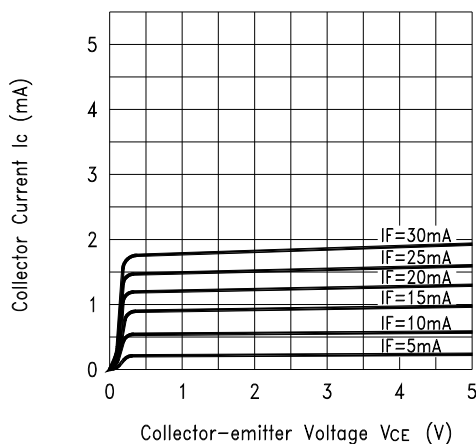

Fig.4 Collector Current vs. Ambient Temperature

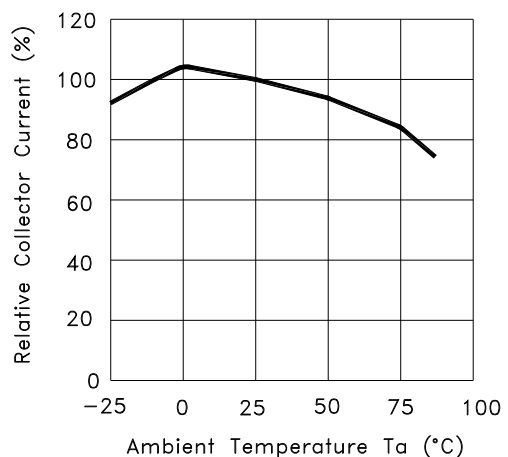

Photo Interrupter

Item No.	DPI010600	Description	Photo Interrupter	Version	2
Page	6 of 8		Publish Date	Aug. 12, 2020	

Fig.5 Collector-emitter Saturation Voltage vs. Ambient Temperature

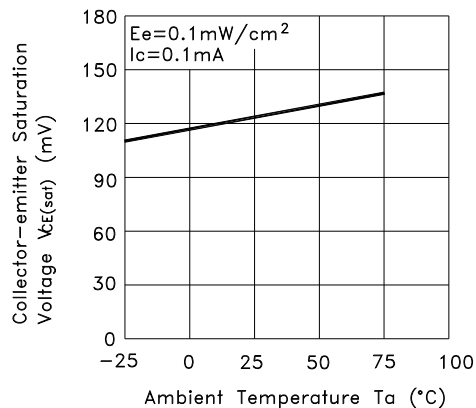

Fig.6 Response Time vs. Load Resistance

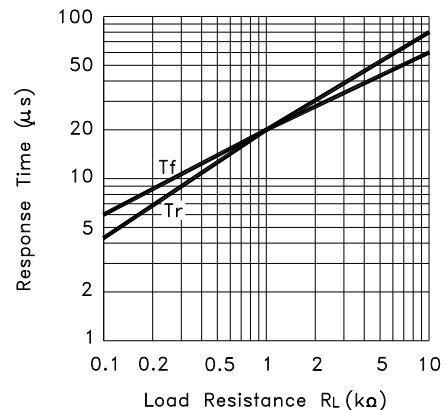
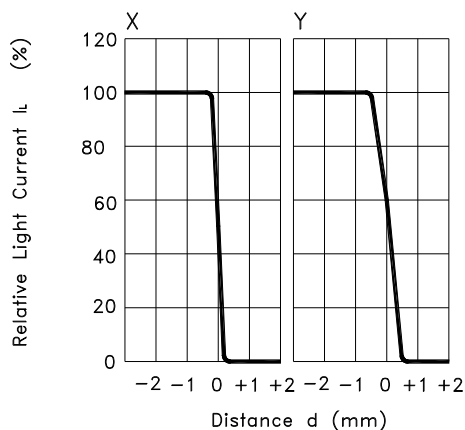
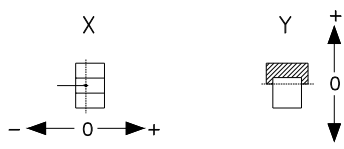

Fig.7 Sensing Position Characteristics (Typical)



(Center of Optical axis)



Test Circuit for Response Time

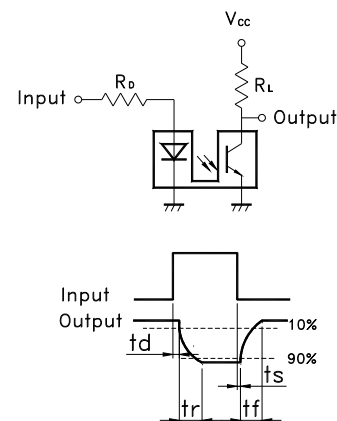

Photo Interrupter

Item No.	DPI010600	Description	Photo Interrupter	Version	2
Page	7 of 8		Publish Date	Aug. 12, 2020	

● PACKAGE

	Part Number	Package	Quantity	Total	Dimension (mm)
1.	DPI 010600	PE Bag	200 pcs	200 pcs	205L*145W
		Inner Box	8 Bags	1,600 pcs	348L*191W*85H
		Carton	3 Boxes	4,800 pcs	364L*278W*213H

※ Package shown as below for reference.



PE Bag

Inner Box

Carton



Photo Interrupter

Item No.	DPI010600	Description	Photo Interrupter	Version	2
Page	8 of 8		Publish Date	Aug. 12, 2020	

● **NOTES**

1. For the continued product improvement as one of the company policy, specifications may change or update without notice. The latest information can be obtained through our sales offices. Normally, all products are supplied under our standard conditions.

● **PRECAUTIONS FOR USE**

1. If the products is intended to be used for other endurance equipment requiring higher safety and reliability such as life support system, space and aviation devices, disaster and safety system, it's necessary to make verification of conformity or contact us for the details before using.
2. Do not try to clean the switch with a solvent or similar substance after the soldering process.
3. Use water-soluble flux may damage the switch.
4. Please follow the soldering instruction accordingly, otherwise might lead to defective.
5. Do not use switch in the environment of high humidity, because such an environment may cause the leakage current between the terminals.
6. Please do not exceed the rated load as there will be a risk of disabling the product function.

