

Tilt Sensor Switch

Item No.	RBS320103	Description	Photoelectric	Version	13
Page	1 of 9		Publish Date	Jun. 22, 2018	

● FUNCTIONS

1. One way tilt detection
2. Upside down detection
3. Rotation detection in vertical position

● APPLICATIONS

1. Anti-theft for motorbike



● FEATURES

1. Housing made of high insulation plastic material, free from electric conduction and rust problem.
2. Detecting with photo transistors, generating highly reliable and stable signals.
3. All plastic materials subject to industrial purpose, resist high temperature and meet fireproof function.
4. Simple ON and OFF signals, easy for design.
5. RoHS compliance, complete replacement of mercury switch.
6. A more economical tilt and vibration detection option than IC design solution.
7. Made in Taiwan and examined before shipment.

● PATENTS

1. Taiwan Patent NO. I 321332
2. U.S.A. Patent NO. US 7,485,818 B2
3. China Patent NO. ZL 200610078607.7



Tilt Sensor Switch

Item No.	RBS320103	Description	Photoelectric	Version	13
Page	2 of 9		Publish Date	Jun. 22, 2018	

● DIMENSIONS / OPERATION / P.C.B. LAYOUT (Unit: mm, Tolerance: ±0.25mm)

Fig. 1

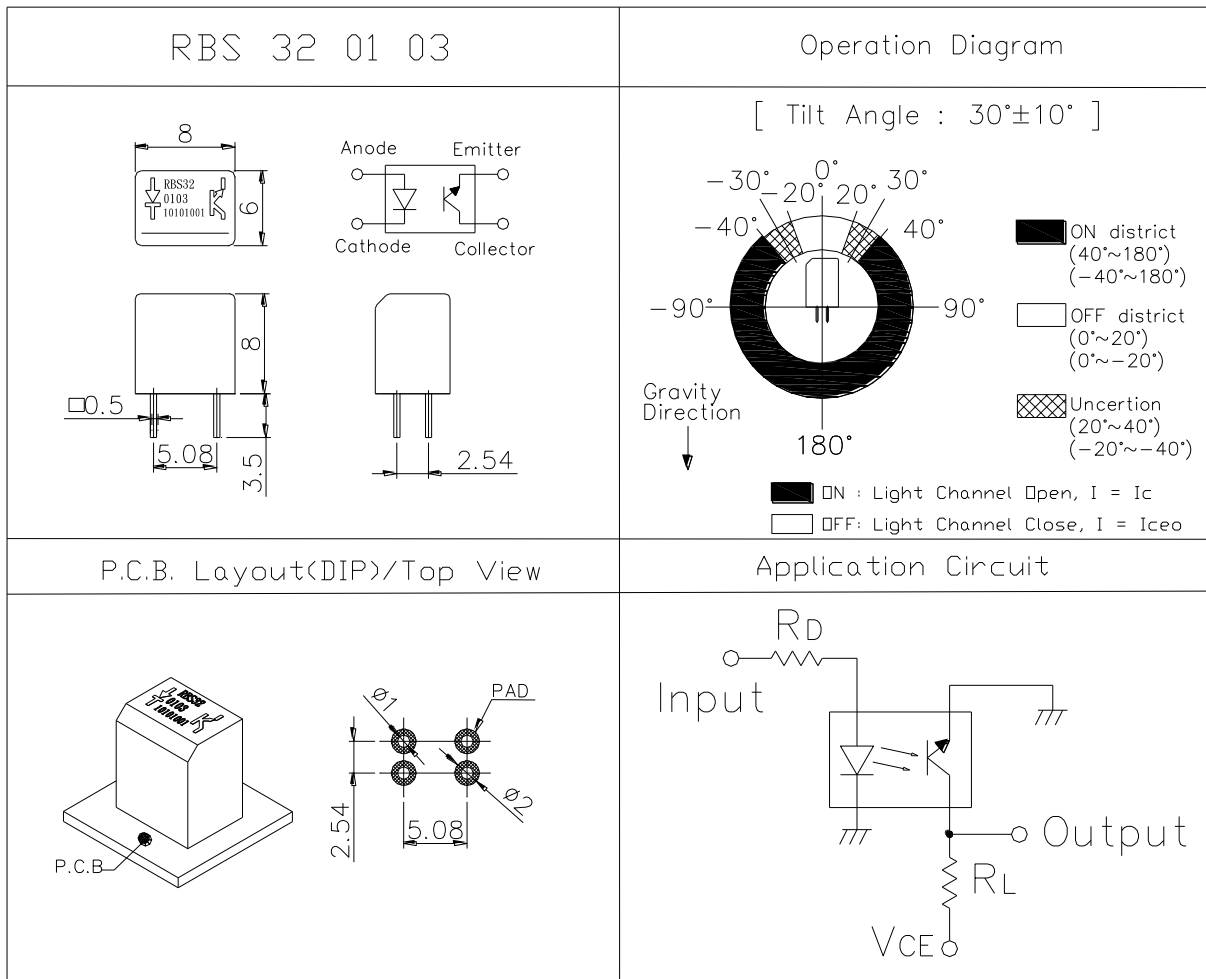

Tilt Sensor Switch

Item No.	RBS320103	Description	Photoelectric	Version	13
Page	3 of 9		Publish Date	Jun. 22, 2018	

● Current/Voltage Suggested

Input Current (mA)	Operating Voltage (V)	Condition
10	3.3	$V_{CE}=3.3V$ $R_D=200\text{ ohm}$ $R_L=15K\text{ ohm}$
10	5	$V_{CE}=5V$ $R_D=390\text{ ohm}$ $R_L=22K\text{ ohm}$

* Please refer to above Application Circuit for designing electrical circuit.

● Absolute Maximum Rating ($T_a=25^\circ\text{C}$)

Item		Symbol	Rating	Unit
Input	Power Dissipation	P_d	75	mW
	Reverse Voltage	V_R	5	V
	Forward Current	I_F	50	mA
	Peak Forward Current (*1)	I_{FP}	1	A
Output	Collector Power Dissipation	P_C	100	mW
	Collector Current	I_C	20	mA
	C-E Voltage	V_{CEO}	30	V
	E-C Voltage	V_{ECO}	5	V
Operating Temperature		T_{opr}	-25~+85	$^\circ\text{C}$
Storage Temperature		T_{stg}	-40~+85	$^\circ\text{C}$
Soldering Temperature (*2)		T_{sol}	260	$^\circ\text{C}$

(*1) $t_w=100\ \mu\text{Sec.}$, $T=10\ \text{mSec.}$

(*2) $t=5\ \text{Sec}$



Tilt Sensor Switch

Item No.	RBS320103	Description	Photoelectric	Version	13
Page	4 of 9		Publish Date	Jun. 22, 2018	

● Electrical Optical Characteristics (Ta=25°C)

Parameter	Symbol	Condition	Min.	Typ.	Max.	Unit
Forward Voltage	V _F	I _F =20mA	-	1.2	1.5	V
Reverse Current	I _R	V _R =5V	-	-	10	μA
Peak Wavelength	λ _p	I _F =10mA		940		nm
Dark Current	I _{ceo}	V _{CE} =10V	-	-	100	μA
C-E Saturation Voltage	V _{CE (sat)}	I _C =0.25mA I _F =20mA	-	-	0.4	V
Light Current	I _c	V _{CE} =5V I _F =20mA	0.5	5	-	mA
Rise Time	T _r	I _C =0.8mA V _{CC} =30V	-	5	-	μsec
Fall Time	T _f	R _L =1KΩ	-	5	-	μsec
Operation Diagram	θ	Fig. 1	20	30	40	°



Tilt Sensor Switch

Item No.	RBS320103	Description	Photoelectric	Version	13
Page	5 of 9		Publish Date	Jun. 22, 2018	

● Typical Electrical / Optical Characteristics Curves (Ta=25°C)

Fig.1 Power Dissipation vs. Ambient Temperature

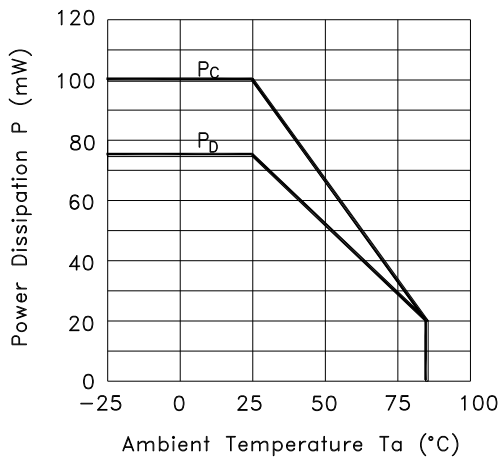

Fig.2 Forward Current vs. Forward Voltage

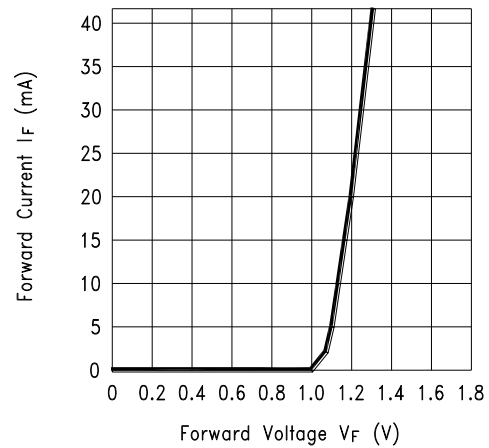

Fig.3 Collector Current vs. Collector-emitter Voltage

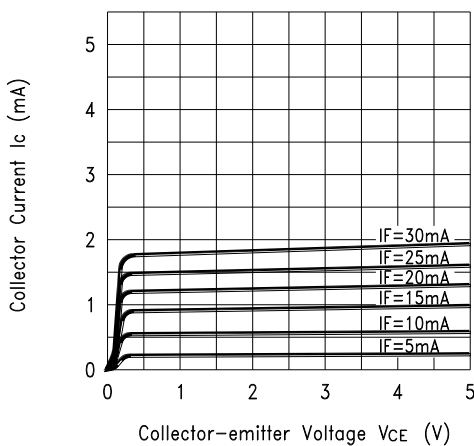
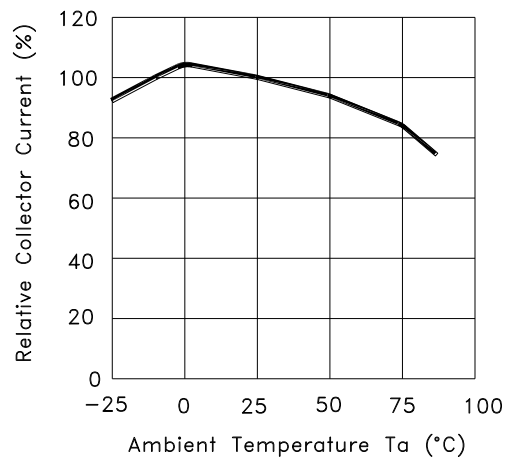

Fig.4 Collector Current vs. Ambient Temperature



Tilt Sensor Switch

Item No.	RBS320103	Description	Photoelectric	Version	13
Page	6 of 9		Publish Date	Jun. 22, 2018	

Fig.5 Collector-emitter Saturation Voltage vs. Ambient Temperature

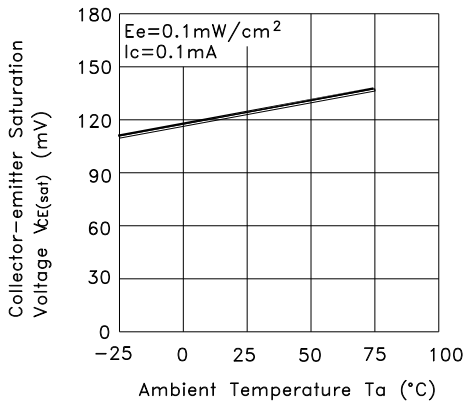

Fig.6 Response Time vs. Load Resistance

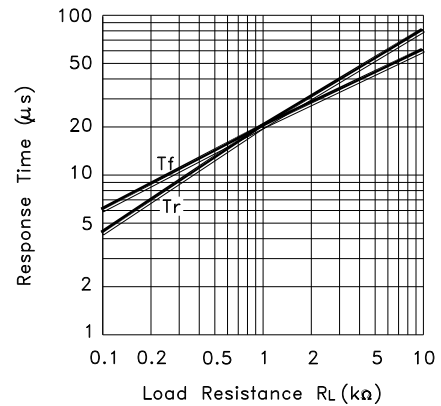
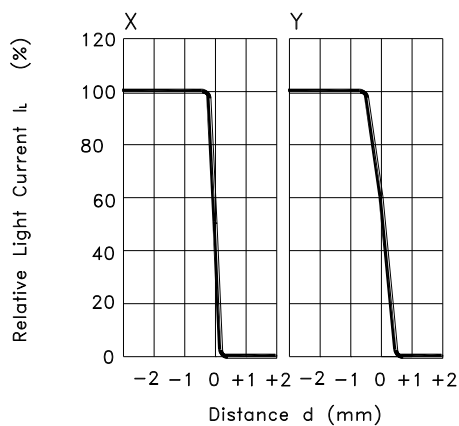
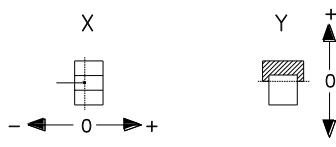
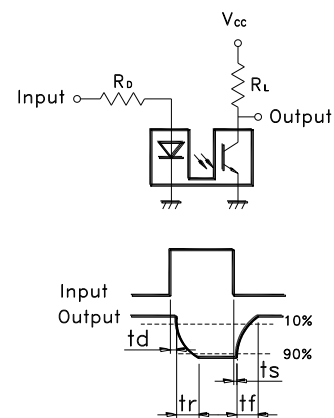

Fig.7 Sensing Position Characteristics (Typical)



Test Circuit for Response Time



Tilt Sensor Switch

Item No.	RBS320103	Description	Photoelectric	Version	13
Page	7 of 9		Publish Date	Jun. 22, 2018	

● RELIABLE TEST ITEMS

Reliable Test for RBS320203

	Test Item	Contents
1	Operating Temperature	-25°C ~ 85°C
2	Storage Temperature	-40°C ~ 85°C
3	Humidity	40 °C / 95 %RH
4	Mechanical Life	2Hz, horizontal 1,000,000 times
5	Electrical Life	I _F =20 mA, V _{CE} =5 V TIME: 30,000 hrs

● SOLDERING CONDITION

Following soldering conditions are for reference only, please use soldering information that solder paste manufacturer recommends.

Condition	Soldering Temperature	Soldering Time	Wattage of Manual Soldering	Type
Suitable Production Process				
Wave Soldering	260±5°C	< 5 seconds max.	-	DIP
Manual Soldering	300±5°C	< 3 seconds max.	20W or Temperature-controlled manual soldering	DIP



Tilt Sensor Switch

Item No.	RBS320103	Description	Photoelectric	Version	13
Page	8 of 9		Publish Date	Jun. 22, 2018	

● PACKAGE

	Part Number	Package	Quantity	Total	Dimension (mm)
1.	RBS320103	IC tube	62 pcs	62 pcs	525L*10W*17.5H
		Inner box	120 tubes	7,440 pcs	539L*130W*130H
		Outer carton	4 boxes	29,760 pcs	551L*285W*288H

※ Package shown as below for reference.



Tilt Sensor Switch

Item No.	RBS320103	Description	Photoelectric	Version	13
Page	9 of 9		Publish Date	Jun. 22, 2018	

● NOTES

1. Suggestion for usage: For vibration usage or application, we suggest to add hysteresis for IC.
2. For the continued product improvement as one of the company policy, specifications may change or update without notice. The latest information can be obtained through our sales offices. Normally, all products are supplied under our standard conditions.

● PRECAUTIONS FOR USE

1. If the products is intended to be used for other endurance equipment requiring higher safety and reliability such as life support system, space and aviation devices, disaster and safety system, it's necessary to make verification of conformity or contact us for the details before using.
2. Do not try to clean the switch with a solvent or similar substance after the soldering process.
3. Use water-soluble flux may damage the switch.
4. Please follow the soldering instruction accordingly, otherwise might lead to defective.
5. Do not use switch in the environment of high humidity, because such an environment may cause the leakage current between the terminals.
6. Please do not exceed the rated load as there will be a risk of disabling the product function.
7. In the circuit, switch should not be near or directly connected with the magnetic component solder joints (for example: relays, transformers, etc.).
8. To prevent damaging IR and PT, please make electrostatic protective treatment, for example: wearing a conductive wrist strap or antistatic gloves during production process, grounding machinery etc.

