

Tilt Sensor Switch

Item No.	RBS360102	Description	Photoelectric	Version	6
Page	1 of 10		Publish Date	Aug. 06, 2020	

● **FUNCTIONS**

1. Tilt Angles: 20° within a 360° radius
2. Suitable to horizontal PCB
3. Vibration Detecting

● **APPLICATIONS**

1. Automatically shut off for home appliances
2. Automatically shut off for Sporting equipment
3. Alarm system
4. Anti-theft / Anti-tamper devices
5. Being motion detection
6. Wake up systems for power saving
7. Automatically shut off for motorbike
8. Earthquake Detecting

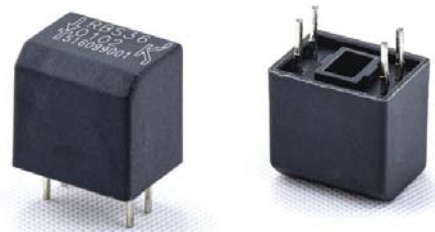

● **FEATURES**

1. Housing made of high insulation plastic material, free from electric conduction and rust problem.
2. Sensing by phototransistors, Generating highly reliable and stable signals, not affected by oxidation or wear of metal.
3. All plastic materials subject to industrial purpose. Resist high temperature.
4. Simple ON and OFF signals, easy for design.
5. RoHS compliance, an ideal substitute for mercury switch.
6. A more economical tilt and vibration detection option than IC design solution.
7. All made in Taiwan and examined before shipment.



Tilt Sensor Switch

Item No.	RBS360102	Description	Photoelectric	Version	6
Page	2 of 10		Publish Date	Aug. 06, 2020	

● PATENTS

1. Taiwan Patent No. M 420033
2. Taiwan Patent No. M 450817
3. Taiwan Patent No. I 451463
4. Taiwan Patent No. I 553684
5. China Patent No. ZL 201120339658.7
6. China Patent No. ZL 201220539712.7
7. China Patent No. ZL201210017866.4
8. China Patent No. ZL201210402905.2
9. U.S.A. Patent No. US 8,927,919,B2
10. U.S.A. Patent No. US 9,154,129 B2



Tilt Sensor Switch

Item No.	RBS360102	Description	Photoelectric	Version	6
Page	3 of 10		Publish Date	Aug. 06, 2020	

● DIMENSIONS / OPERATION / P.C.B. LAYOUT (Unit: mm, Tolerance: ±0.25mm)

Fig. 1

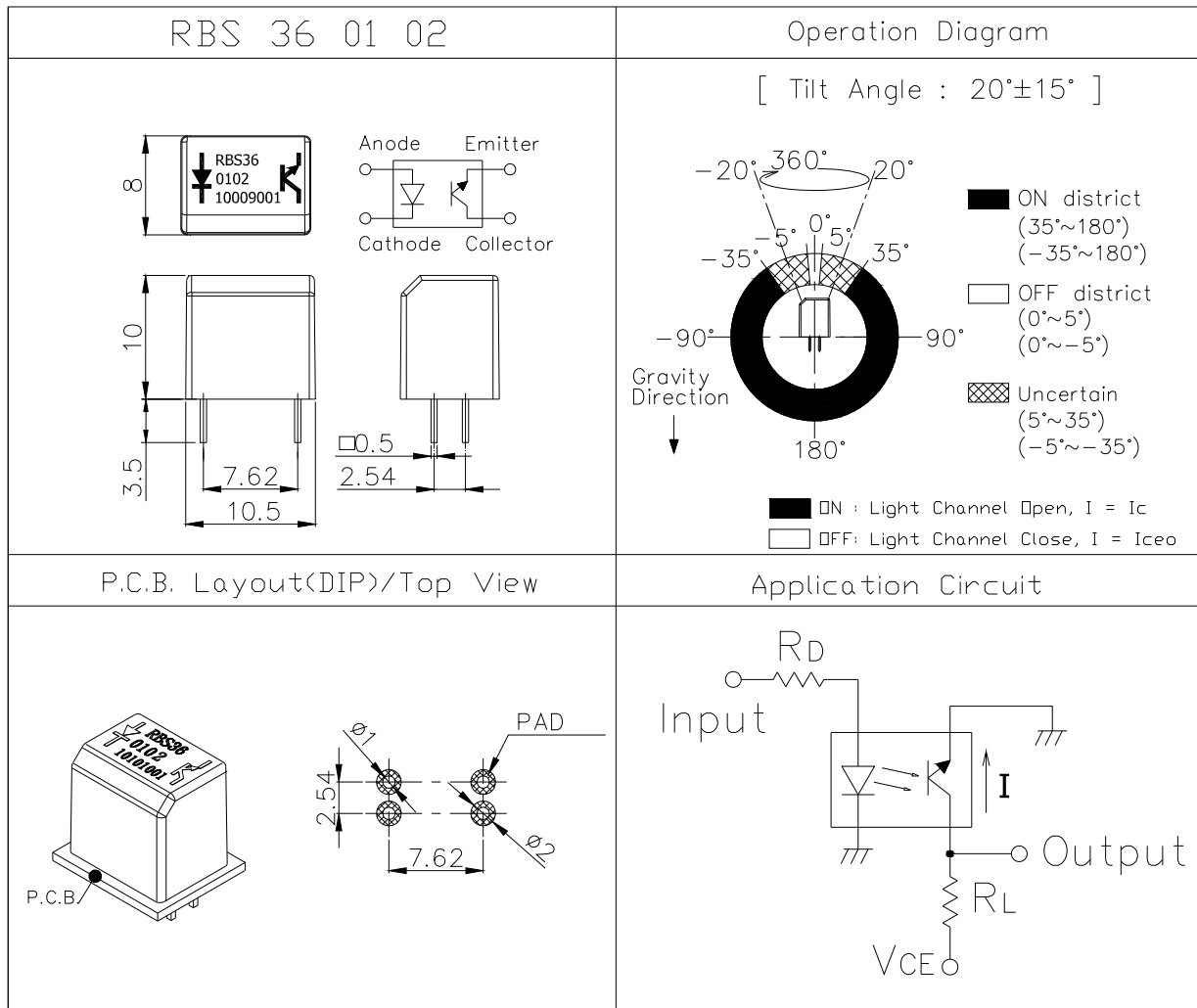

Tilt Sensor Switch

Item No.	RBS360102	Description	Photoelectric	Version	6
Page	4 of 10		Publish Date	Aug. 06, 2020	

● Current/Voltage Suggested

Input Current	Operating Voltage	Condition
10 mA	3.3 V	V _{CE} =3.3V R _D =200 ohm R _L =68K ohm
10 mA	5 V	V _{CE} =5V R _D =390 ohm R _L =100K ohm

* Please refer to above Application Circuit for designing electrical circuit.

● Absolute Maximum Rating (Ta=25°C)

Item		Symbol	Rating	Unit
Input	Power Dissipation	P _d	75	mW
	Reverse Voltage	V _R	5	V
	Forward Current	I _F	50	mA
	Peak Forward Current	I _{FP}	1	A
Output	Collector Power Dissipation	P _C	100	mW
	Collector Current	I _C	20	mA
	C-E Voltage	V _{CEO}	30	V
	E-C Voltage	V _{ECO}	5	V
Operating Temperature		T _{opr}	-25 ~ +85	°C
Storage Temperature		T _{stg}	-40 ~ +85	°C
Soldering Temperature (*1)		T _{sol}	260	°C

(*1) t=5 Sec



Tilt Sensor Switch

Item No.	RBS360102	Description	Photoelectric	Version	6
Page	5 of 10		Publish Date	Aug. 06, 2020	

● Electrical Optical Characteristics (Ta=25°C)

Parameter	Symbol	Condition	Min.	Typ.	Max.	Unit
Forward Voltage	V_F	$I_F=20mA$	-	1.2	1.5	V
Reverse Current	I_R	$V_R=5V$	-	-	10	μA
Peak Wavelength	λ_p	$I_F=10mA$		940		nm
Dark Current	I_{ceo}	$V_{CE}=10V$	-	-	20	μA
C-E Saturation Voltage	$V_{CE(sat)}$	$I_C=0.25mA$ $I_F=20mA$	-	-	0.4	V
Light Current	I_C	$V_{CE}=5V$ $I_F=20mA$	0.1	5	-	mA
Rise Time	T_r	$I_C=0.8mA$ $V_{CC}=30V$	-	5	-	μsec
Fall Time	T_f	$R_L=1K\Omega$	-	5	-	μsec
Operation Diagram	θ	Fig. 1	5	20	35	$^\circ$



Tilt Sensor Switch

Item No.	RBS360102	Description	Photoelectric	Version	6
Page	6 of 10		Publish Date	Aug. 06, 2020	

● Typical Electrical / Optical Characteristics Curves (Ta=25°C)

Fig.1 Power Dissipation vs. Ambient Temperature

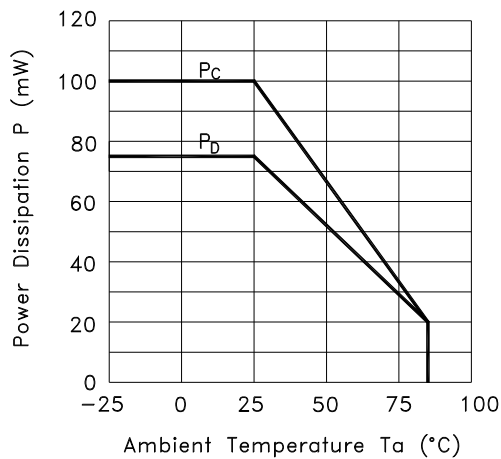

Fig.2 Forward Current vs. Forward Voltage

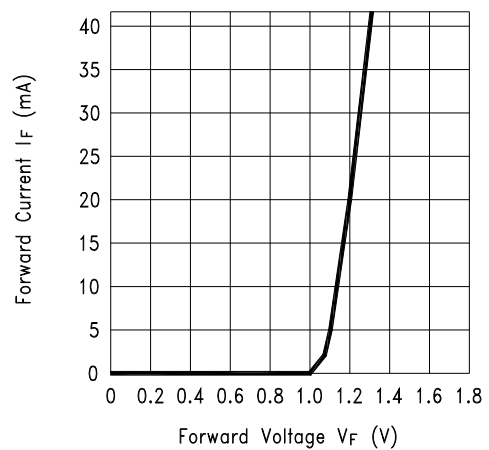

Fig.3 Collector Current vs. Collector-emitter Voltage

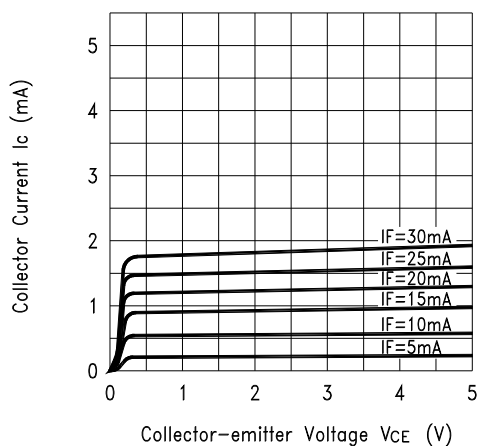
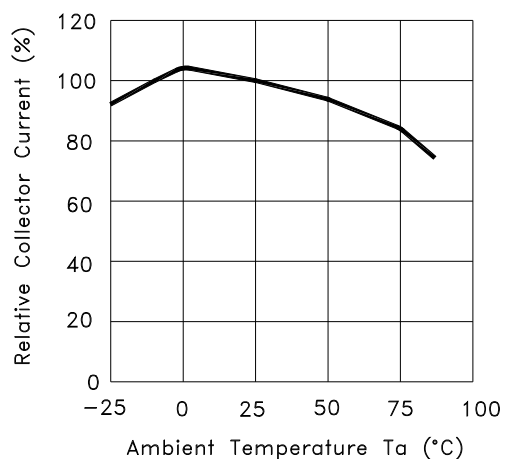

Fig.4 Collector Current vs. Ambient Temperature



Tilt Sensor Switch

Item No.	RBS360102	Description	Photoelectric	Version	6
Page	7 of 10		Publish Date	Aug. 06, 2020	

Fig.5 Collector-emitter Saturation Voltage vs. Ambient Temperature

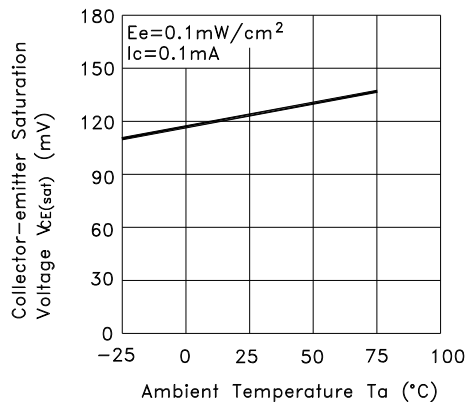

Fig.6 Response Time vs. Load Resistance

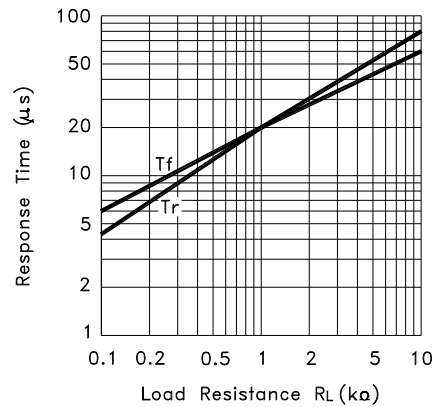
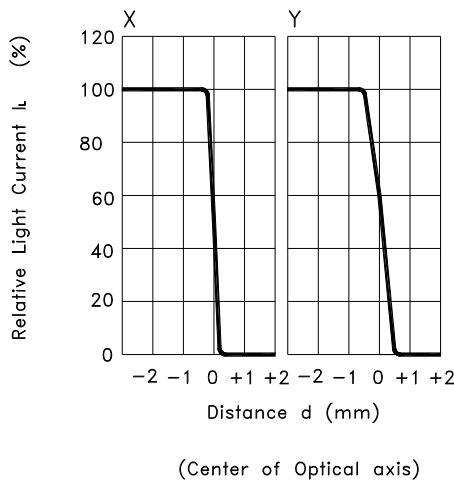
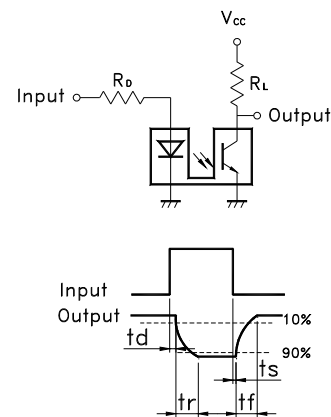

Fig.7 Sensing Position Characteristics (Typical)



Test Circuit for Response Time



Tilt Sensor Switch

Item No.	RBS360102	Description	Photoelectric	Version	6
Page	8 of 10		Publish Date	Aug. 06, 2020	

● RELIABILITY TEST

Reliable Test for RBS360102

	Test Item	Contents
1	Operating Temp	-25°C ~ 85°C
2	Storage Temp	-40°C ~ 85°C
3	Humidity Test	40°C / 95 %RH
4	Mechanical Test	2Hz, horizontal 1,000,000 times
5	Operation Life Test	I _F =20 mA, V _{CE} =5 V TIME: 30,000 hrs

● SOLDERING CONDITION

Following soldering conditions are for reference only, please use soldering information that solder paste manufacturer recommends.

Condition	Soldering Temperature	Soldering Time	Wattage of Manual Soldering	Type
Wave Soldering	260±5°C	< 5 seconds max.	-	DIP
Manual Soldering	300±5°C	< 3 seconds max.	20W or Temperature-controlled manual soldering	DIP



Tilt Sensor Switch

Item No.	RBS360102	Description	Photoelectric	Version	6
Page	9 of 10		Publish Date	Aug. 06, 2020	

● PACKAGE

	Part Number	Package	Quantity	Total	Dimension (mm)
1.	RBS360102	IC Tube	48 pcs	48 pcs	525L*10W*17.5H
		Inner box	84 Tubes	4,032 pcs	539L*130W*130H
		Carton	4 Boxes	16,128 pcs	551L*285W*288H

※ Package is shown as below for reference !



Tilt Sensor Switch

Item No.	RBS360102	Description	Photoelectric	Version	6
Page	10 of 10		Publish Date	Aug. 06, 2020	

● NOTE

1. Suggestion for usage: For vibration usage or application, we suggest to add hysteresis for IC.
2. For the continued product improvement as one of the company policy, specifications may change or update without notice. The latest information can be obtained through our sales offices. Normally, all products are supplied under our standard conditions.

● PRECAUTIONS FOR USE

1. If the products is intended to be used for other endurance equipment requiring higher safety and reliability such as life support system, space and aviation devices, disaster and safety system, it's necessary to make verification of conformity or contact us for the details before using.
2. Do not try to clean the switch with a solvent or similar substance after the soldering process.
3. Use water-soluble flux may damage the switch.
4. Please follow the soldering instruction accordingly, otherwise might lead to defective.
5. Do not use switch in the environment of high humidity, because such an environment may cause the leakage current between the terminals.
6. Please do not exceed the rated load as there will be a risk of disabling the product function.
7. In the circuit, switch should not be near or directly connected with the magnetic component solder joints (for example: relays, transformers, etc.).
8. To prevent damaging IR and PT, please make ESD protection, for example: wearing a conductive wrist strap or antistatic gloves during production process, or grounding machinery etc.

