

# XLamp® MHB-A LEDs



## PRODUCT DESCRIPTION

The XLamp® MHB-A LED is a new generation of high-power LED that delivers a more effective way to achieve low-cost systems than mid-power (MP) LEDs. Built using Cree LED's high-reliability ceramic-package technology, the XLamp MHB-A LED is able to operate at higher temperatures than MP LEDs with no reduction in rated lifetime, enabling an impressive 60% reduction in heat sink size and cost. Using up to 26 times fewer LEDs than MP LEDs to achieve the same performance, the XLamp MHB-A LED is optimized to simplify LED system designs for directional and semi-directional applications.

## FEATURES

- Flexible 9-V, 18-V or 36-V options
- Maximum drive current: 700 mA (9 V), 350 mA (18 V), 175 mA (36 V)
- Viewing angle: 115°
- Available in 70-CRI, 80-CRI and 90-CRI options
- Unlimited floor life at ≤ 30 °C/85% RH
- Reflow solderable - JEDEC J-STD-020C
- Electrically neutral thermal path
- RoHS and REACH compliant
- UL® recognized component (E349212)

## TABLE OF CONTENTS

Characteristics .....	2
Flux Characteristics, EasyWhite® Order Codes and Bins - 9 V .....	3
Flux Characteristics, EasyWhite® Order Codes and Bins - 18 V .....	6
Flux Characteristics, EasyWhite® Order Codes and Bins - 36 V .....	9
Relative Spectral Power Distribution .....	12
Relative Flux vs. Junction Temperature.....	12
Electrical Characteristics.....	13
Relative Flux vs. Current .....	14
Relative Chromaticity vs. Current.....	16
Relative Chromaticity vs. Temperature.....	17
Typical Spatial Distribution.....	17
Thermal Design .....	18
Performance Groups – Luminous Flux.....	19
Performance Groups – Chromaticity.....	20
Standard White Chromaticity Regions Plotted on the 1931 CIE Curve .....	21
Bin and Order Code Formats .....	22
Reflow Soldering Characteristics.....	23
Notes .....	24
Mechanical Dimensions .....	26
Tape and Reel.....	28
Packaging.....	30



Cree LED / 4001 E. Hwy. 54, Suite 2000 / Durham, NC 27709 USA / +1.919.313.5330 / [www.cree-led.com](http://www.cree-led.com)

## CHARACTERISTICS

Characteristics	Unit	Minimum	Typical	Maximum
Thermal resistance, junction to solder point <sup>o</sup>	°C/W		2.9	
Viewing angle (FWHM)	degrees		115	
Temperature coefficient of voltage (9 V)	mV/°C		-4	
Temperature coefficient of voltage (18 V)	mV/°C		-8	
Temperature coefficient of voltage (36 V)	mV/°C		-16	
ESD withstand voltage (HBM per Mil-Std-883D)			Class 3B	
DC forward current (9 V)	mA		480	700
DC forward current (18 V)	mA		240	350
DC forward current (36 V)	mA		120	175
Reverse current (9 V, 18 V, 36 V)	mA			0.1
Forward voltage (9 V, @ 480 mA, 85 °C)	V		9.25	
Forward voltage (9 V, @ 480 mA, 25 °C)	V			10.5
Forward voltage (18 V, @ 240 mA, 85 °C)	V		18.5	
Forward voltage (18 V, @ 240 mA, 25 °C)	V			21
Forward voltage (36 V, @ 120 mA, 85 °C)	V		37	
Forward voltage (36 V, @ 120 mA, 25 °C)	V			42
LED junction temperature	°C			150

## Note:

- ◇ Thermal resistance measurement was performed per the JEDEC JESD51-14 standard. See the [Thermal Resistance Measurement application note](#) for more details.

**FLUX CHARACTERISTICS, EASYWHITE® ORDER CODES AND BINS - 9 V**

The following table provides order codes for XLamp MHB-A LEDs. For a complete description of the order code nomenclature, please see the Bin and Order Code Formats section (page 22).

Test condition:  $T_J = 85\text{ }^\circ\text{C}$ , 9 V,  $I_F = 480\text{ mA}$

Nominal CCT	CRI	Minimum Luminous Flux @ 480 mA			2-Step		3-Step		5-Step	
		Min	Group	Flux (lm) @ 85 °C	Flux (lm) @ 25 °C*	Group	Order Code	Group	Order Code	Group
6500 K	70	D2	510	570					65E	MHBAWT-0000-000C0BD265E
		D4	550	615						MHBAWT-0000-000C0BD465E
		E2	590	660						MHBAWT-0000-000C0BE265E
	80	C4	475	531					65E	MHBAWT-0000-000C0HC465E
		D2	510	570						MHBAWT-0000-000C0HD265E
		D4	550	615						MHBAWT-0000-000C0HD465E
	90	B4	410	459					65E	MHBAWT-0000-000C0UB465E
		C2	440	492						MHBAWT-0000-000C0UC265E
		C4	475	531						MHBAWT-0000-000C0UC465E
5700 K	70	D2	510	570					57E	MHBAWT-0000-000C0BD257E
		D4	550	615						MHBAWT-0000-000C0BD457E
		E2	590	660						MHBAWT-0000-000C0BE257E
	80	C4	475	531					57E	MHBAWT-0000-000C0HC457E
		D2	510	570						MHBAWT-0000-000C0HD257E
		D4	550	615						MHBAWT-0000-000C0HD457E
	90	B4	410	459					57E	MHBAWT-0000-000C0UB457E
		C2	440	492						MHBAWT-0000-000C0UC257E
		C4	475	531						MHBAWT-0000-000C0UC457E

**Notes**

- Cree LED maintains a tolerance of ±7% on flux and power measurements, ±0.005 on chromaticity (CCx, CCy) measurements and a tolerance of ±2 on CRI measurements. See the Measurements section (page 24).
- MHB-A LED order codes specify only a minimum flux bin and not a maximum. Cree LED may ship reels in flux bins higher than the minimum specified by the order code without advance notice. Shipments will always adhere to the chromaticity bin restrictions specified by the order code.
- \* Flux values @ 25 °C are calculated and for reference only.

FLUX CHARACTERISTICS, EASYWHITE® ORDER CODES AND BINS - 9 V - CONTINUED

Nominal CCT	CRI	Minimum Luminous Flux @ 480 mA			2-Step		3-Step		5-Step	
		Min	Group	Flux (lm) @ 85 °C	Flux (lm) @ 25 °C*	Group	Order Code	Group	Order Code	Group
5000 K	70	D2	510	570					50E	MHBAWT-0000-000C0BD250E
		D4	550	615						MHBAWT-0000-000C0BD450E
		E2	590	660						MHBAWT-0000-000C0BE250E
	80	C4	475	531			50G	MHBAWT-0000-000C0HC450G	50E	MHBAWT-0000-000C0HC450E
		D2	510	570				MHBAWT-0000-000C0HD250G		MHBAWT-0000-000C0HD250E
		D4	550	615				MHBAWT-0000-000C0HD450G		MHBAWT-0000-000C0HD450E
	90	B4	410	459			50G	MHBAWT-0000-000C0UB450G	50E	MHBAWT-0000-000C0UB450E
		C2	440	492				MHBAWT-0000-000C0UC250G		MHBAWT-0000-000C0UC250E
		C4	475	531				MHBAWT-0000-000C0UC450G		MHBAWT-0000-000C0UC450E
4000 K	70	C4	475	531					40E	MHBAWT-0000-000C0BC440E
		D2	510	570						MHBAWT-0000-000C0BD240E
		D4	550	615						MHBAWT-0000-000C0BD440E
		E2	590	660						MHBAWT-0000-000C0BE240E
	80	C4	475	531		MHBAWT-0000-000C0HC440H	40G	MHBAWT-0000-000C0HC440G		
		D2	510	570	40H	MHBAWT-0000-000C0HD240H		MHBAWT-0000-000C0HD240G		
	90	B2	380	425		MHBAWT-0000-000C0UB240H	40G	MHBAWT-0000-000C0UB240G		
		B4	410	459	40H	MHBAWT-0000-000C0UB440H		MHBAWT-0000-000C0UB440G		
		C2	440	492		MHBAWT-0000-000C0UC240H		MHBAWT-0000-000C0UC240G		

Notes

- Cree LED maintains a tolerance of ±7% on flux and power measurements, ±0.005 on chromaticity (CCx, CCy) measurements and a tolerance of ±2 on CRI measurements. See the Measurements section (page 24).
- MHB-A LED order codes specify only a minimum flux bin and not a maximum. Cree LED may ship reels in flux bins higher than the minimum specified by the order code without advance notice. Shipments will always adhere to the chromaticity bin restrictions specified by the order code.
- \* Flux values @ 25 °C are calculated and for reference only.

FLUX CHARACTERISTICS, EASYWHITE® ORDER CODES AND BINS - 9 V - CONTINUED

Nominal CCT	CRI	Minimum Luminous Flux @ 480 mA			2-Step		3-Step		5-Step		
		Min	Group	Flux (lm) @ 85 °C	Flux (lm) @ 25 °C*	Group	Order Code	Group	Order Code	Group	Order Code
3500 K	80	C4	475	531	35H	MHBAWT-0000-000C0HC435H	35G	MHBAWT-0000-000C0HC435G			
		D2	510	570		MHBAWT-0000-000C0HD235H		MHBAWT-0000-000C0HD235G			
	90	A2	330	369	35H	MHBAWT-0000-000C0UA235H	35G	MHBAWT-0000-000C0UA235G			
		A4	355	397		MHBAWT-0000-000C0UA435H		MHBAWT-0000-000C0UA435G			
		B2	380	425		MHBAWT-0000-000C0UB235H		MHBAWT-0000-000C0UB235G			
		B4	410	459		MHBAWT-0000-000C0UB435H		MHBAWT-0000-000C0UB435G			
	3000 K	80	C2	440	492	30H	MHBAWT-0000-000C0HC230H	30G	MHBAWT-0000-000C0HC230G		
			C4	475	531		MHBAWT-0000-000C0HC430H		MHBAWT-0000-000C0HC430G		
D2			510	570	MHBAWT-0000-000C0HD230H		MHBAWT-0000-000C0HD230G				
90		A2	330	369	30H	MHBAWT-0000-000C0UA230H	30G	MHBAWT-0000-000C0UA230G			
		A4	355	397		MHBAWT-0000-000C0UA430H		MHBAWT-0000-000C0UA430G			
		B2	380	425		MHBAWT-0000-000C0UB230H		MHBAWT-0000-000C0UB230G			
		B4	410	459		MHBAWT-0000-000C0UB430H		MHBAWT-0000-000C0UB430G			
2700 K		80	C2	440	492	27H	MHBAWT-0000-000C0HC227H	27G	MHBAWT-0000-000C0HC227G		
	C4		475	531	MHBAWT-0000-000C0HC427H		MHBAWT-0000-000C0HC427G				
	90	A2	330	369	27H	MHBAWT-0000-000C0UA227H	27G	MHBAWT-0000-000C0UA227G			
		A4	355	397		MHBAWT-0000-000C0UA427H		MHBAWT-0000-000C0UA427G			
		B2	380	425		MHBAWT-0000-000C0UB227H		MHBAWT-0000-000C0UB227G			
		B4	410	459		MHBAWT-0000-000C0UB427H		MHBAWT-0000-000C0UB427G			

Notes

- Cree LED maintains a tolerance of ±7% on flux and power measurements, ±0.005 on chromaticity (CCx, CCy) measurements and a tolerance of ±2 on CRI measurements. See the Measurements section (page 24).
- MHB-A LED order codes specify only a minimum flux bin and not a maximum. Cree LED may ship reels in flux bins higher than the minimum specified by the order code without advance notice. Shipments will always adhere to the chromaticity bin restrictions specified by the order code.
- \* Flux values @ 25 °C are calculated and for reference only.

**FLUX CHARACTERISTICS, EASYWHITE® ORDER CODES AND BINS - 18 V**

The following table provides order codes for XLamp MHB-A LEDs. For a complete description of the order code nomenclature, please see the Bin and Order Code Formats section (page 22).

Test condition:  $T_J = 85\text{ °C}$ ,  $18\text{ V}$ ,  $I_F = 240\text{ mA}$

Nominal CCT	CRI	Minimum Luminous Flux @ 240 mA			2-Step		3-Step		5-Step	
		Min	Group	Flux (lm) @ 85 °C	Flux (lm) @ 25 °C*	Group	Order Code	Group	Order Code	Group
6500 K	70	D2	510	570					65E	MHBAWT-0000-000F0BD265E
		D4	550	615						MHBAWT-0000-000F0BD465E
		E2	590	660						MHBAWT-0000-000F0BE265E
	80	C4	475	531					65E	MHBAWT-0000-000F0HC465E
		D2	510	570						MHBAWT-0000-000F0HD265E
		D4	550	615						MHBAWT-0000-000F0HD465E
	90	B4	410	459					65E	MHBAWT-0000-000F0UB465E
		C2	440	492						MHBAWT-0000-000F0UC265E
		C4	475	531						MHBAWT-0000-000F0UC465E
5700 K	70	D2	510	570					57E	MHBAWT-0000-000F0BD257E
		D4	550	615						MHBAWT-0000-000F0BD457E
		E2	590	660						MHBAWT-0000-000F0BE257E
	80	C4	475	531					57E	MHBAWT-0000-000F0HC457E
		D2	510	570						MHBAWT-0000-000F0HD257E
		D4	550	615						MHBAWT-0000-000F0HD457E
	90	B4	410	459					57E	MHBAWT-0000-000F0UB457E
		C2	440	492						MHBAWT-0000-000F0UC257E
		C4	475	531						MHBAWT-0000-000F0UC457E

**Notes**

- Cree LED maintains a tolerance of ±7% on flux and power measurements, ±0.005 on chromaticity (CCx, CCy) measurements and a tolerance of ±2 on CRI measurements. See the Measurements section (page 24).
- MHB-A LED order codes specify only a minimum flux bin and not a maximum. Cree LED may ship reels in flux bins higher than the minimum specified by the order code without advance notice. Shipments will always adhere to the chromaticity bin restrictions specified by the order code.
- \* Flux values @ 25 °C are calculated and for reference only.

FLUX CHARACTERISTICS, EASYWHITE® ORDER CODES AND BINS - 18 V - CONTINUED

Nominal CCT	CRI	Minimum Luminous Flux @ 240 mA			2-Step		3-Step		5-Step	
		Min	Group	Flux (lm) @ 85 °C	Flux (lm) @ 25 °C*	Group	Order Code	Group	Order Code	Group
5000 K	70	D2	510	570					50E	MHBAWT-0000-000F0BD250E
		D4	550	615						MHBAWT-0000-000F0BD450E
		E2	590	660						MHBAWT-0000-000F0BE250E
	80	C4	475	531			50G	MHBAWT-0000-000F0HC450G	50E	MHBAWT-0000-000F0HC450E
		D2	510	570				MHBAWT-0000-000F0HD250G		MHBAWT-0000-000F0HD250E
		D4	550	615				MHBAWT-0000-000F0HD450G		MHBAWT-0000-000F0HD450E
	90	B4	410	459			50G	MHBAWT-0000-000F0UB450G	50E	MHBAWT-0000-000F0UB450E
		C2	440	492				MHBAWT-0000-000F0UC250G		MHBAWT-0000-000F0UC250E
		C4	475	531				MHBAWT-0000-000F0UC450G		MHBAWT-0000-000F0UC450E
4000 K	70	C4	475	531					40E	MHBAWT-0000-000F0BC440E
		D2	510	570						MHBAWT-0000-000F0BD240E
		D4	550	615						MHBAWT-0000-000F0BD440E
		E2	590	660						MHBAWT-0000-000F0BE240E
	80	C4	475	531		MHBAWT-0000-000F0HC440H	40G	MHBAWT-0000-000F0HC440G		
		D2	510	570	40H	MHBAWT-0000-000F0HD240H		MHBAWT-0000-000F0HD240G		
	90	B2	380	425		MHBAWT-0000-000F0UB240H	40G	MHBAWT-0000-000F0UB240G		
		B4	410	459	40H	MHBAWT-0000-000F0UB440H		MHBAWT-0000-000F0UB440G		
		C2	440	492		MHBAWT-0000-000F0UC240H		MHBAWT-0000-000F0UC240G		

Notes

- Cree LED maintains a tolerance of ±7% on flux and power measurements, ±0.005 on chromaticity (CCx, CCy) measurements and a tolerance of ±2 on CRI measurements. See the Measurements section (page 24).
- MHB-A LED order codes specify only a minimum flux bin and not a maximum. Cree LED may ship reels in flux bins higher than the minimum specified by the order code without advance notice. Shipments will always adhere to the chromaticity bin restrictions specified by the order code.
- \* Flux values @ 25 °C are calculated and for reference only.

**FLUX CHARACTERISTICS, EASYWHITE® ORDER CODES AND BINS - 18 V - CONTINUED**

Nominal CCT	CRI	Minimum Luminous Flux @ 240 mA			2-Step		3-Step		5-Step	
		Min	Group	Flux (lm) @ 85 °C	Flux (lm) @ 25 °C*	Group	Order Code	Group	Order Code	Group
3500 K	80	C4	475	531	35H	MHBAWT-0000-000F0HC435H	35G	MHBAWT-0000-000F0HC435G		
		D2	510	570		MHBAWT-0000-000F0HD235H		MHBAWT-0000-000F0HD235G		
	90	A2	330	369	35H	MHBAWT-0000-000F0UA235H	35G	MHBAWT-0000-000F0UA235G		
		A4	355	397		MHBAWT-0000-000F0UA435H		MHBAWT-0000-000F0UA435G		
		B2	380	425		MHBAWT-0000-000F0UB235H		MHBAWT-0000-000F0UB235G		
		B4	410	459		MHBAWT-0000-000F0UB435H		MHBAWT-0000-000F0UB435G		
	3000 K	80	C2	440	492	30H	MHBAWT-0000-000F0HC230H	30G	MHBAWT-0000-000F0HC230G	
C4			475	531	MHBAWT-0000-000F0HC430H		MHBAWT-0000-000F0HC430G			
D2			510	570	MHBAWT-0000-000F0HD230H		MHBAWT-0000-000F0HD230G			
90		A2	330	369	30H	MHBAWT-0000-000F0UA230H	30G	MHBAWT-0000-000F0UA230G		
		A4	355	397		MHBAWT-0000-000F0UA430H		MHBAWT-0000-000F0UA430G		
		B2	380	425		MHBAWT-0000-000F0UB230H		MHBAWT-0000-000F0UB230G		
		B4	410	459		MHBAWT-0000-000F0UB430H		MHBAWT-0000-000F0UB430G		
2700 K	80	C2	440	492	27H	MHBAWT-0000-000F0HC227H	27G	MHBAWT-0000-000F0HC227G		
		C4	475	531		MHBAWT-0000-000F0HC427H		MHBAWT-0000-000F0HC427G		
	90	A2	330	369	27H	MHBAWT-0000-000F0UA227H	27G	MHBAWT-0000-000F0UA227G		
		A4	355	397		MHBAWT-0000-000F0UA427H		MHBAWT-0000-000F0UA427G		
		B2	380	425		MHBAWT-0000-000F0UB227H		MHBAWT-0000-000F0UB227G		
		B4	410	459		MHBAWT-0000-000F0UB427H		MHBAWT-0000-000F0UB427G		

**Notes**

- Cree LED maintains a tolerance of ±7% on flux and power measurements, ±0.005 on chromaticity (CCx, CCy) measurements and a tolerance of ±2 on CRI measurements. See the Measurements section (page 24).
- MHB-A LED order codes specify only a minimum flux bin and not a maximum. Cree LED may ship reels in flux bins higher than the minimum specified by the order code without advance notice. Shipments will always adhere to the chromaticity bin restrictions specified by the order code.
- \* Flux values @ 25 °C are calculated and for reference only.



**FLUX CHARACTERISTICS, EASYWHITE® ORDER CODES AND BINS - 36 V**

The following table provides order codes for XLamp MHB-A LEDs. For a complete description of the order code nomenclature, please see the Bin and Order Code Formats section (page 22).

Test condition:  $T_J = 85\text{ }^\circ\text{C}$ ,  $36\text{ V}$ ,  $I_F = 120\text{ mA}$

Nominal CCT	CRI	Minimum Luminous Flux @ 120 mA			2-Step		3-Step		5-Step	
		Min	Group	Flux (lm) @ 85 °C	Flux (lm) @ 25 °C*	Group	Order Code	Group	Order Code	Group
6500 K	70	D2	510	570					65E	MHBAWT-0000-000N0BD265E
		D4	550	615						MHBAWT-0000-000N0BD465E
		E2	590	660						MHBAWT-0000-000N0BE265E
	80	C4	475	531					65E	MHBAWT-0000-000N0HC465E
		D2	510	570						MHBAWT-0000-000N0HD265E
		D4	550	615						MHBAWT-0000-000N0HD465E
	90	B4	410	459					65E	MHBAWT-0000-000N0UB465E
		C2	440	492						MHBAWT-0000-000N0UC265E
		C4	475	531						MHBAWT-0000-000N0UC465E
5700 K	70	D2	510	570					57E	MHBAWT-0000-000N0BD257E
		D4	550	615						MHBAWT-0000-000N0BD457E
		E2	590	660						MHBAWT-0000-000N0BE257E
	80	C4	475	531					57E	MHBAWT-0000-000N0HC457E
		D2	510	570						MHBAWT-0000-000N0HD257E
		D4	550	615						MHBAWT-0000-000N0HD457E
	90	B4	410	459					57E	MHBAWT-0000-000N0UB457E
		C2	440	492						MHBAWT-0000-000N0UC257E
		C4	475	531						MHBAWT-0000-000N0UC457E

**Notes**

- Cree LED maintains a tolerance of ±7% on flux and power measurements, ±0.005 on chromaticity (CCx, CCy) measurements and a tolerance of ±2 on CRI measurements. See the Measurements section (page 24).
- MHB-A LED order codes specify only a minimum flux bin and not a maximum. Cree LED may ship reels in flux bins higher than the minimum specified by the order code without advance notice. Shipments will always adhere to the chromaticity bin restrictions specified by the order code.
- \* Flux values @ 25 °C are calculated and for reference only.

FLUX CHARACTERISTICS, EASYWHITE® ORDER CODES AND BINS - 36 V - CONTINUED

Nominal CCT	CRI	Minimum Luminous Flux @ 120 mA			2-Step		3-Step		5-Step	
		Min	Group	Flux (lm) @ 85 °C	Flux (lm) @ 25 °C*	Group	Order Code	Group	Order Code	Group
5000 K	70	D2	510	570					50E	MHBAWT-0000-000N0BD250E
		D4	550	615						MHBAWT-0000-000N0BD450E
		E2	590	660						MHBAWT-0000-000N0BE250E
	80	C4	475	531			50G	MHBAWT-0000-000N0HC450G	50E	MHBAWT-0000-000N0HC450E
		D2	510	570				MHBAWT-0000-000N0HD250G		MHBAWT-0000-000N0HD250E
		D4	550	615				MHBAWT-0000-000N0HD450G		MHBAWT-0000-000N0HD450E
	90	B4	410	459			50G	MHBAWT-0000-000N0UB450G	50E	MHBAWT-0000-000N0UB450E
		C2	440	492				MHBAWT-0000-000N0UC250G		MHBAWT-0000-000N0UC250E
		C4	475	531				MHBAWT-0000-000N0UC450G		MHBAWT-0000-000N0UC450E
4000 K	70	C4	475	531					40E	MHBAWT-0000-000N0BC440E
		D2	510	570						MHBAWT-0000-000N0BD240E
		D4	550	615						MHBAWT-0000-000N0BD440E
		E2	590	660						MHBAWT-0000-000N0BE240E
	80	C4	475	531		MHBAWT-0000-000N0HC440H	40G	MHBAWT-0000-000N0HC440G		
		D2	510	570	40H	MHBAWT-0000-000N0HD240H		MHBAWT-0000-000N0HD240G		
	90	B2	380	425		MHBAWT-0000-000N0UB240H	40G	MHBAWT-0000-000N0UB240G		
		B4	410	459	40H	MHBAWT-0000-000N0UB440H		MHBAWT-0000-000N0UB440G		
		C2	440	492		MHBAWT-0000-000N0UC240H		MHBAWT-0000-000N0UC240G		

Notes

- Cree LED maintains a tolerance of ±7% on flux and power measurements, ±0.005 on chromaticity (CCx, CCy) measurements and a tolerance of ±2 on CRI measurements. See the Measurements section (page 24).
- MHB-A LED order codes specify only a minimum flux bin and not a maximum. Cree LED may ship reels in flux bins higher than the minimum specified by the order code without advance notice. Shipments will always adhere to the chromaticity bin restrictions specified by the order code.
- \* Flux values @ 25 °C are calculated and for reference only.

FLUX CHARACTERISTICS, EASYWHITE® ORDER CODES AND BINS - 36 V - CONTINUED

Nominal CCT	CRI	Minimum Luminous Flux @ 120 mA			2-Step		3-Step		5-Step	
		Min	Group	Flux (lm) @ 85 °C	Flux (lm) @ 25 °C*	Group	Order Code	Group	Order Code	Group
3500 K	80	C4	475	531	35H	MHBAWT-0000-000N0HC435H	35G	MHBAWT-0000-000N0HC435G		
		D2	510	570		MHBAWT-0000-000N0HD235H		MHBAWT-0000-000N0HD235G		
	90	A2	330	369	35H	MHBAWT-0000-000N0UA235H	35G	MHBAWT-0000-000N0UA235G		
		A4	355	397		MHBAWT-0000-000N0UA435H		MHBAWT-0000-000N0UA435G		
		B2	380	425		MHBAWT-0000-000N0UB235H		MHBAWT-0000-000N0UB235G		
		B4	410	459		MHBAWT-0000-000N0UB435H		MHBAWT-0000-000N0UB435G		
	3000 K	80	C2	440	492	30H	MHBAWT-0000-000N0HC230H	30G	MHBAWT-0000-000N0HC230G	
C4			475	531	MHBAWT-0000-000N0HC430H		MHBAWT-0000-000N0HC430G			
D2			510	570	MHBAWT-0000-000N0HD230H		MHBAWT-0000-000N0HD230G			
90		A2	330	369	30H	MHBAWT-0000-000N0UA230H	30G	MHBAWT-0000-000N0UA230G		
		A4	355	397		MHBAWT-0000-000N0UA430H		MHBAWT-0000-000N0UA430G		
		B2	380	425		MHBAWT-0000-000N0UB230H		MHBAWT-0000-000N0UB230G		
		B4	410	459		MHBAWT-0000-000N0UB430H		MHBAWT-0000-000N0UB430G		
2700 K	80	C2	440	492	27H	MHBAWT-0000-000N0HC227H	27G	MHBAWT-0000-000N0HC227G		
		C4	475	531		MHBAWT-0000-000N0HC427H		MHBAWT-0000-000N0HC427G		
	90	A2	330	369	27H	MHBAWT-0000-000N0UA227H	27G	MHBAWT-0000-000N0UA227G		
		A4	355	397		MHBAWT-0000-000N0UA427H		MHBAWT-0000-000N0UA427G		
		B2	380	425		MHBAWT-0000-000N0UB227H		MHBAWT-0000-000N0UB227G		
		B4	410	459		MHBAWT-0000-000N0UB427H		MHBAWT-0000-000N0UB427G		

Notes

- Cree LED maintains a tolerance of ±7% on flux and power measurements, ±0.005 on chromaticity (CCx, CCy) measurements and a tolerance of ±2 on CRI measurements. See the Measurements section (page 24).
- MHB-A LED order codes specify only a minimum flux bin and not a maximum. Cree LED may ship reels in flux bins higher than the minimum specified by the order code without advance notice. Shipments will always adhere to the chromaticity bin restrictions specified by the order code.
- \* Flux values @ 25 °C are calculated and for reference only.

RELATIVE SPECTRAL POWER DISTRIBUTION

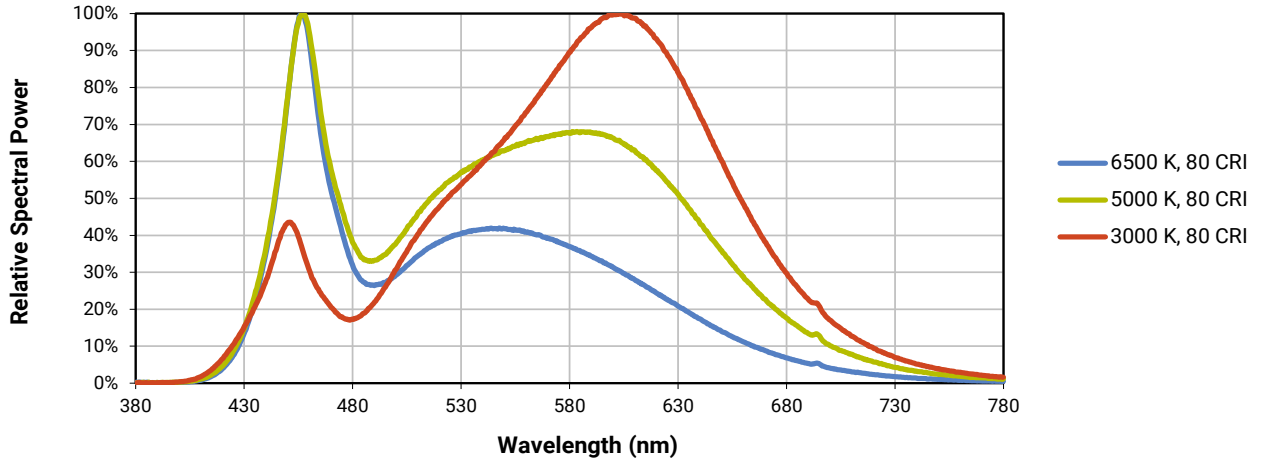

RELATIVE FLUX VS. JUNCTION TEMPERATURE

Test condition: 9 V,  $I_f = 480$  mA; 18 V,  $I_f = 240$  mA; 36 V,  $I_f = 120$  mA

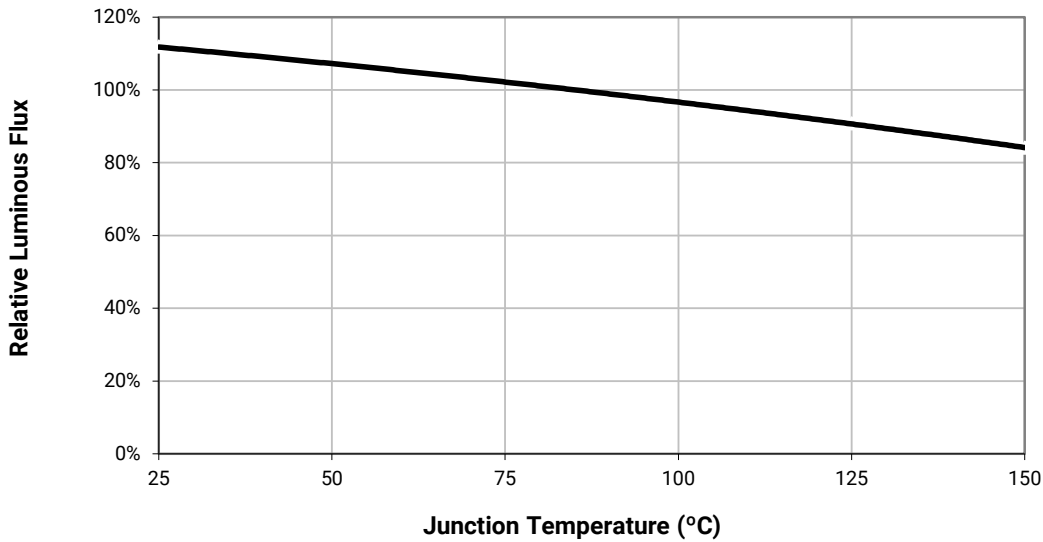

ELECTRICAL CHARACTERISTICS ( $T_j = 85\text{ }^\circ\text{C}$ )

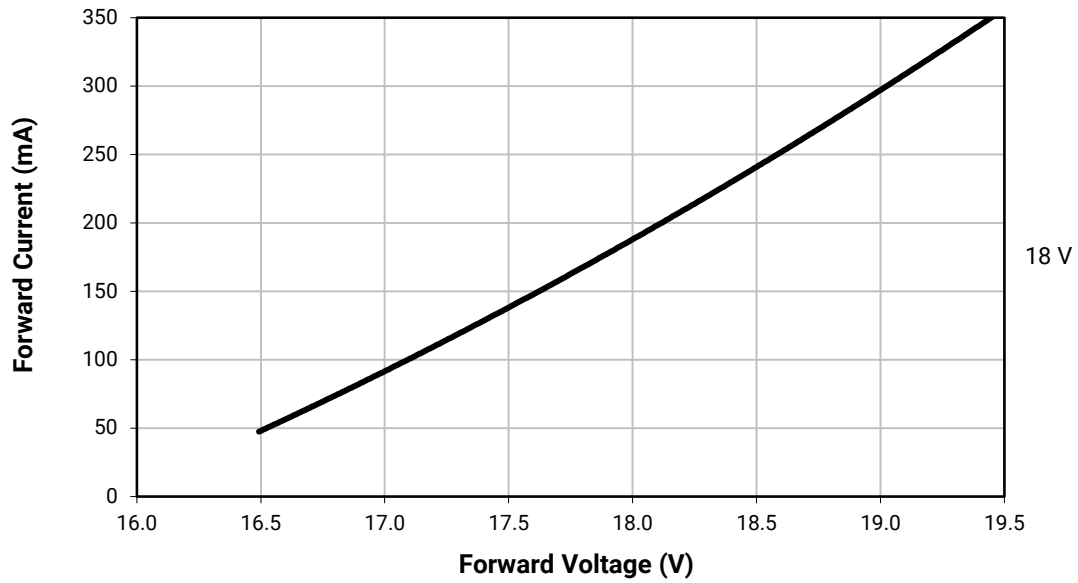
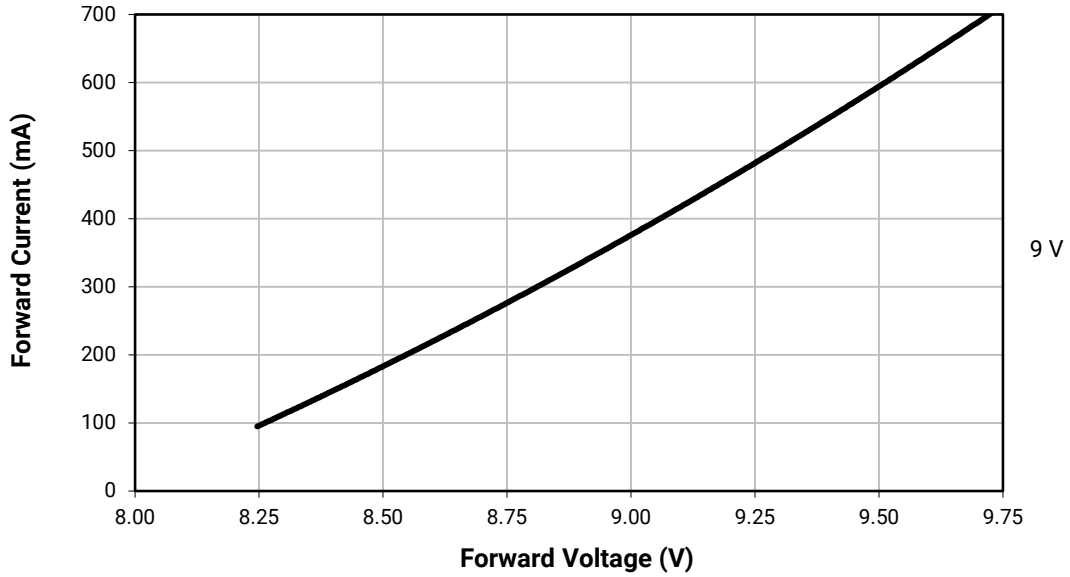

**ELECTRICAL CHARACTERISTICS ( $T_j = 85\text{ }^\circ\text{C}$ ) - CONTINUED**

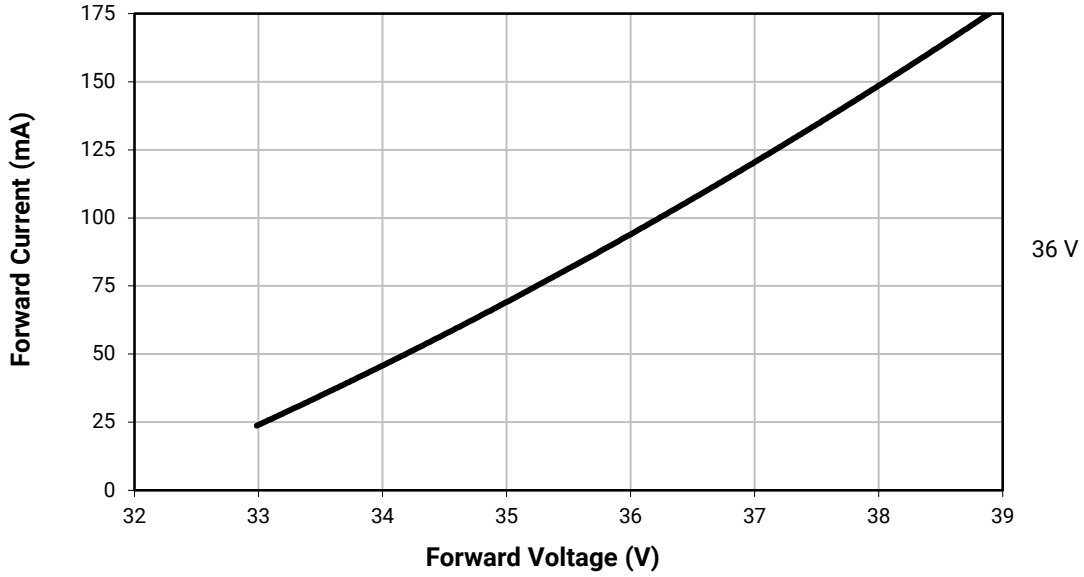

**RELATIVE FLUX VS. CURRENT ( $T_j = 85\text{ }^\circ\text{C}$ )**

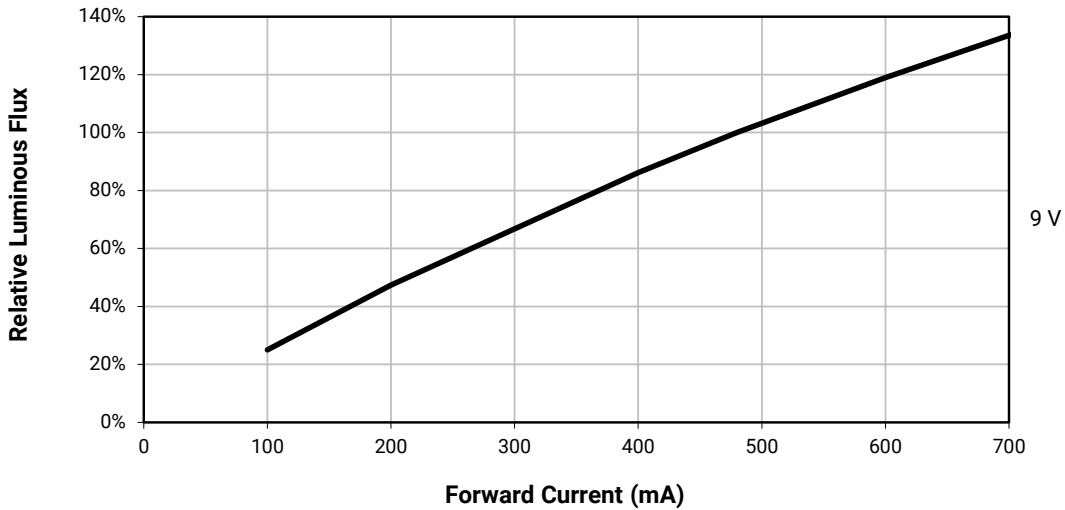

RELATIVE FLUX VS. CURRENT ( $T_j = 85\text{ }^\circ\text{C}$ ) - CONTINUED

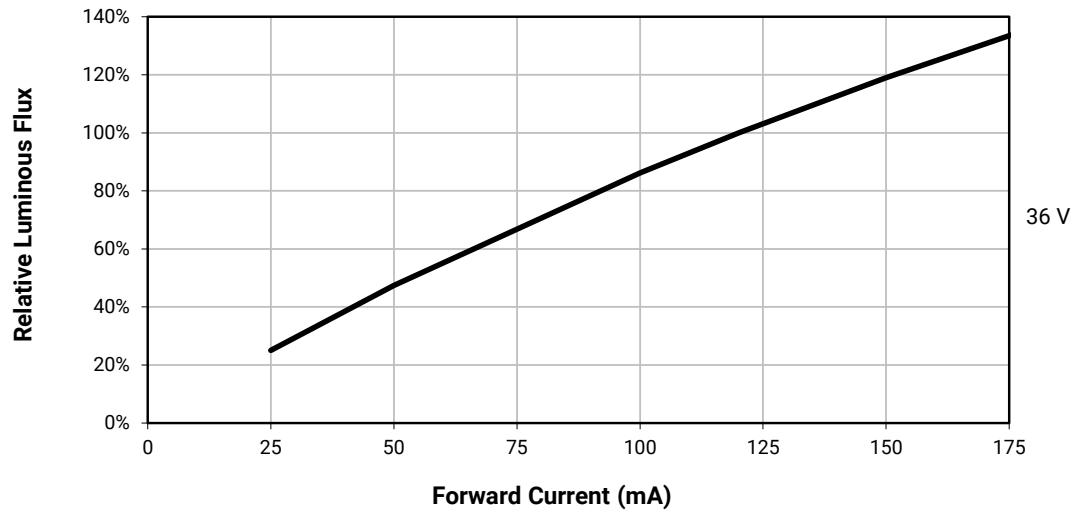
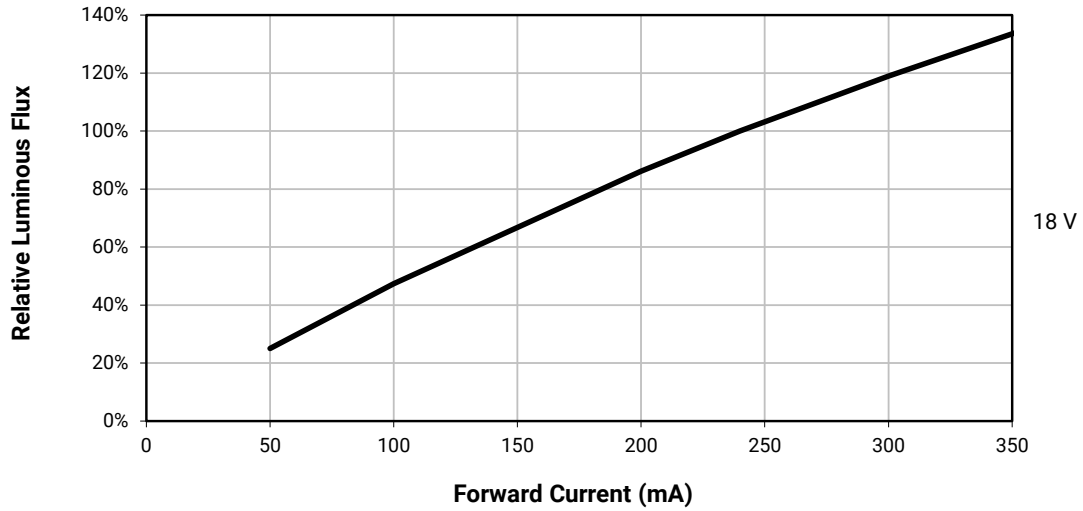

RELATIVE CHROMATICITY VS. CURRENT (WARM WHITE)

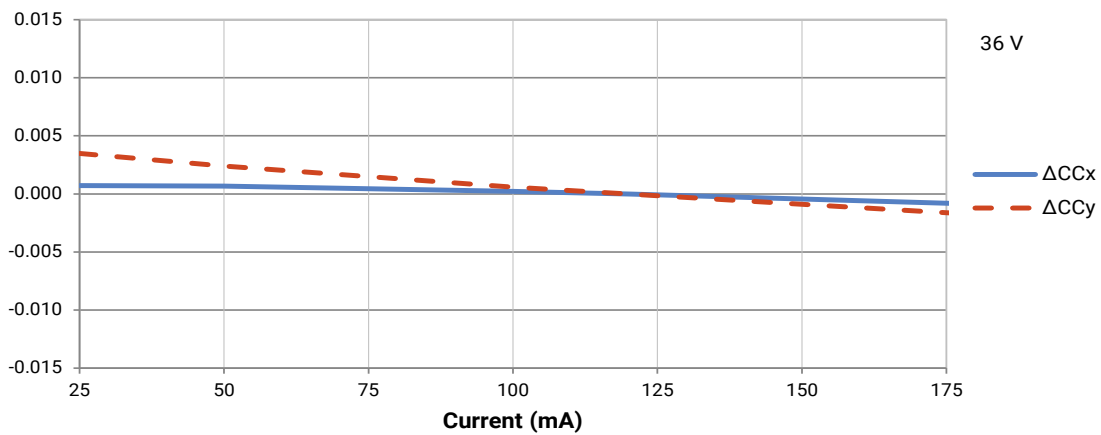
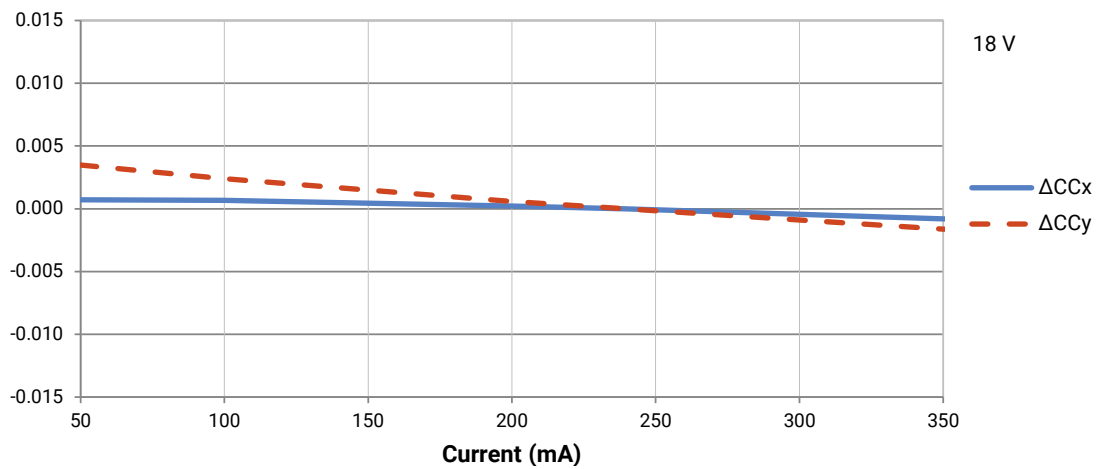
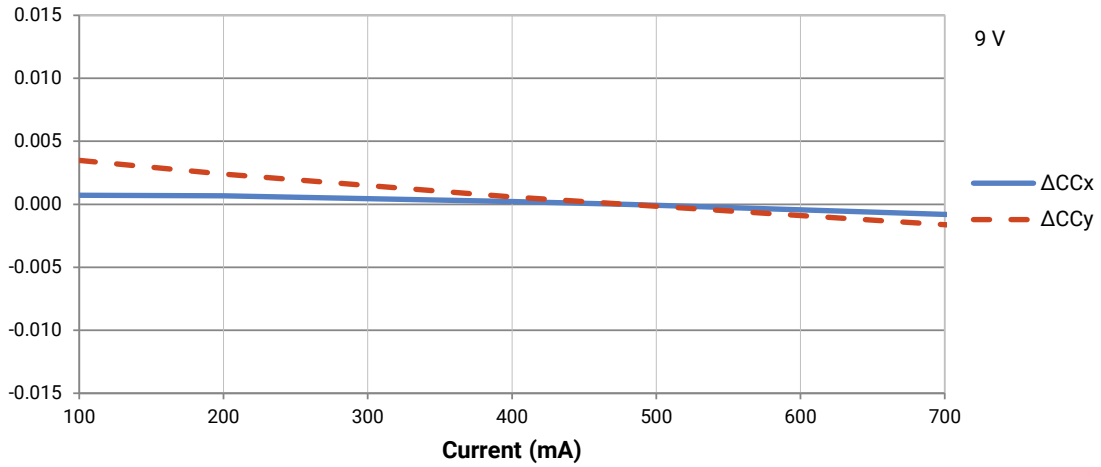



### RELATIVE CHROMATICITY VS. TEMPERATURE (WARM WHITE)

Test condition: 9 V,  $I_f = 480$  mA; 18 V,  $I_f = 240$  mA; 36 V,  $I_f = 120$  mA

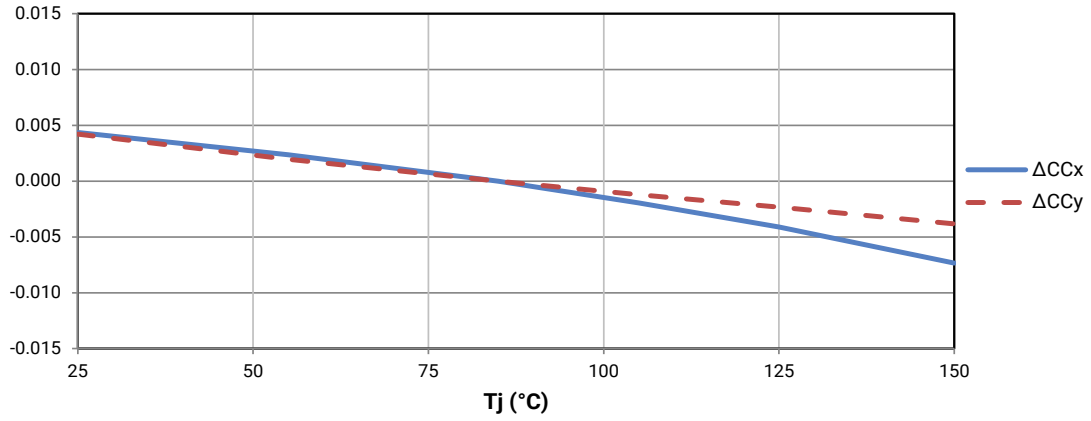

### TYPICAL SPATIAL DISTRIBUTION

Test condition: 9 V,  $I_f = 480$  mA; 18 V,  $I_f = 240$  mA; 36 V,  $I_f = 120$  mA

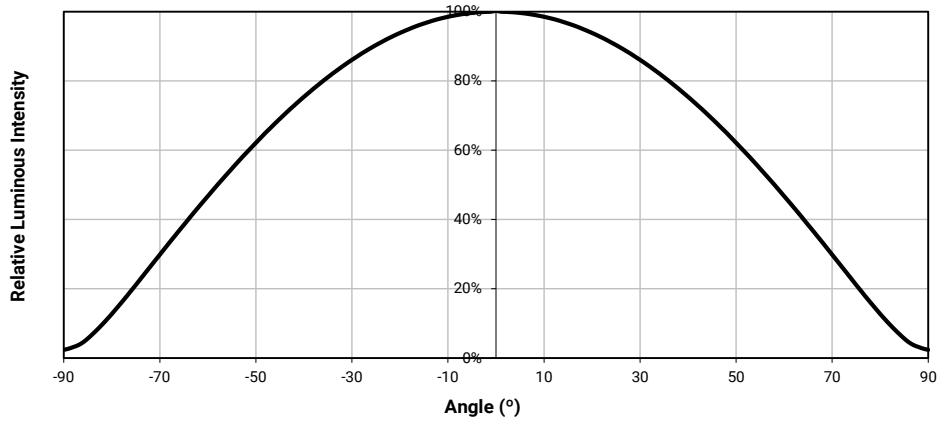

THERMAL DESIGN

The maximum forward current is determined by the thermal resistance between the LED junction and ambient. It is crucial for the end product to be designed in a manner that minimizes the thermal resistance from the solder point to ambient in order to optimize lamp life and optical characteristics.

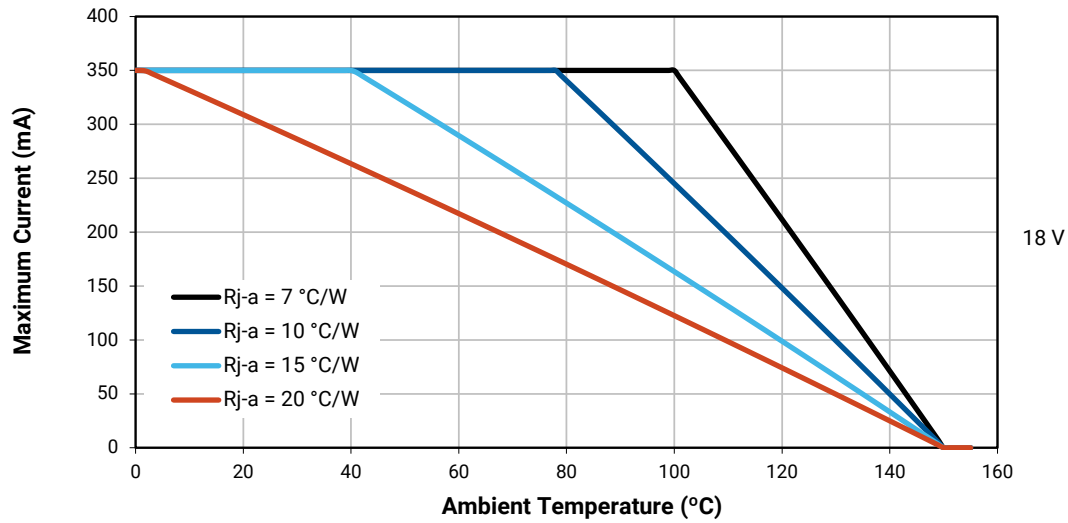
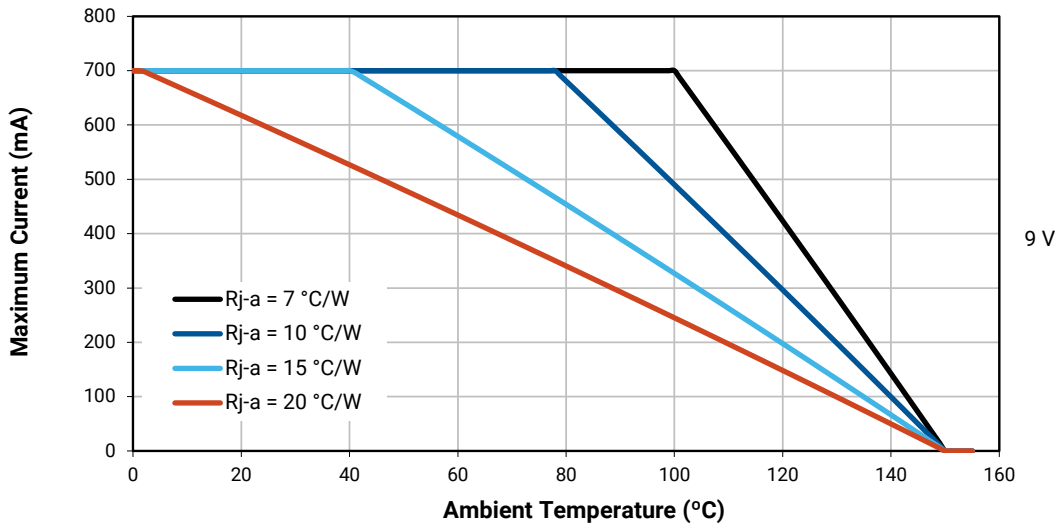

THERMAL DESIGN - CONTINUED

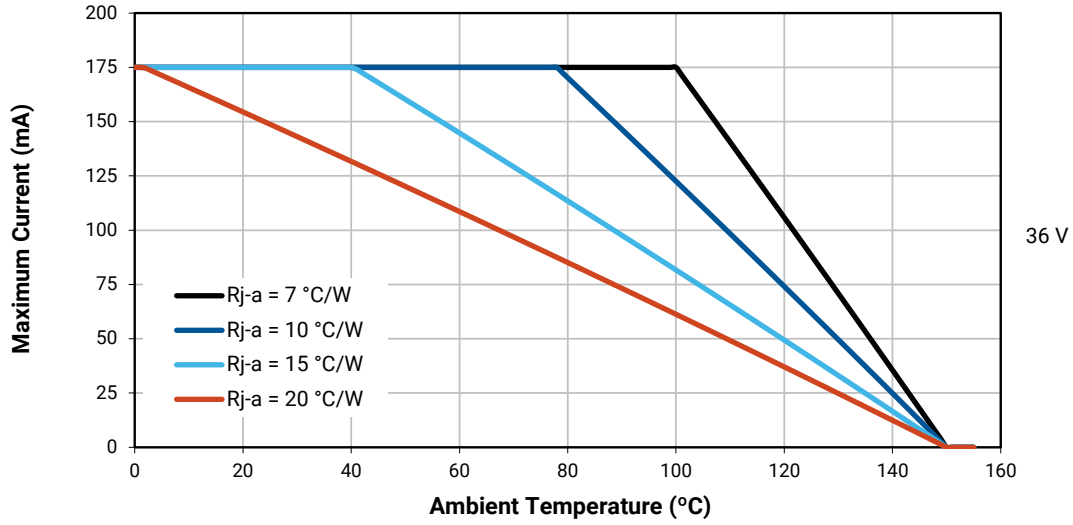

PERFORMANCE GROUPS – LUMINOUS FLUX (T<sub>j</sub> = 85 °C)

XLamp MHB-A LEDs are tested for luminous flux and placed into one of the following bins.

Group Code	Minimum Luminous Flux	Maximum Luminous Flux
A2	330	355
A4	355	380
B2	380	410
B4	410	440
C2	440	475
C4	475	510
D2	510	550
D4	550	590
E2	590	635
E4	635	680

**PERFORMANCE GROUPS – CHROMATICITY**

XLamp MHB-A LEDs are tested for chromaticity and placed into one of the regions defined by the following bounding coordinates.

EasyWhite Color Temperatures – 2-Step			
Code	CCT	x	y
40H	4000 K	0.3777	0.3739
		0.3797	0.3816
		0.3861	0.3855
		0.3838	0.3777
35H	3500 K	0.4022	0.3858
		0.4053	0.3942
		0.4125	0.3977
		0.4091	0.3891
30H	3000 K	0.4287	0.3975
		0.4328	0.4064
		0.4390	0.4086
		0.4347	0.3996
27H	2700 K	0.4524	0.4048
		0.4574	0.4140
		0.4633	0.4154
		0.4581	0.4062

EasyWhite Color Temperatures – 3-Step Ellipse						
Bin Code	CCT	Center Point		Major Axis	Minor Axis	Rotation Angle (°)
		x	y	a	b	
50G	5000 K	0.3447	0.3553	0.00840	0.00312	65.0
40G	4000 K	0.3818	0.3797	0.00939	0.00402	53.7
35G	3500 K	0.4073	0.3917	0.00927	0.00414	53.2
30G	3000 K	0.4338	0.4030	0.00834	0.00408	53.2
27G	2700 K	0.4577	0.4099	0.00834	0.00420	48.5

EasyWhite Color Temperatures – 5-Step Ellipse						
Bin Code	CCT	Center Point		Major Axis	Minor Axis	Rotation Angle (°)
		x	y	a	b	
65E	6500 K	0.3123	0.3282	0.01110	0.00550	61.0
57E	5700 K	0.3287	0.3417	0.01230	0.00600	72.0
50E	5000 K	0.3447	0.3553	0.01400	0.00520	65.0
40E	4000 K	0.3818	0.3797	0.01565	0.00670	53.7

STANDARD WHITE CHROMATICITY REGIONS PLOTTED ON THE 1931 CIE CURVE

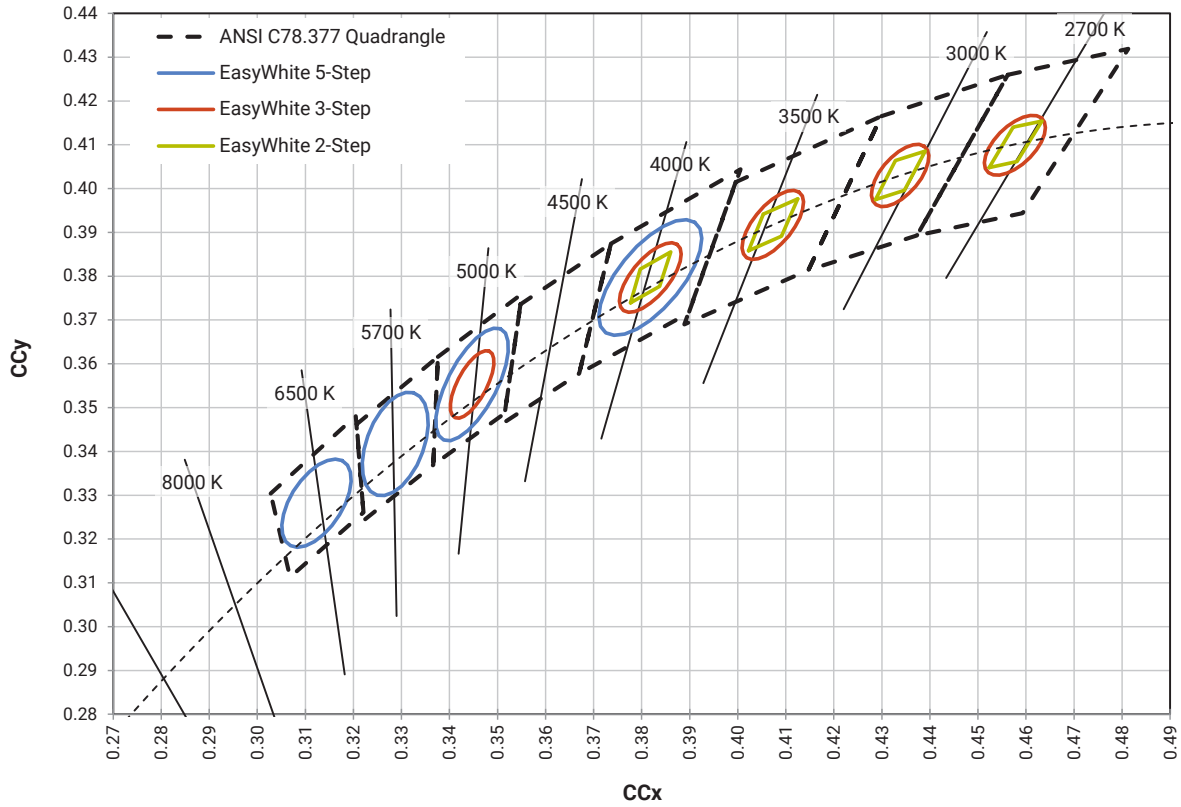

## BIN AND ORDER CODE FORMATS

Bin codes and order codes for MHB-A LEDs are configured in the following manner:

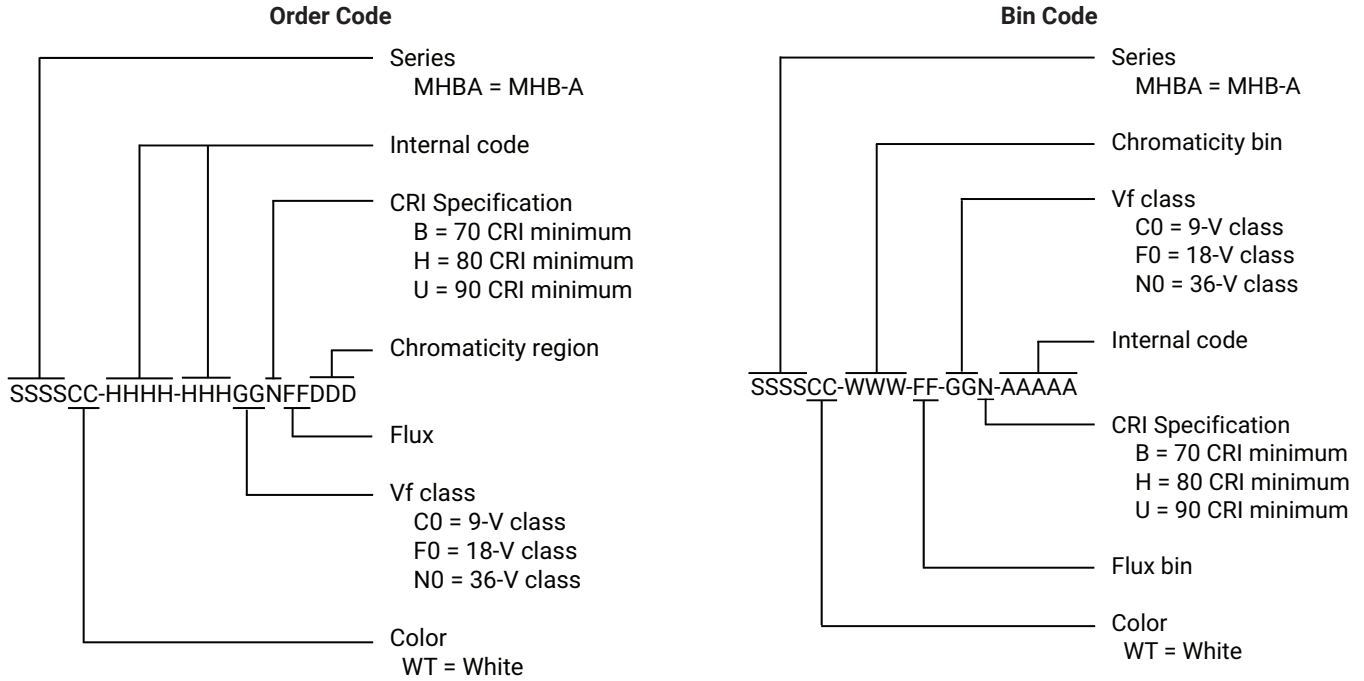

## REFLOW SOLDERING CHARACTERISTICS

In testing, Cree LED has found XLamp MHB-A LEDs to be compatible with JEDEC J-STD-020C, using the parameters listed below. As a general guideline, Cree LED recommends that users follow the recommended soldering profile provided by the manufacturer of the solder paste used, and therefore it is the lamp or luminaire manufacturer’s responsibility to determine applicable soldering requirements.

Note that this general guideline may not apply to all PCB designs and configurations of reflow soldering equipment.

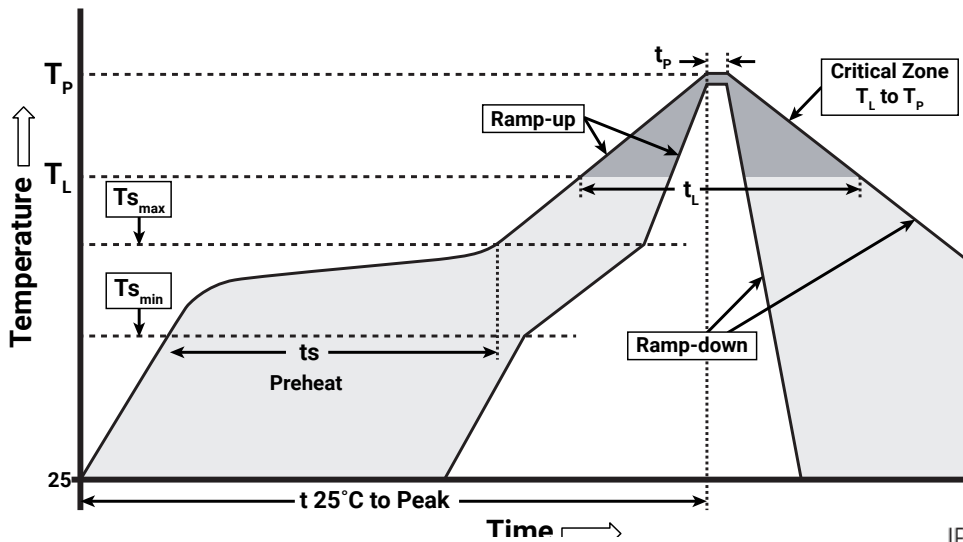

IPC/JEDEC J-STD-020C

Profile Feature	Lead-Free Solder
Average Ramp-Up Rate ( $T_{s_{max}}$ to $T_p$ )	1.2 °C/second
Preheat: Temperature Min ( $T_{s_{min}}$ )	120 °C
Preheat: Temperature Max ( $T_{s_{max}}$ )	170 °C
Preheat: Time ( $t_{s_{min}}$ to $t_{s_{max}}$ )	65-150 seconds
Time Maintained Above: Temperature ( $T_L$ )	217 °C
Time Maintained Above: Time ( $t_L$ )	45-90 seconds
Peak/Classification Temperature ( $T_p$ )	235 - 245 °C
Time Within 5 °C of Actual Peak Temperature ( $t_p$ )	20-40 seconds
Ramp-Down Rate	1 - 6 °C/second
Time 25 °C to Peak Temperature	4 minutes max.

Note: All temperatures refer to the topside of the package, measured on the package body surface.

## NOTES

---

### Measurements

The luminous flux, radiant power, chromaticity, forward voltage and CRI measurements in this document are binning specifications only and solely represent product measurements as of the date of shipment. These measurements will change over time based on a number of factors that are not within Cree LED's control and are not intended or provided as operational specifications for the products. Calculated values are provided for informational purposes only and are not intended or provided as specifications.

### Pre-Release Qualification Testing

Please read the [LED Reliability Overview](#) for details of the qualification process Cree LED applies to ensure long-term reliability for XLamp LEDs and details of Cree LED's pre-release qualification testing for XLamp LEDs.

### Lumen Maintenance

Cree LED now uses standardized IES LM-80-08 and TM-21-11 methods for collecting long-term data and extrapolating LED lumen maintenance. For information on the specific LM-80 data sets available for this LED, refer to the public [LM-80 results document](#).

Please read the [Long-Term Lumen Maintenance application note](#) for more details on Cree LED's lumen maintenance testing and forecasting. Please read the [Thermal Management application note](#) for details on how thermal design, ambient temperature, and drive current affect the LED junction temperature.

### Moisture Sensitivity

Cree LED recommends keeping XLamp LEDs in the provided, resealable moisture-barrier packaging (MBP) until immediately prior to soldering. Unopened MBPs that contain XLamp LEDs do not need special storage for moisture sensitivity.

Once the MBP is opened, XLamp MHB-A LEDs may be stored as MSL 1 per JEDEC J-STD-033, meaning they have unlimited floor life in conditions of  $\leq 30$  °C/85% relative humidity (RH). Regardless of the storage condition, Cree LED recommends sealing any unsoldered LEDs in the original MBP.

### RoHS Compliance

The levels of RoHS restricted materials in this product are below the maximum concentration values (also referred to as the threshold limits) permitted for such substances, or are used in an exempted application, in accordance with EU Directive 2011/65/EC (RoHS2), as implemented January 2, 2013. RoHS Declarations for this product can be obtained from your Cree LED representative or from the [Product Ecology](#) section of the Cree LED website.

### REACH Compliance

REACH substances of very high concern (SVHCs) information is available for this product. Since the European Chemical Agency (ECHA) has published notice of their intent to frequently revise the SVHC listing for the foreseeable future, please contact a Cree LED representative to insure you get the most up-to-date REACH Declaration. REACH banned substance information (REACH Article 67) is also available upon request.



## NOTES - CONTINUED

---

### **UL® Recognized Component**

This product meets the requirements to be considered a UL Recognized Component with Level 4 enclosure consideration. The LED package or a portion thereof has been investigated as a fire and electrical enclosure per ANSI/UL 8750.

### **Vision Advisory**

WARNING: Do not look at an exposed lamp in operation. Eye injury can result. For more information about LEDs and eye safety, please refer to the [LED Eye Safety application note](#).

## MECHANICAL DIMENSIONS

Thermal vias, if present, are not shown on these drawings.  
 All measurements are  $\pm 0.13$  mm unless otherwise indicated.

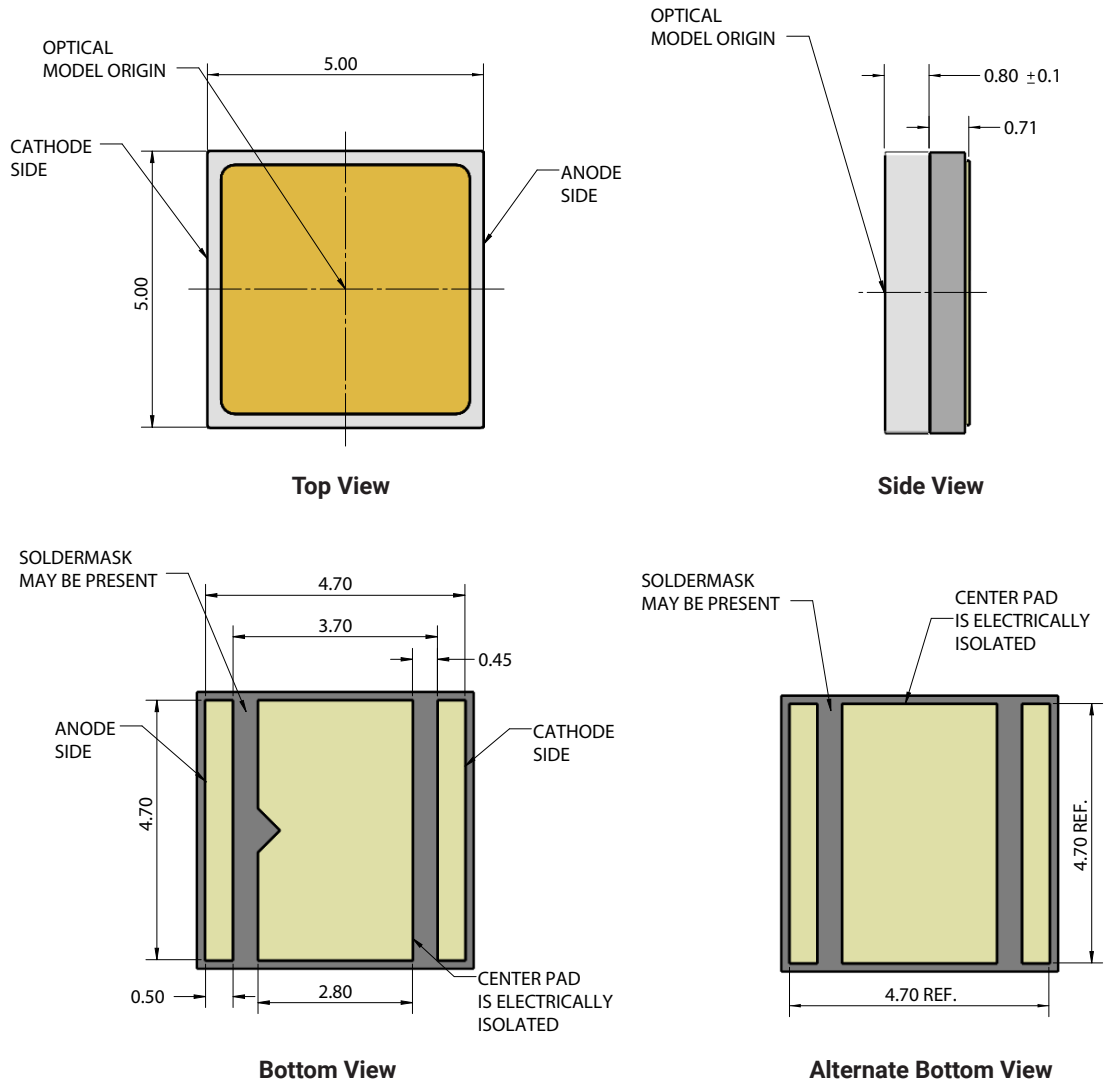

MECHANICAL DIMENSIONS - CONTINUED

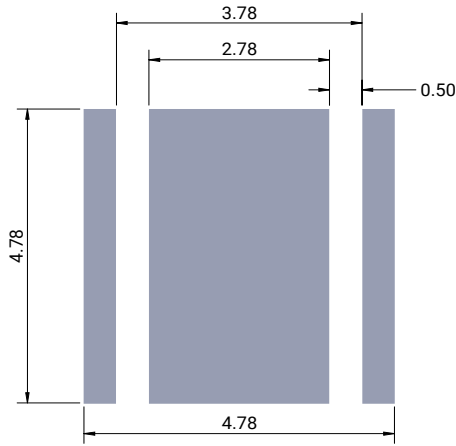

Recommended PCB Footprint

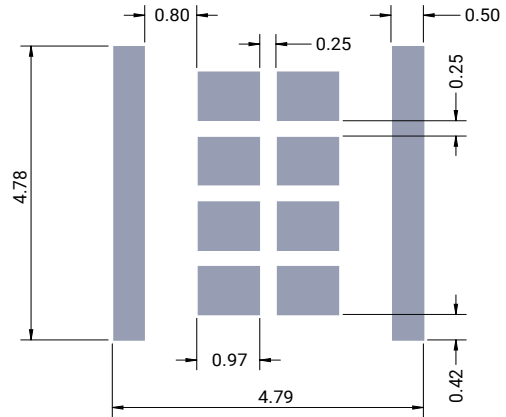

Recommended Stencil Opening

**TAPE AND REEL**

All Cree LED carrier tapes conform to EIA-481D, Automated Component Handling Systems Standard.

All dimensions in mm

All dimensions are ±.13 mm unless otherwise indicated.

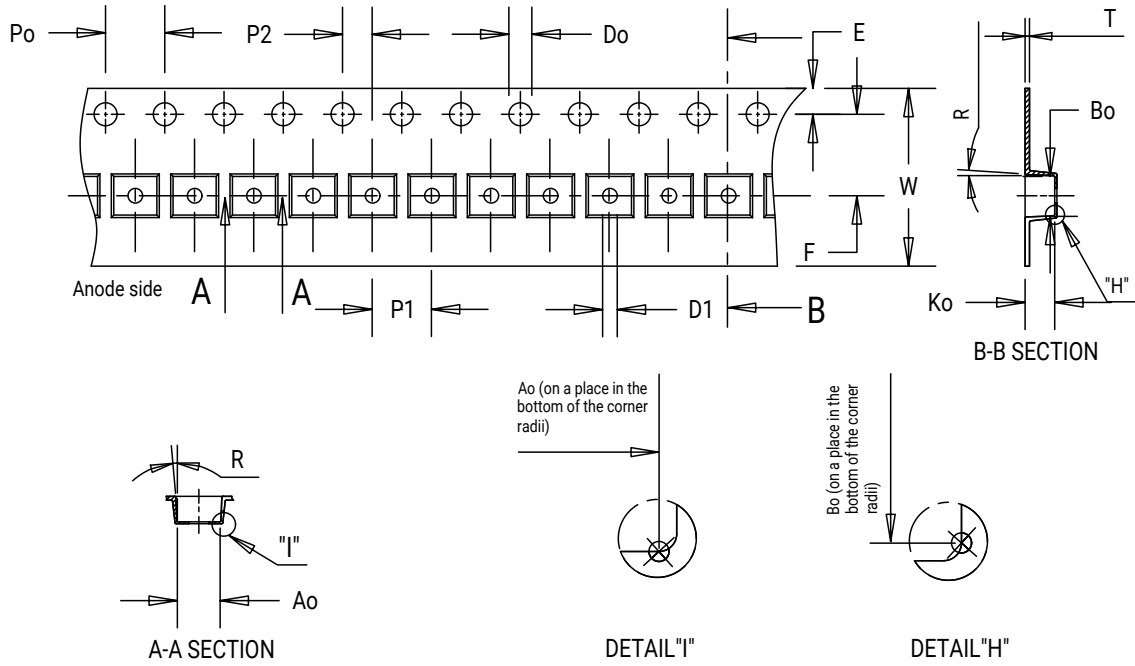

Item	Ao	Bo	Ko	Po	P1	P2	T	E	F	Do	D1	W	R
Dim.	5.4	5.40	1.50	4.00	8.00	2.00	0.30	1.75	5.50	1.50	1.50	12.00	7°

TAPE AND REEL - CONTINUED

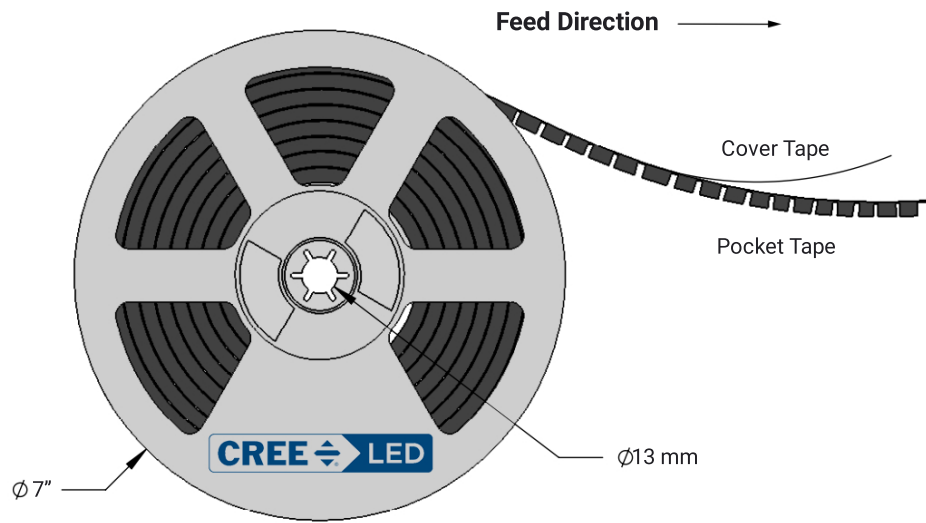
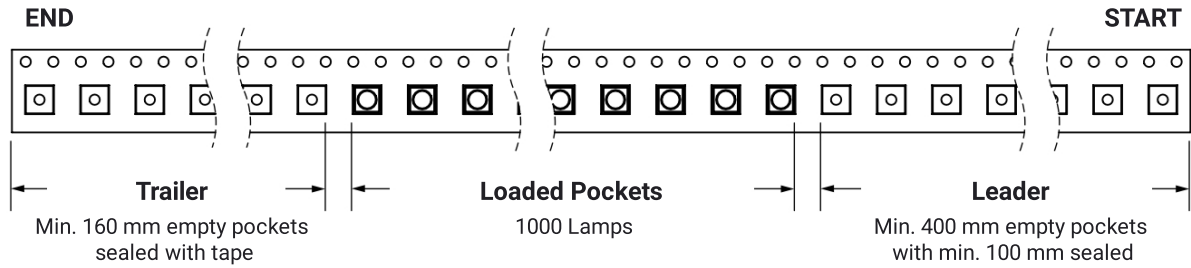

## PACKAGING

### Unpackaged Reel

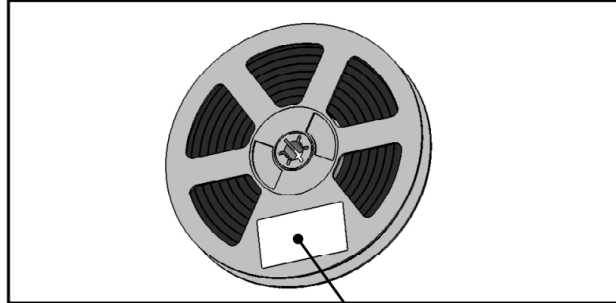

Label with Cree LED Bin Code, Quantity, Reel ID

### Packaged Reel

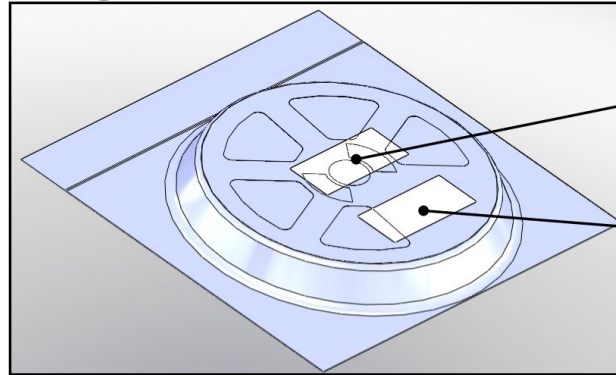

Label with Cree LED Order Code, Quantity, Reel ID, PO#

Label with Cree LED Bin Code, Quantity, Reel ID

### Boxed Reel

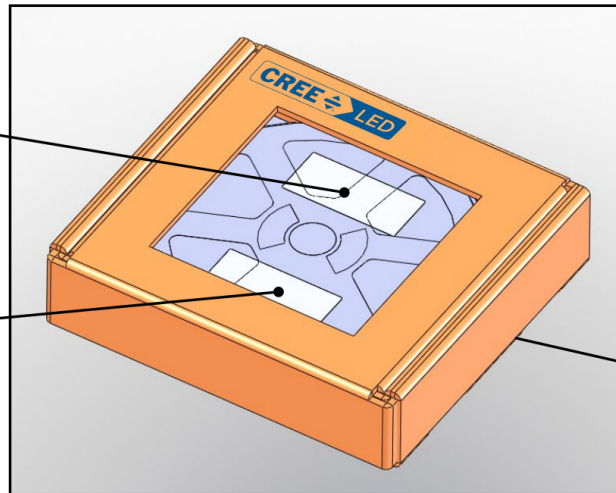

Label with Cree LED Order Code, Quantity, Reel ID, PO#

Label with Cree LED Bin Code, Quantity, Reel ID

Patent Label (on bottom of box)