



健隆投資有限公司
STRONG BASE INVESTMENT LTD.

Unit 17, 11/F., Hewlett Centre, 52-54 Hoi Yuen Road, Kwun Tong, Kowloon, Hong Kong.
Tel: (852) 2793 3293 Fax: (852) 2793 3096



Approval Sheet
(確認書)

編號 Ref. No.	
日期 Issued Date	2015-10-28

公司名稱 : _____
Company Name

產品編號 : 10Y3HD-15
Part No.

產品種類 : LED-LAMP
Category

產品描述 : 10MM/ HIGH BRIGHT YELLOW, YELLOW DIFFUSED
Description

客戶產品編號 : _____
Customer No.

備注 : _____
Remarks

STRONG BASE			
SSUER	APPROVER	CHECKER	ENGINEER
	朱美丽	叶楠	高雪

Authorized Signature 客戶簽字				
部門 Department				
簽字 Signature				

工廠名稱:宇之亮電子(深圳)有限公司
工廠地址:廣東省深圳市龍崗區橫崗鎮荷坳村金源工業區
Company Name: Pretty Light (Shen Zhen) Limited
Factory Address:jin-Yuan,Industrial Zone He-Ao Cun,Heng-Gang
Zhen Long-Gang Area,Shen-Zhen City,
TEL: (755) 8976 6931 28696588 FAX: (755) 89767754 89767566

PART NO. : 10Y3HD-15

DATE : 2 November 2015

10MM/ HIGH BRIGHT YELLOW, YELLOW DIFFUSED

SPECIFICATION

ABSOLUTE MAXIMUM RATING (Ta=25°C)

Item	Symbol	Rating	Unit
Power Dissipation	P _D	70	mW
Forward Current	I _F	20	mA
Peak Forward Current (1/10 Duty Cycle, 0.1 ms Pulse Width)	I _{FP}	100	mA
Reverse Voltage	V _R	5	V
Operating Temperature	T _{opr}	-40~+80	°C
Storage Temperature	T _{stg}	-40~+80	°C

ELECTRICAL/OPTICAL CHARACTERISTICS RATING (Ta=25°C)

Item	Symbol	Test Conditions	Rating			Unit
			Min.	Typ.	Max.	
Forward Voltage	V _F	I _F =20mA	1.8	2.1	2.8	V
Reverse Current	I _R	V _R =5V	---	---	10	μA
Luminous Intensity	I _v	I _F =20mA	---	30	---	mcd
Dominant Wave Length	λ _d	I _F =20mA	---	590	---	nm
Viewing Angle 2θ _{1/2}	2θ _{1/2}	I _F =20mA	50°			deg.

Notes:-

1) θ_{1/2} is the off-axis angle where the luminous intensity is half the optical centerline value.

Soldering Conditions : Soldering Temp. ≤ 260°C

Soldering Time ≤ 5 Sec.



Caution : ESD protection measures shall be considered and taken in the initial design stage, because static electricity and surge could damage the LED.

A wrist band or an anti-electrostatic glove should be used when handling

Electrostatic Sensitive Devices.

PART NO. : 10Y3HD-15

DATE : 2 November 2015

10MM/ HIGH BRIGHT YELLOW, YELLOW DIFFUSED

PACKAGE DIMENSION

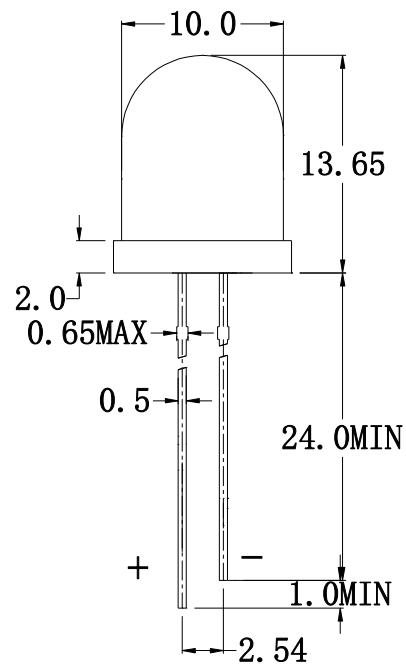
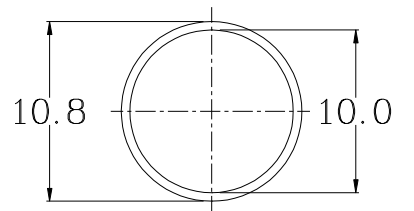
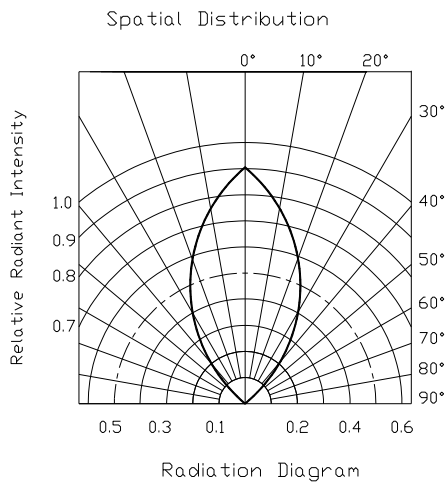

Tolerance: ± 0.25(0.01)
Unit: mm(inch)

Item	Materials
Resin(Mold)	Epoxy Resin
Lead Frame	Copper Alloy

Part Number	Emitting Color	Lens Type
10Y3HD-15	YELLOW	YELLOW DIFFUSED

PART NO. : 10Y3HD-15

DATE : 2 November 2015

10MM/ HIGH BRIGHT YELLOW, YELLOW DIFFUSED

Typical Electrical/Optical Characteristics Curves

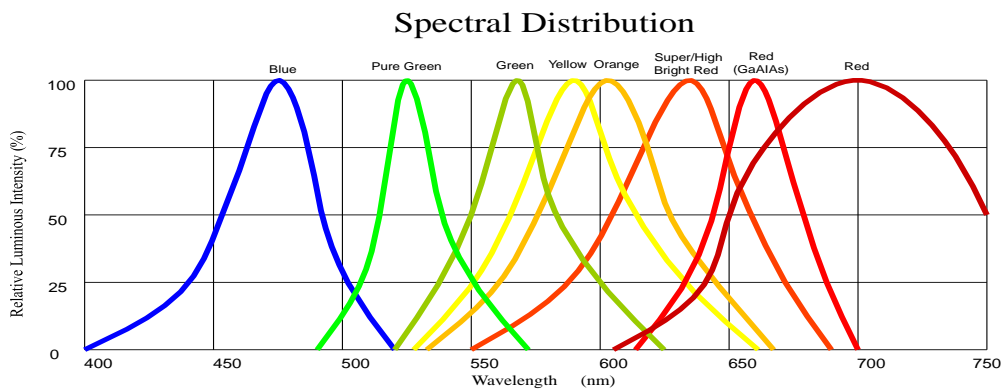

(25°C) Ambient Temperature Unless Otherwise Noted

Fig1. Forward Current vs Forward Voltage

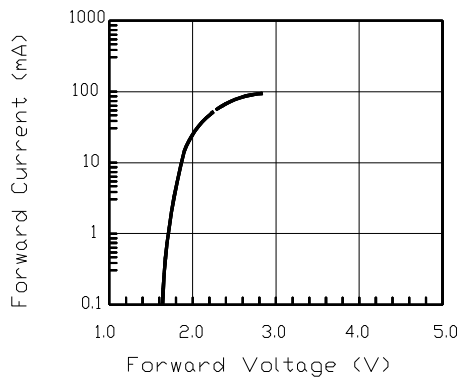

Fig2 Relative Luminous Intensity Vs Forward current

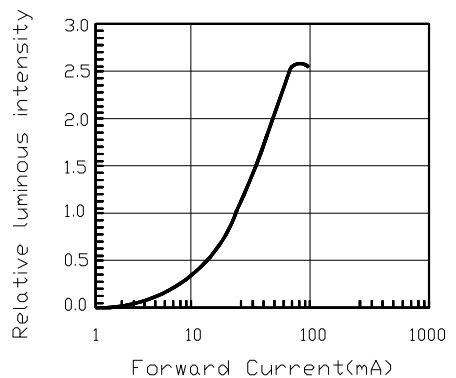

Fig3. Forward Current Derating Curve

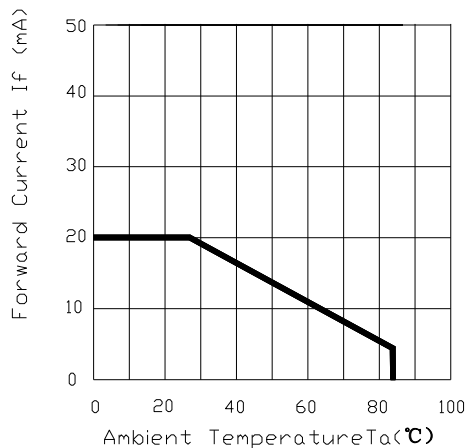

Fig4. Relative Luminous Intensity vs Ambient Temperature

