



TOYO LED ELECTRONICS LIMITED

Room 1610, Hong Kong Plaza, 188 Connaught Road West, Hong Kong.
Tel : (852) 2540 7288 Fax : (852) 2517 1797
http://www.toyo-led.com E-mail : sales@toyo-led.com



P/N: TY-YSV1204BL1(1.50)

1204 Package 3.2*1.0mm Surface Mount LEDs Series

✧ Features:

- 3.2mm x 1.0mm SMT LED, 1.50mm thickness
- Mono-color type
- Soldering methods :All SMT assembly methods
- Comply ROHS standard

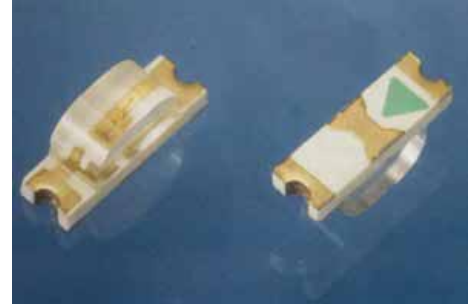

✧ Description

The Blue source color devices are made with **InGaN** on sapphire Light Emitting Diode.

✧ Application

- Optical indicator
- Indicator and backlighting in telephone and fax
- Flat backlight for LCD, switch and symbol
- Light pipe application
- General use

✧ Package Dimensions

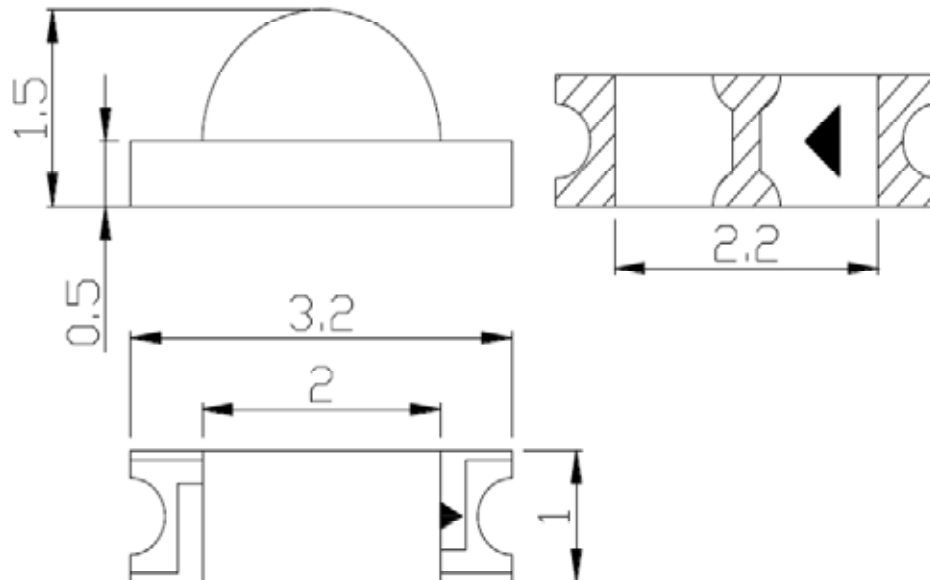

NOTES :

1. All dimensions are in millimeter[unit];
2. Tolerance is $\pm 0.1\text{mm}$ (0.004") unless other specified;
3. Specifications are subject to change without notice.



TOYO LED ELECTRONICS LIMITED

Room 1610, Hong Kong Plaza, 188 Connaught Road West, Hong Kong.
 Tel : (852) 2540 7288 Fax : (852) 2517 1797
 http://www.toyo-led.com E-mail : sales@toyo-led.com



P/N: TY-YSV1204BL1(1.50)

1204 Package 3.2*1.0mm Surface Mount LEDs Series

Part No.	Emitted Color	Lens Color	Chip Material
TY-YSV1204BL1(1.50)	Blue	Water clear	InGaN

◇ Absolute Maximum Ratings(Ta=25)

Item	Symbol	Maximum	Unit
Power Dissipation	PD	135	mW
Continuous Forward Current	I _{Fmax}	30	mA
Peak Forward Current(1/10 Duty Cycle 0.1ms Pulse Width)	I _{FP}	140	mA
Reverse Voltage	V _R	5	V
Operating Temperature Range	T _{opr}	-40 to+85	
Storage Temperature Range	T _{stg}	-40 to+85	

◇ Electrical/Optical Characteristics(Ta=25)

Item	Symbol	Condition	Min.	Typ.	Max	Unit
Forward Voltage	V _F	I _F =20mA	--	3.0	3.4	V
Luminous Intensity	I _V	I _F =20mA	100	150	--	mcd
Dominate Wavelength	λ_d	I _F =20mA	--	466	468	nm
Viewing Angle	2 $\theta_{1/2}$	I _F =20mA	---	120	---	Deg
Reverse Current	I _R	V _R =5V	---	---	10	uA



TOYO LED ELECTRONICS LIMITED

Room 1610, Hong Kong Plaza, 188 Connaught Road West, Hong Kong.
Tel : (852) 2540 7288 Fax : (852) 2517 1797
http://www.toyo-led.com E-mail : sales@toyo-led.com



P/N: TY-YSV1204BL1(1.50)

1204 Package 3.2*1.0mm Surface Mount LEDs Series

◇ Typical Electro-Optical Characteristics Curves

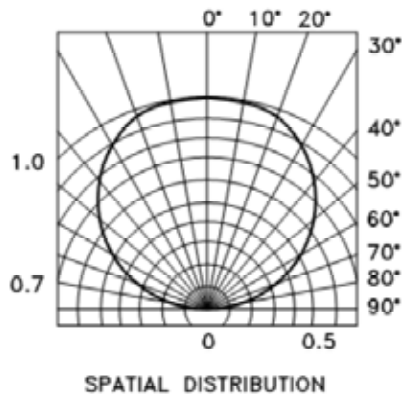
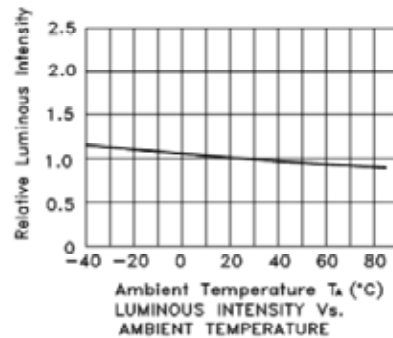
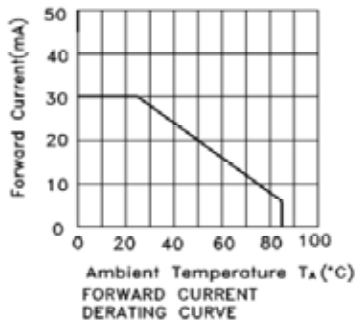
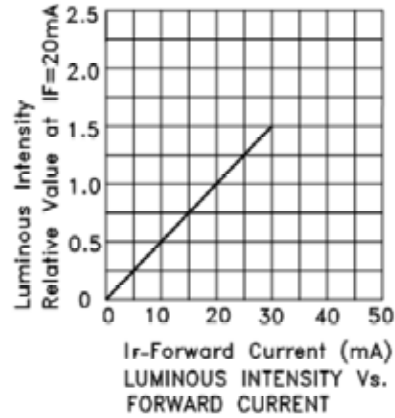
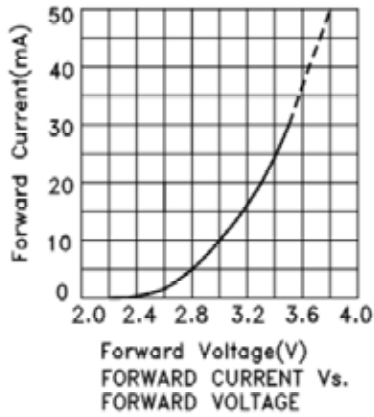
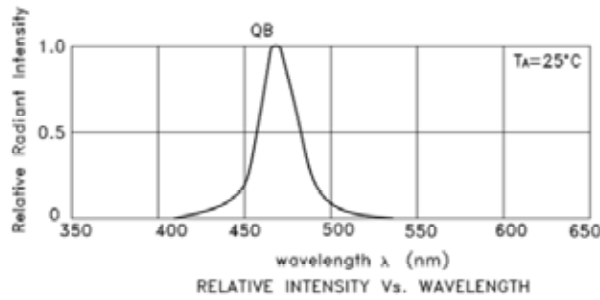



TOYO LED ELECTRONICS LIMITED

Room 1610, Hong Kong Plaza, 188 Connaught Road West, Hong Kong.
Tel : (852) 2540 7288 Fax : (852) 2517 1797
http://www.toyo-led.com E-mail : sales@toyo-led.com



P/N: TY-YSV1204BL1(1.50)

1204 Package 3.2*1.0mm Surface Mount LEDs Series

◇ Reliability Test Items And Conditions

NO.	Item	Test Condition	Test Hr/cycle/time	Sample Q'ty	Ac/Re
1	Reflow	TEMP:260±5 ; Min.5Sec	6 min	22pcs	0/1
2	Temperature Cycle	H:+100 15mins To(5mins) L:-40 15mins	300 cycles	22pcs	0/1
3	Thermal Shock	H:+100 15mins To(5mins) L:-40 15mins	300 cycles	22pcs	0/1
4	High Temperature Storage	TEMP:+260	1000hrs	22pcs	0/1
5	Low Temperature Storage	TEMP:-40	1000hrs	22pcs	0/1
6	DC Operating Life	IF=20MA	1000hrs	22pcs	0/1
7	High Temperature	85	1000hrs	22pcs	0/1
8	High Humidity	85%R.H.	1000hrs	22pcs	0/1

Rework

1. Customer must finish rework within 5 sec under 245°C.
2. The head of iron can not touch copper foil.
3. Twin-head type is preferred.

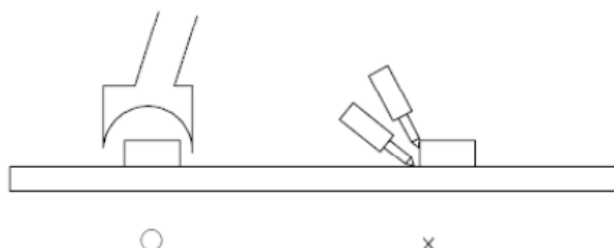



TOYO LED ELECTRONICS LIMITED

Room 1610, Hong Kong Plaza, 188 Connaught Road West, Hong Kong.
Tel : (852) 2540 7288 Fax : (852) 2517 1797
http://www.toyo-led.com E-mail : sales@toyo-led.com



P/N: TY-YSV1204BL1(1.50)

1204 Package 3.2*1.0mm Surface Mount LEDs Series

❖ Precautions For Use

1. Over-current-proof

Customer must apply resistors for protection , otherwise slight voltage shift will cause big current change (Burn out will happen).

2. Storage time

2.1 The operation of Temperature and RH are : $5^{\circ}\text{C}\sim 35^{\circ}\text{C}$, RH60%.

2.2 Once the package is opened, the products should be used within a week. Otherwise, they should be kept in a damp proof box with desiccating agent. Considering the tape life , we suggest our customers to use our products within a year(from production date).

2.3 If opened more than one week in an atmosphere $5^{\circ}\text{C}\sim 35^{\circ}\text{C}$, RH 60%, they should be treated at $60^{\circ}\text{C}\pm 5^{\circ}\text{C}$ for 15hrs.

2.4 When you discover that the desiccant in the package has a pink color (Normal = blue) , you should treat them in the same conditions as 2.3.

Soldering heat

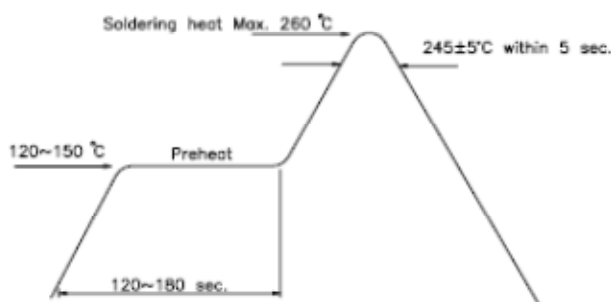

Reflow Temp / Time

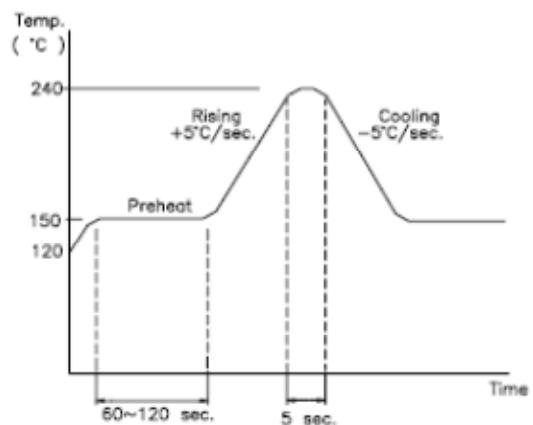

Soldering Iron

Basic spec is ≤ 5 sec when 260°C . If temperature is higher, time should be shorter ($+10^{\circ}\text{C}\rightarrow -1$ sec). Power dissipation of Iron should be smaller than 15 W , and temperature should be controllable. Surface temperature of the device should be under 230°C .



TOYO LED ELECTRONICS LIMITED

Room 1610, Hong Kong Plaza, 188 Connaught Road West, Hong Kong.
Tel : (852) 2540 7288 Fax : (852) 2517 1797
http://www.toyo-led.com E-mail : sales@toyo-led.com



P/N: TY-YSV1204BL1(1.50)

1204 Package 3.2*1.0mm Surface Mount LEDs Series

◇ Recommended Soldering Pad Dimensions

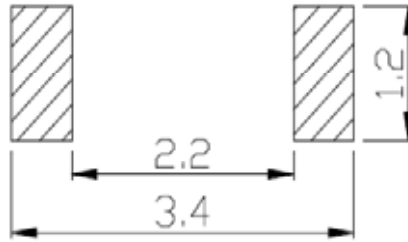

◇ Tape Specification: 2,000PCS per reel

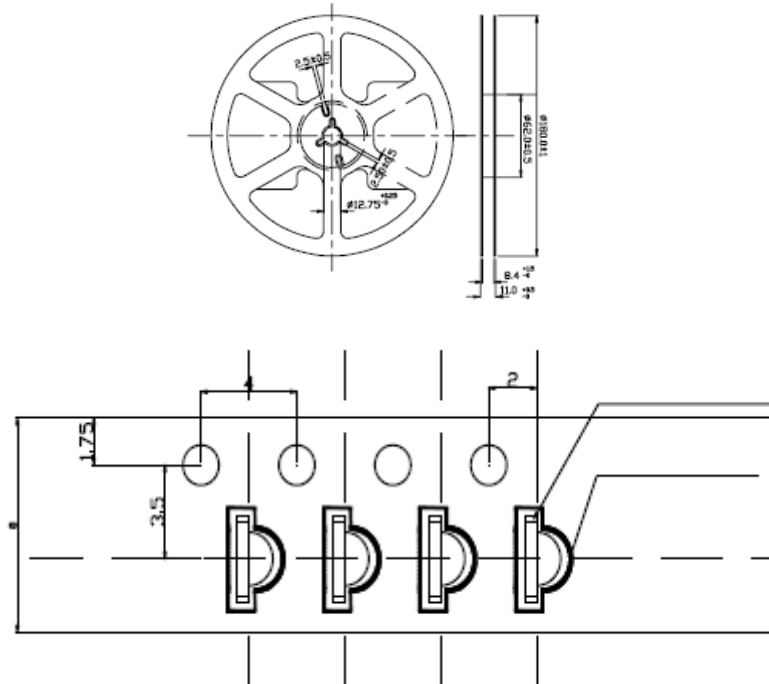

◇ Package Label

SMD LED	
PART NO: _____	QA Pass
LOT NO : _____	
Q' TY : _____	Pb
VF : _____ IV : _____	
WL : _____ BIN: _____	
DATA : _____	
TOYO LED ELECTRONICS LIMITED	
Website: http://www.toyo-led.com E-mail: sales@toyo-led.com	



TOYO LED ELECTRONICS LIMITED

Room 1610, Hong Kong Plaza, 188 Connaught Road West, Hong Kong.
Tel : (852) 2540 7288 Fax : (852) 2517 1797
http://www.toyo-led.com E-mail : sales@toyo-led.com



P/N: TY-YSV1204BL1(1.50)

1204 Package 3.2*1.0mm Surface Mount LEDs Series

❖ Package & Shipping Instructions

