



**健隆投資有限公司**  
**STRONG BASE INVESTMENT LTD.**

Unit 17, 11/F., Hewlett Centre, 52-54 Hoi Yuen Road, Kwun Tong, Kowloon, Hong Kong.  
Tel: (852) 2793 3293 Fax: (852) 2793 3096



**Approval Sheet**  
**(確認書)**

<b>編號</b> Ref. No.	
<b>日期</b> Issued Date	2015-10-28

**公司名稱** : \_\_\_\_\_  
Company Name

**產品編號** : 10R3UD-6  
Part No.

**產品種類** : LED-LAMP  
Category

**產品描述** : 10MM/ SUPER BRIGHT RED,RED DIFFUSED  
Description

**客戶產品編號** : \_\_\_\_\_  
Customer No.

**備注** : \_\_\_\_\_  
Remarks

STRONG BASE			
ISSUER	APPROVER	CHECKER	ENGINEER
	朱美丽	叶楠	高雪

Authorized Signature 客戶簽字				
部門 Department				
簽字 Signature				

工廠名稱:宇之亮電子(深圳)有限公司  
工廠地址:廣東省深圳市龍崗區橫崗鎮荷坳村金源工業區  
Company Name: Pretty Light (Shen Zhen) Limited  
Factory Address:jin-Yuan,Industrial Zone He-Ao Cun,Heng-Gang  
Zhen Long-Gang Area,Shen-Zhen City,  
TEL: (755) 89767303 89767490 FAX: (755) 89767554 89767566

**PART NO. : 10R3UD-6**

**DATE : 11 November 2015**

10MM/ SUPER BRIGHT RED, RED DIFFUSED

**SPECIFICATION**

**ABSOLUTE MAXIMUM RATING (Ta=25°C)**

Item	Symbol	Rating	Unit
Power Dissipation	P <sub>D</sub>	80	mW
Forward Current	I <sub>F</sub>	20	mA
Peak Forward Current (1/10 Duty Cycle, 0.1 ms Pulse Width)	I <sub>FP</sub>	100	mA
Reverse Voltage	V <sub>R</sub>	5	V
Operating Temperature	T <sub>opr</sub>	-40~+80	°C
Storage Temperature	T <sub>stg</sub>	-40~+80	°C

**ELECTRICAL/OPTICAL CHARACTERISTICS RATING (Ta=25°C)**

Item	Symbol	Test Conditions	Rating			Unit
			Min.	Typ.	Max.	
Forward Voltage	V <sub>F</sub>	I <sub>F</sub> =20mA	1.8	2.0	2.4	V
Reverse Current	I <sub>R</sub>	V <sub>R</sub> =5V	---	---	20	μA
Luminous Intensity	I <sub>v</sub>	I <sub>F</sub> =20mA	---	100	---	mcd
Dominant Wave Length	λ <sub>d</sub>	I <sub>F</sub> =20mA	---	635	---	nm
Viewing Angle 2θ <sub>1/2</sub>	2θ <sub>1/2</sub>	I <sub>F</sub> =20mA	50°			deg.

**Notes:-**

1) θ<sub>1/2</sub> is the off-axis angle where the luminous intensity is half the optical centerline value.

**Soldering Conditions** : Soldering Temp. ≤ 260°C

Soldering Time ≤ 5 Sec.



**Caution** : ESD protection measures shall be considered and taken in the initial design stage, because static electricity and surge could damage the LED.

A wrist band or an anti-electrostatic glove should be used when handling Electrostatic Sensitive Devices.



**PART NO. : 10R3UD-6**

**DATE : 11 November 2015**

10MM/ SUPER BRIGHT RED,RED DIFFUSED

**PACKAGE DIMENSION**

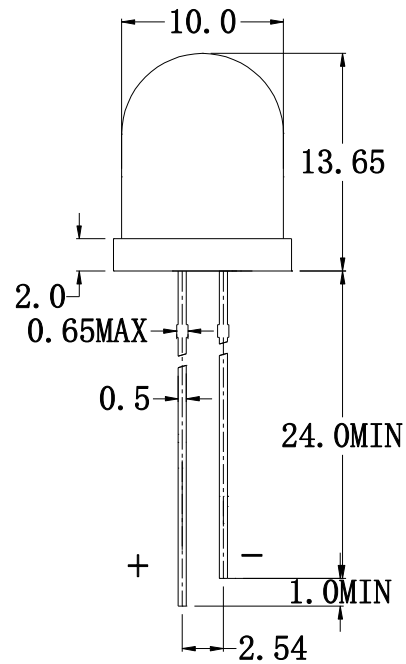
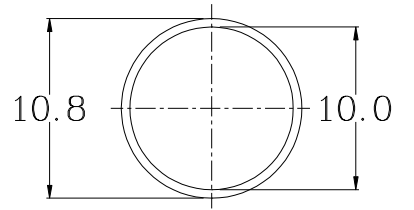
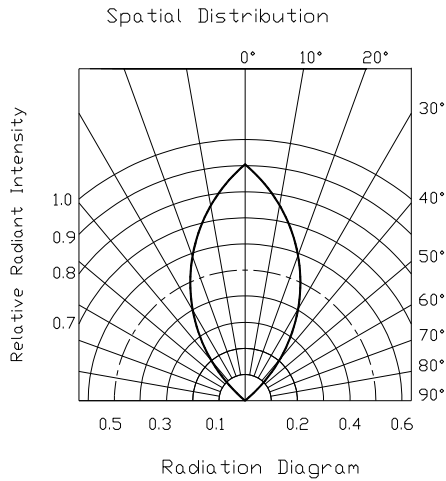

**Tolerance:  $\pm 0.25(0.01)$**

**Unit: mm(inch)**

Item	Materials
Resin(Mold)	Epoxy Resin
Lead Frame	Copper Alloy

Part Number	Emitting Color	Lens Type
10R3UD-6	RED	RED DIFFUSED

**PART NO. : 10R3UD-6**

**DATE : 11 November 2015**

10MM/ SUPER BRIGHT RED,RED DIFFUSED

**Typical Electrical/Optical Characteristics Curves**

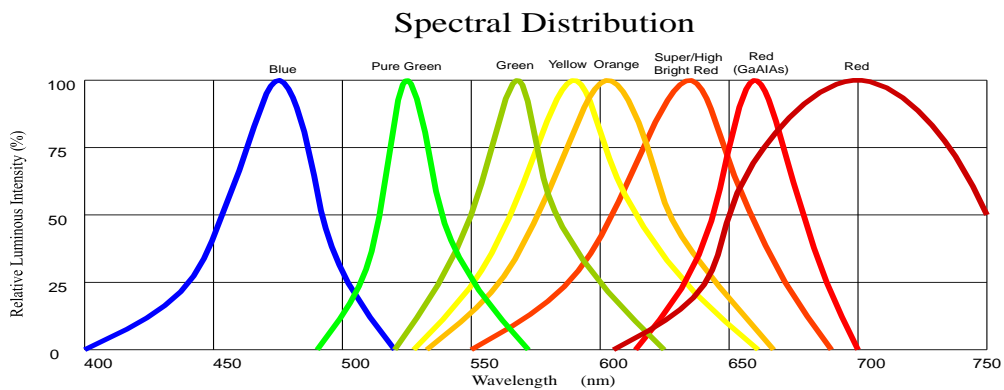

(25°C) Ambient Temperature Unless Otherwise Noted

Fig1. Forward Current vs. Forward Voltage

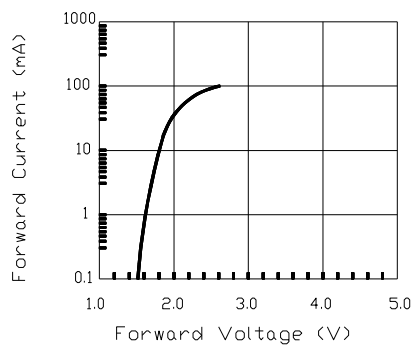

Fig.2 Relative Luminous Intensity vs Forward Current

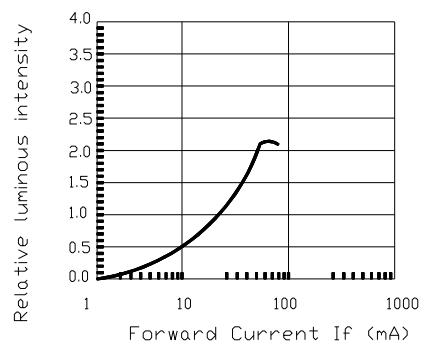

Fig3. Forward Current Derating Curve

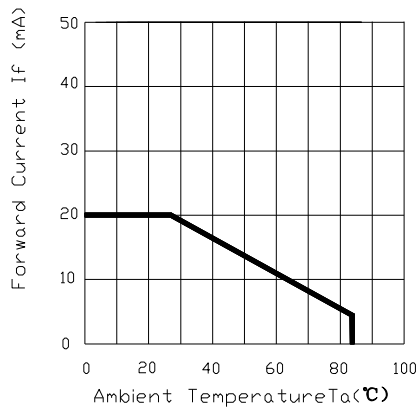

Fig4. Relative Luminous Intensity vs Ambient Temperature

