

Approval Sheet

(產品承認書)

產品名稱 (Product)	<u>Bluetooth Low Energy Module</u>
解決方案 (Solution)	<u>Nordic nRF52810 QFN Package</u>
產品型號 (Model No.)	<u>MDBT42Q – 192KV2 (Chip Antenna)</u> <u>MDBT42Q – P192KV2 (PCB Antenna)</u>
產品料號 (Part No.)	<u>see 4.4 Order Code</u>

Advantage of MDBT42Q & MDBT42Q-P series:

- Long working distance:*
MDBT42Q: over 80 meters in open space.
MDBT42Q-P: up to 60 meters in open space.
- Declaration ID includes all Nordic applied profiles.*
- Granted main regional certification such as FCC (USA), CE(EU)
TELEC (Japan), SRRC (China), IC (Canada), NCC (Taiwan), and KC (South Korea)*

Index

1. Overall Introduction	4
1.1. Application	4
1.2. Features	5
2. Product Dimension	6
2.1. PCB Dimensions & Pin Indication	6
2.2. Recommended Layout of Solder Pad	8
2.3. RF Layout Suggestion (aka Keep-Out Area)	12
2.4. Footprint & Design Guide	14
2.5. Pin Assignment	15
2.6. GPIO Located Near the Radio	17
3. Main Chip Solution	17
4. Shipment Packaging Information	18
4.1. Marking on Metal Shield	19
4.2. Color of Solder Mask and Dot Marking	19
4.3. Packaging Info	20
4.4. Order Code	22
5. Specification	23
5.1. Absolute Maximum Ratings	23
5.2. Operation Conditions	23
5.3. Electrical Specifications	24
6. Block Diagram	29
7. Antenna	30
7.1. MDBT42Q Series	30
7.2. MDBT42Q-P Series	31
8. Reference Circuit	32
9. Certification	33
9.1. Declaration ID	33
9.2. FCC Certificate (USA)	35
9.3. TELEC Certification (Japan)	37
9.4. NCC Certificate (Taiwan)	39
9.5. CE Test Report (EU)	41
9.6. IC Certificate (Canada)	43

9.7. SRRC Certificate (China).....	45
9.8. KC Certificate (South Korea)	46
9.9. RoHS & REACH Report	47
9.10. End-Product Label.....	47
10. Notes and Cautions.....	49
11. Basic Facts for nRF52 Chip.....	50
12. Useful Links	51
Full List of Raytac’s BLE Modules	52
Release Note	56

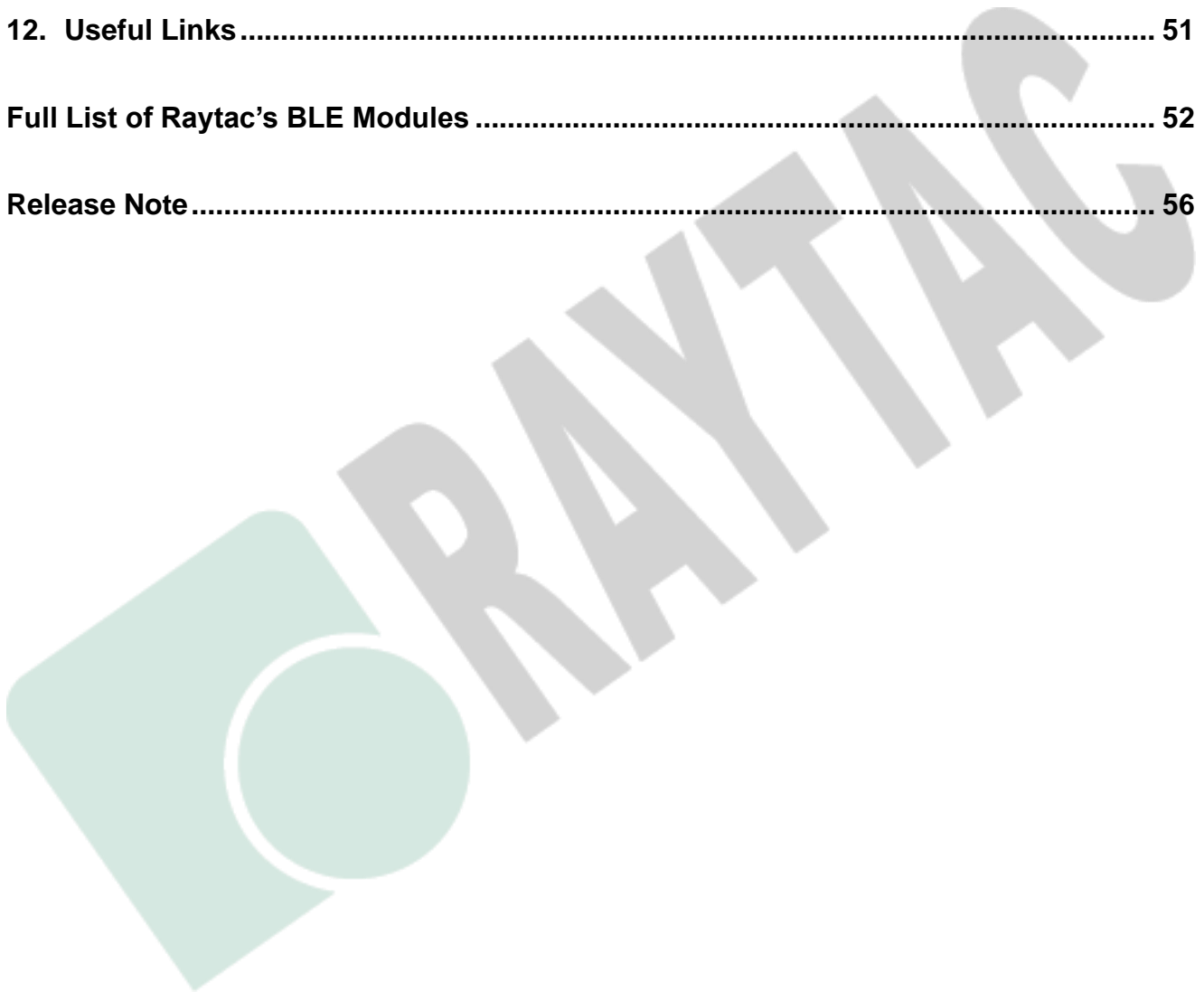

1. Overall Introduction

Raytac's MDBT42Q-192KV2 & MDBT42Q-P192KV2 is a BT 5.2 stack (Bluetooth low energy or BLE) module designed based on **Nordic nRF52810 SoC solution**, which incorporates: **GPIO, SPI, UART, I2C, PWM** and **ADC** interfaces for connecting peripherals and sensors.

Features:

1. Dual Transmission mode of BLE & 2.4Ghz RF upon customer preference.
2. Compact size with **(L) 16 x (W) 10 x (H) 2.2 mm**.
3. Low power requirements, ultra-low peak, average and idle mode power consumption.
4. Be compatible with a large installed base of mobile phones, tablets and computers.
5. Fully coverage of BLE software stack.
6. BLE & RF transmission switching helps products fit all operation system and most hardware.

1.1. Application

- IoT
 - Home automation
 - Sensor networks
 - Building automation
- Personal Area Networks
 - Health / fitness sensor and monitor device
 - Medical devices
 - Key-fobs and wrist watches
- Interactive entertainment devices
 - Remote control
 - Gaming controller
- Beacons
- A4WP wireless chargers and devices
- Remote control toys
- Computer peripherals and I/O devices
 - Mouse
 - Keyboard
 - Multi-touch trackpad

1.2. Features

- Multi-protocol 2.4GHz radio
- 32-bit ARM Cortex – M4 processor
- 192KB flash programmed memory and 24KB RAM
- Software stacks available as downloads
- Application development independent from protocol stack
- On-air compatible with nRF51, nRF24AP and nRF24L series
- Programmable output power from +4dBm to -20dBm
- RSSI
- RAM mapped FIFOs using EasyDMA
- Flexible and configurable 32 pin GPIO
- Programmable peripheral interface - PPI
- Simple ON / OFF global power mode
- Full set of digital interface all with Easy DMA including:
 - 1 x Hardware SPI master ; 1 x Hardware SPI slave
 - 1 x two-wire master ; 1 x two-wire slave
 - 1 x UART (CTS / RTS)
 - PDM for digital microphone
- Quadrature demodulator
- 12-bit / 200KSPS ADC
- 128-bit AES ECB / CCM / AAR co-processor
- Low cost external crystal 32MHz \pm 40ppm for Bluetooth ; \pm 50ppm for ANT Plus
- Low power 32MHz crystal and RC oscillators
- Wide supply voltage range 1.7V to 3.6V
- On-chip DC/DC buck converter
- Individual power management for all peripherals
- Timer counter
 - 3x 32-bit
 - 2 x 24-bit RTC
- 4-channel pulse width modulator (PWM) unit with EasyDMA

2. Product Dimension

2.1. PCB Dimensions & Pin Indication

- **MDBT42Q**

PCB Size (in mm)			
	Min.	Norm	MAX.
L		16	
W	- 0.15	10	+ 0.2
H		2.2	

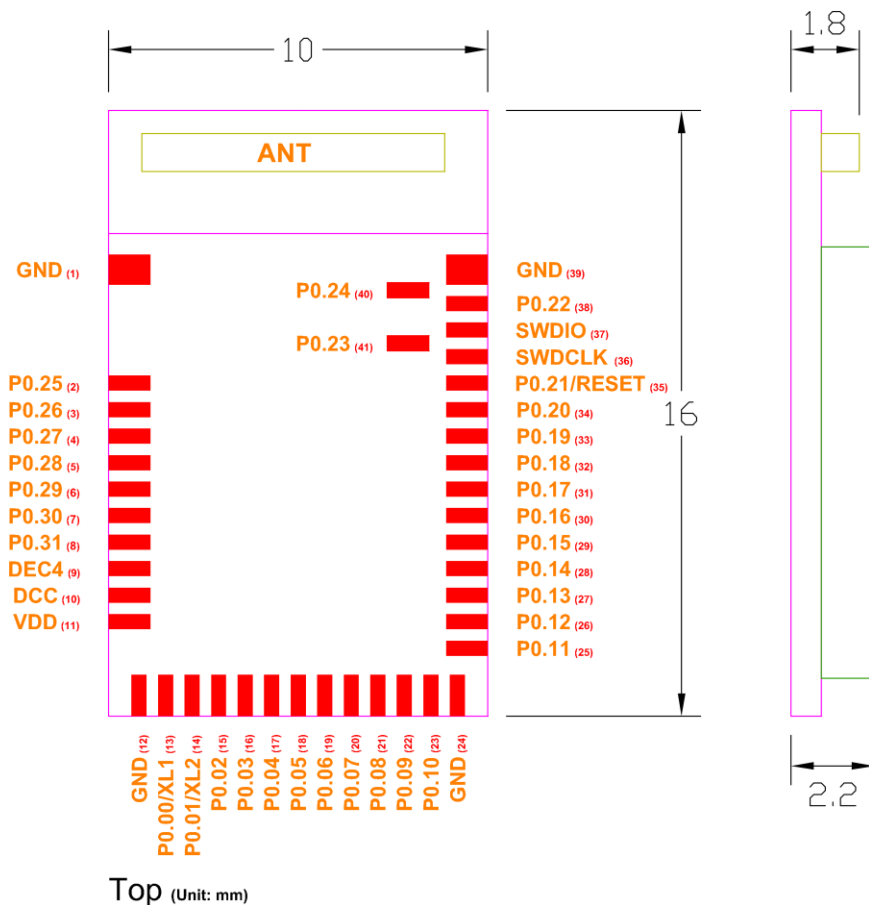

*** Please be careful of the amount of solder paste for P0.23 & P0.24. The module may be lifted due to excess solder. Pads for P0.23 & P0.24 can be omitted when two GPIOs were not used.**

• **MDBT42Q-P**

PCB Size (in mm)			
	Min.	Norm	MAX.
L		16	
W	- 0.15	10	+ 0.2
H		2.2	

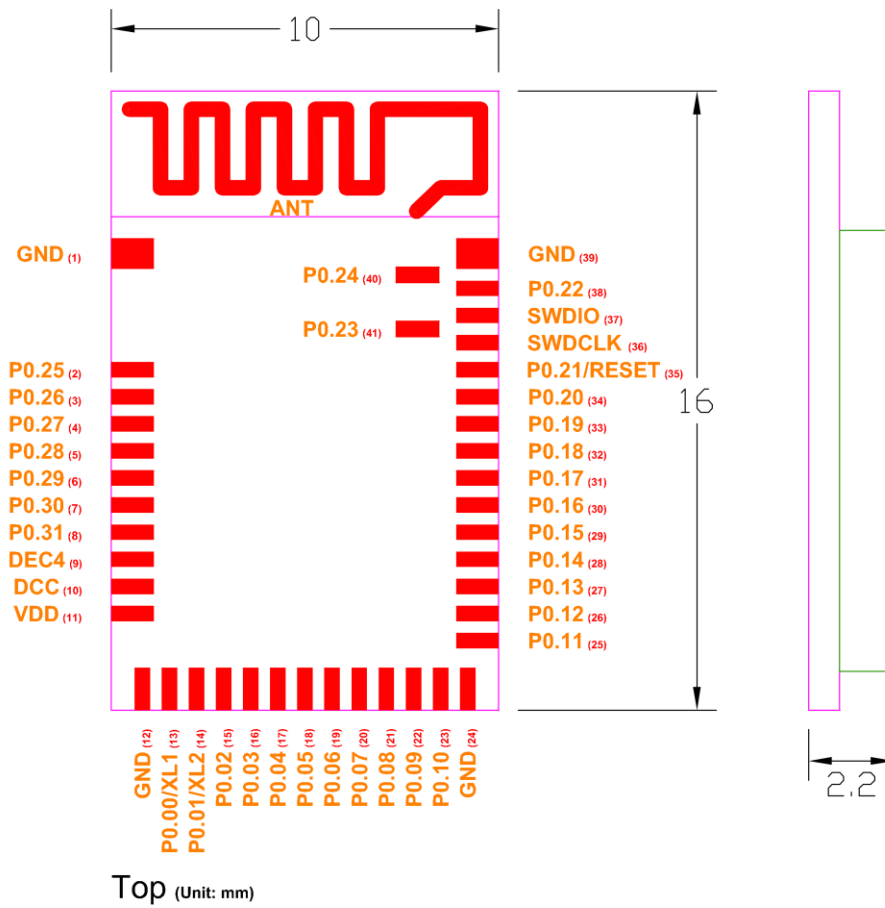

*** Please be careful of the amount of solder paste for P0.23 & P0.24. The module may be lifted due to excess solder. Pads for P0.23 & P0.24 can be omitted when two GPIOs were not used.**

2.2. Recommended Layout of Solder Pad

Graphs are all in Top View, Unit in mm.

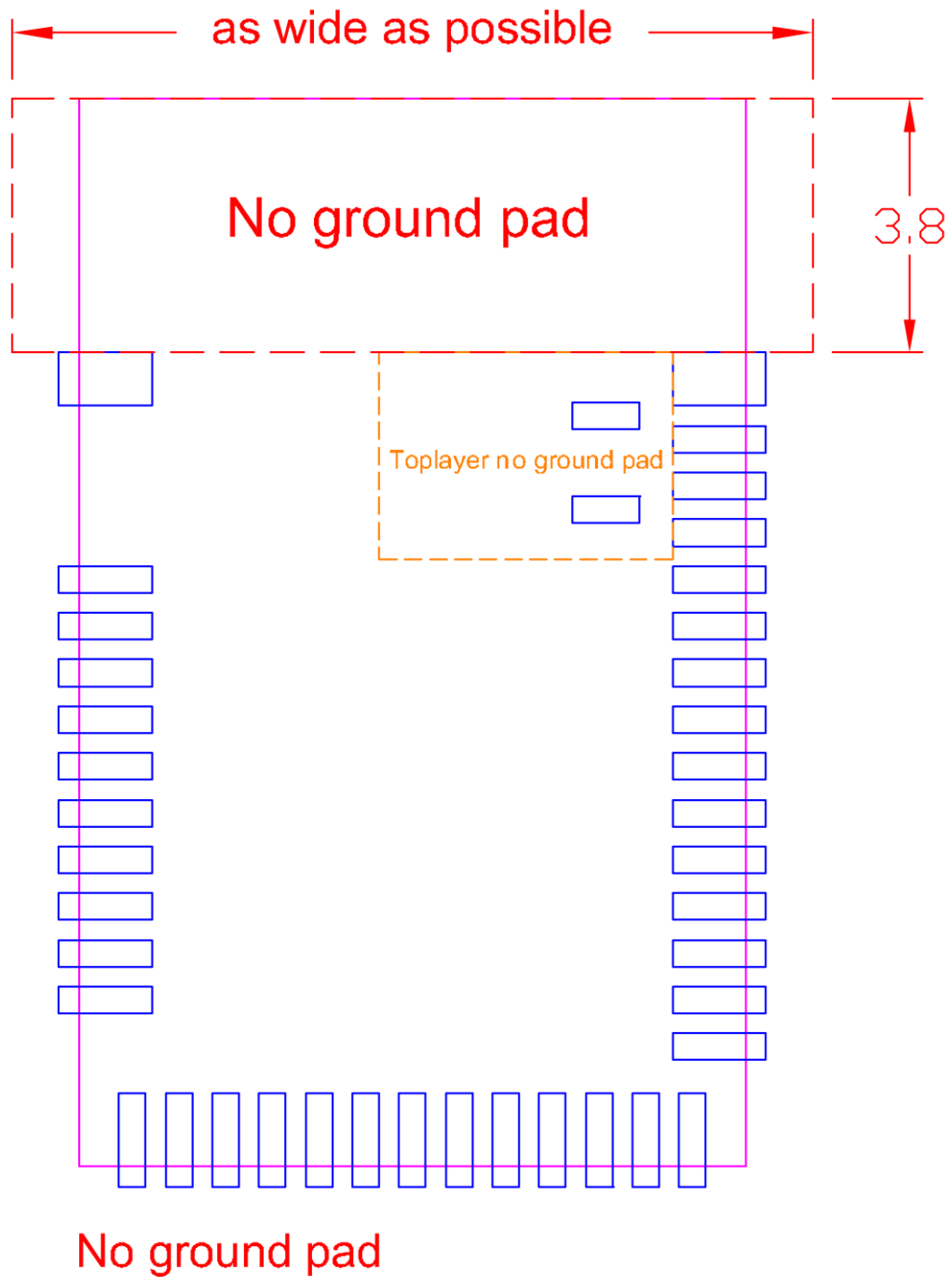

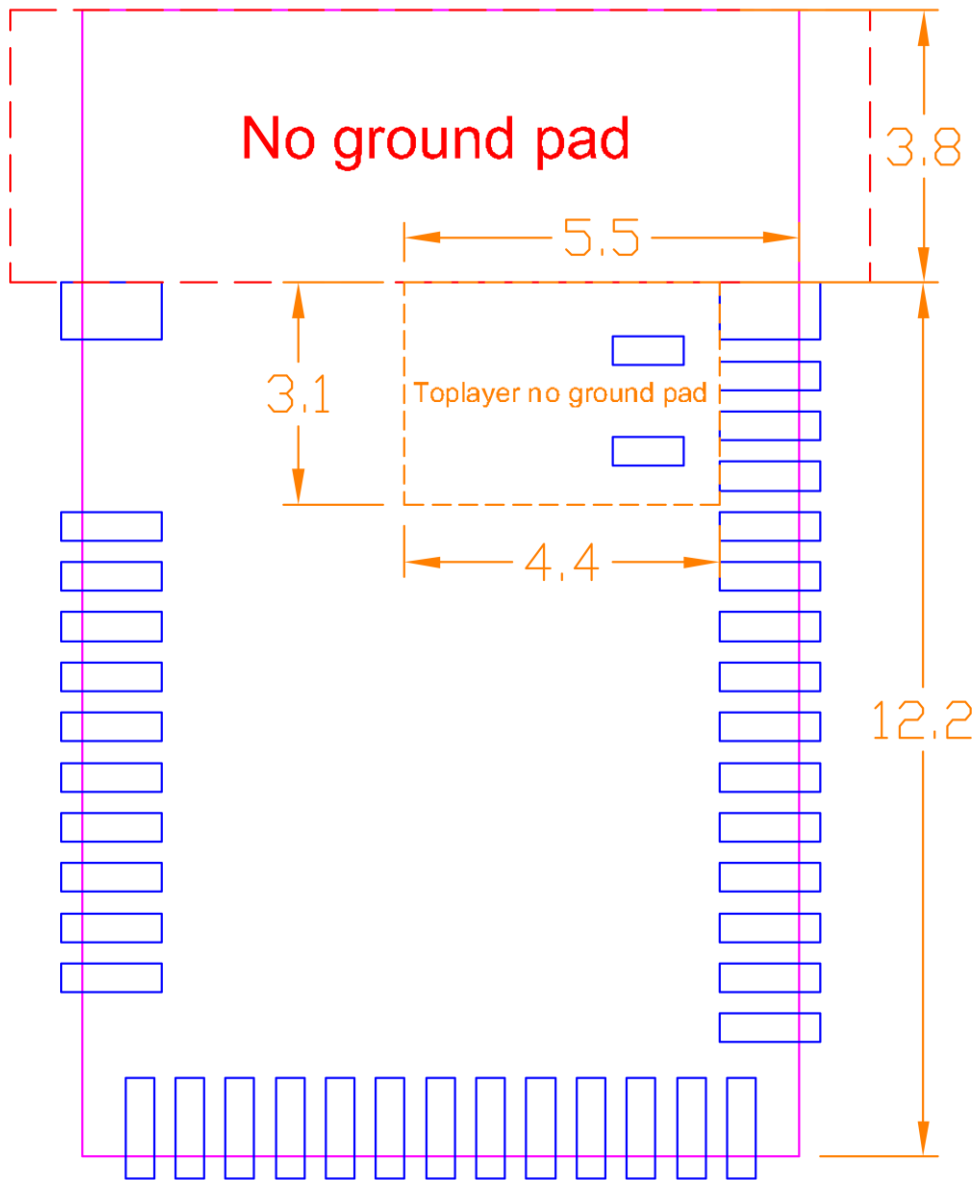

No ground pad

3,8

5,5

3,1

Toplayer no ground pad

4,4

12,2

Toplayer no ground pad

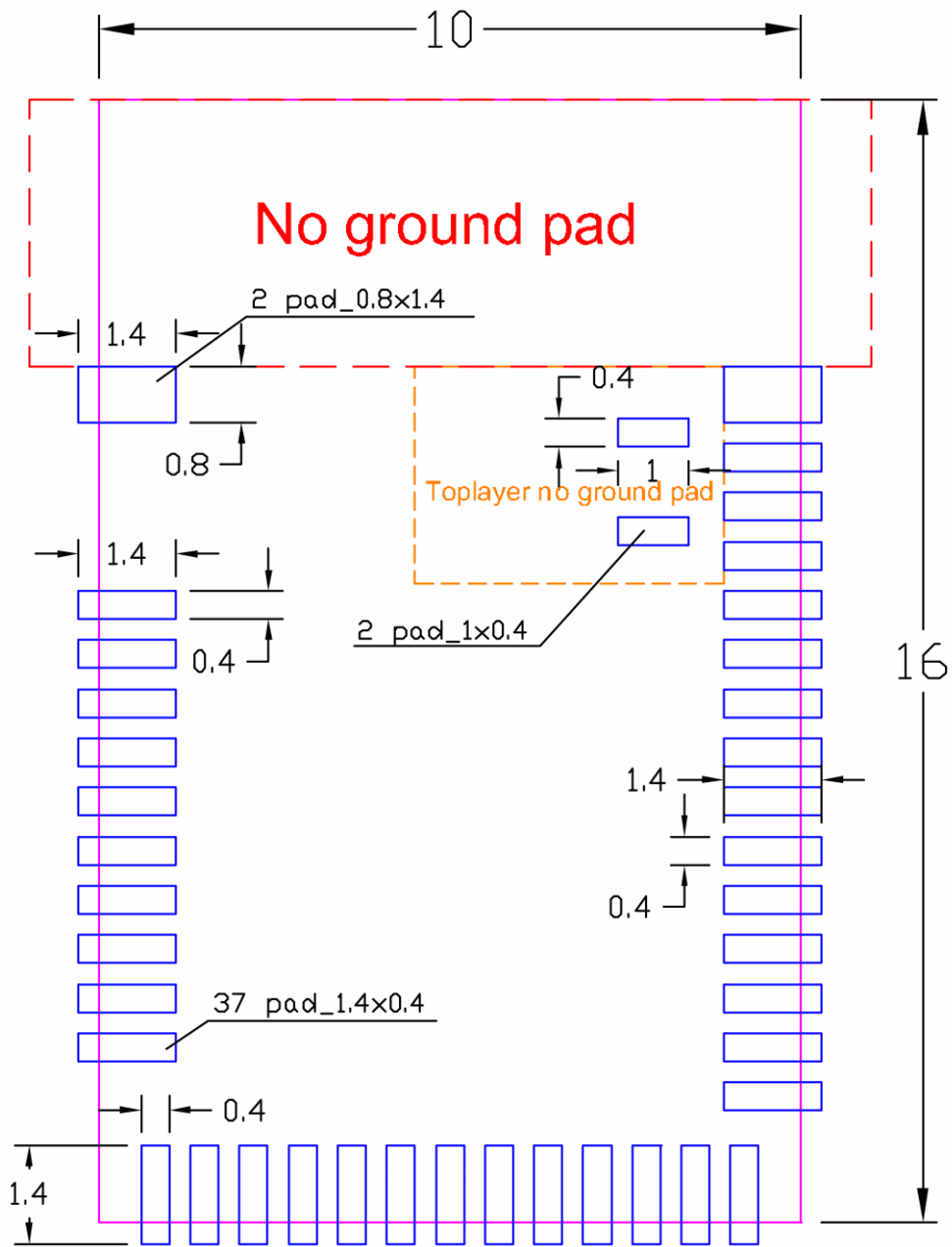

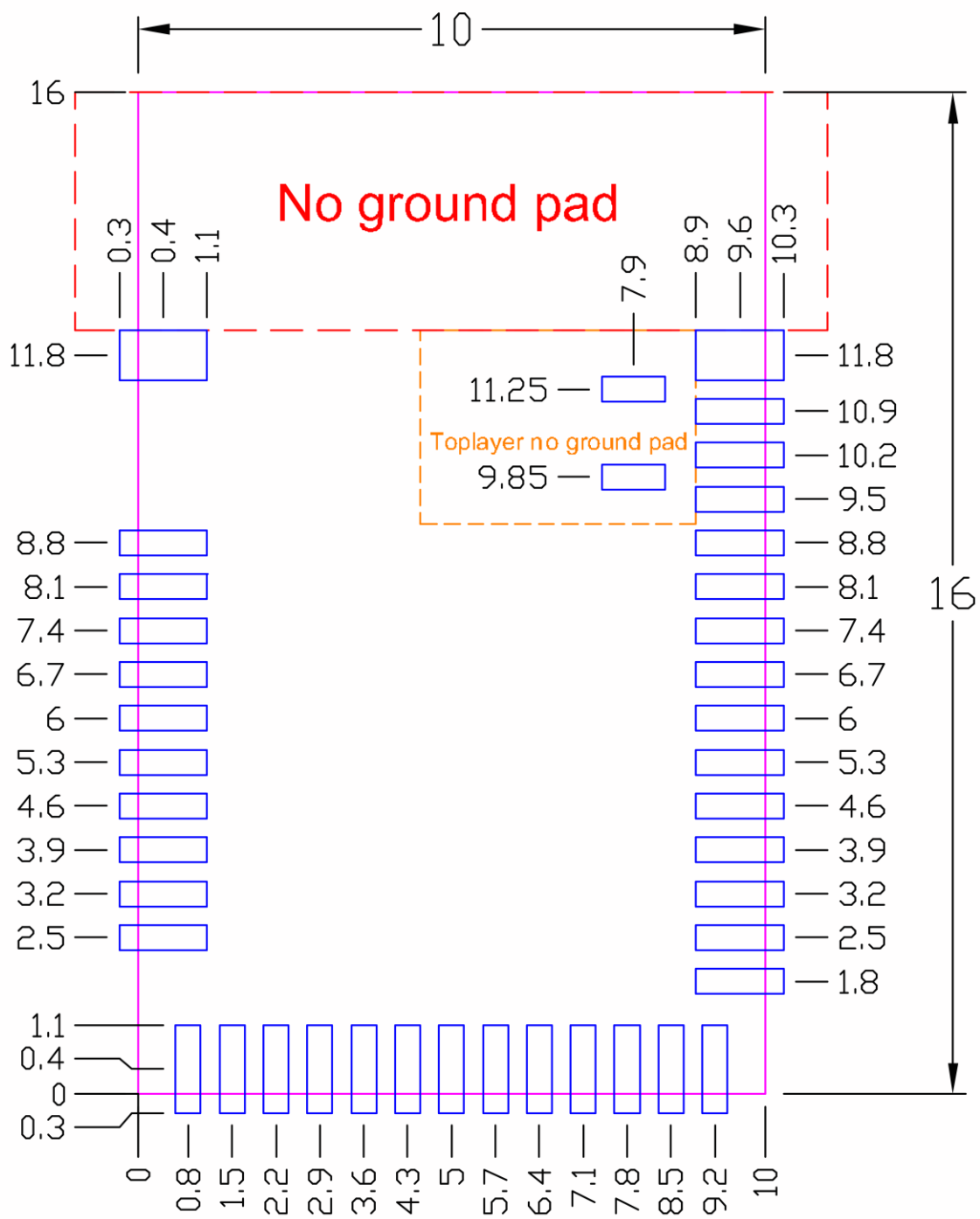

Top View (Unit : mm)
recommended solder pad layout

2.3. RF Layout Suggestion (aka Keep-Out Area)

Make sure to keep the “No Ground Pad” as wider as you can regardless of the size of your PCB.

No-Ground Pad should be included in the corresponding position of the antenna in **EACH LAYER**.

Place the module towards the edge of PCB to have better performance than placing it on the center.

Welcome to send us your layout in PDF for review at service@raytac.com or your contact at Raytac with title “Layout reviewing –Raytac model no.–YOUR company’s name”.

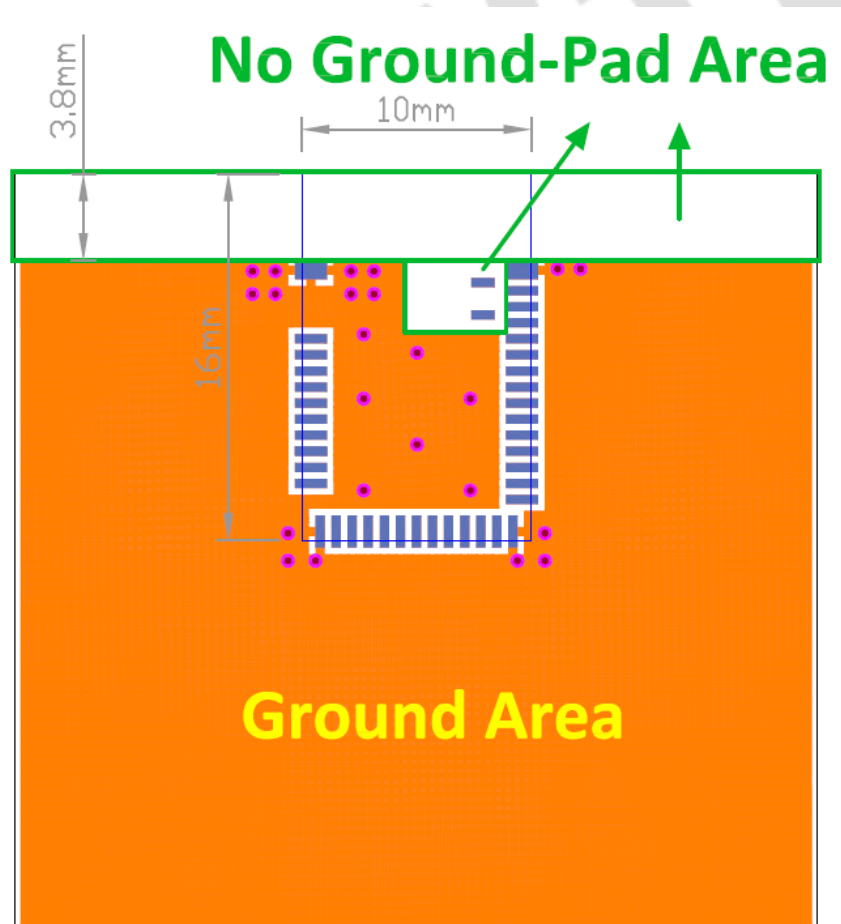

Top layer

Please add via holes in GROUND area as many as possible, especially around the four corners.

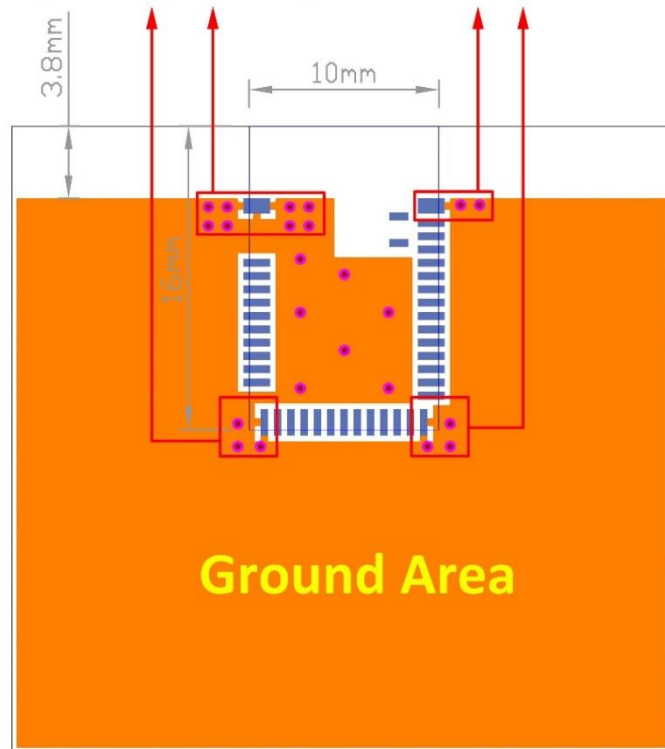

Top layer

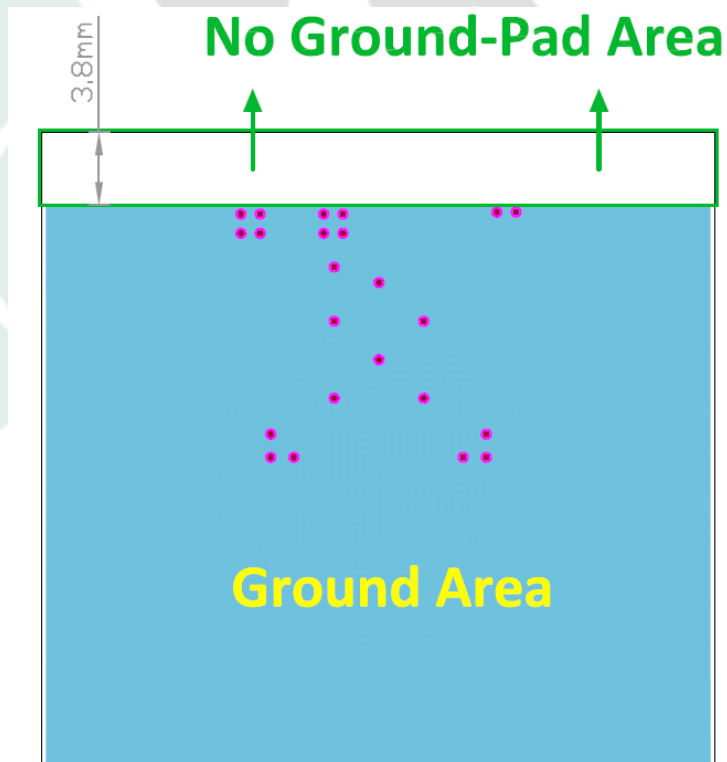

Bottom layer

Examples of “**NOT RECOMMENDED**” layout

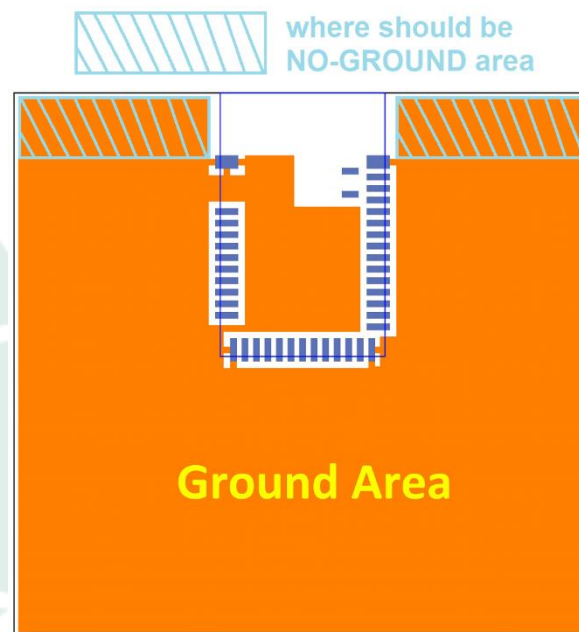
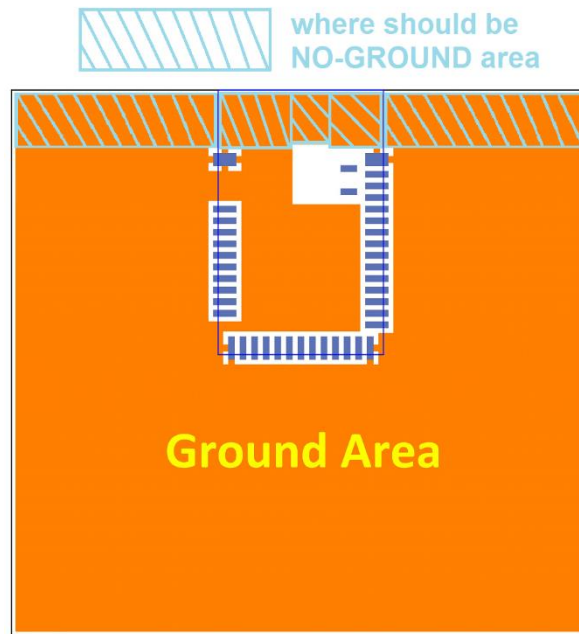

2.4. Footprint & Design Guide

Please visit “[Support](#)” page of our website to download. The package includes footprint, 2D/3D drawing, reflow graph and recommended spec for external 32.768khz.

2.5. Pin Assignment

Pin No.	Name	Pin function	Description
(1)	GND	Ground	The pad must be connected to a solid ground plane
(2)	P0.25	Digital I/O	General-purpose digital I/O
(3)	P0.26	Digital I/O	General-purpose digital I/O
(4)	P0.27	Digital I/O	General-purpose digital I/O
(5)	P0.28	Digital I/O	General-purpose digital I/O
	AIN4	Analog input	SAADC/COMP/LPCOMP input
(6)	P0.29	Digital I/O	General-purpose digital I/O
	AIN5	Analog input	SAADC/COMP/LPCOMP input
(7)	P0.30	Digital I/O	General-purpose digital I/O
	AIN6	Analog input	SAADC/COMP/LPCOMP input
(8)	P0.31	Digital I/O	General-purpose digital I/O
	AIN7	Analog input	SAADC/COMP/LPCOMP input
(9)	DEC4	Power	1V3 regulator supply decoupling. Input from DC/DC converter. Output from 1V3 LDO .
(10)	DCC	Power	DC/DC converter output pin
(11)	VDD	Power	Power-supply pin
(12)	GND	Ground	The pad must be connected to a solid ground plane
(13)	P0.00	Digital I/O	General-purpose digital I/O
	XL1	Analog input	Connection to 32.768khz crystal (LFXO)
(14)	P0.01	Digital I/O	General-purpose digital I/O
	XL2	Analog input	Connection to 32.768khz crystal (LFXO)
(15)	P0.02	Digital I/O	General-purpose digital I/O
	AIN0	Analog input	SAADC/COMP/LPCOMP input
(16)	P0.03	Digital I/O	General-purpose digital I/O
	AIN1	Analog input	SAADC/COMP/LPCOMP input
(17)	P0.04	Digital I/O	General-purpose digital I/O
	AIN2	Analog input	SAADC/COMP/LPCOMP input
(18)	P0.05	Digital I/O	General-purpose digital I/O
	AIN3	Analog input	SAADC/COMP/LPCOMP input
(19)	P0.06	Digital I/O	General-purpose digital I/O
(20)	P0.07	Digital I/O	General-purpose digital I/O

Pin No.	Name	Pin function	Description
(21)	P0.08	Digital I/O	General-purpose digital I/O
(22)	P0.09	Digital I/O	General-purpose digital I/O
(23)	P0.10	Digital I/O	General-purpose digital I/O
(24)	GND	Ground	The pad must be connected to a solid ground plane
(25)	P0.11	Digital I/O	General-purpose digital I/O
(26)	P0.12	Digital I/O	General-purpose digital I/O
(27)	P0.13	Digital I/O	General-purpose digital I/O
(28)	P0.14	Digital I/O	General-purpose digital I/O
(29)	P0.15	Digital I/O	General-purpose digital I/O
(30)	P0.16	Digital I/O	General-purpose digital I/O
(31)	P0.17	Digital I/O	General-purpose digital I/O
(32)	P0.18	Digital I/O	General-purpose digital I/O
(33)	P0.19	Digital I/O	General-purpose digital I/O
(34)	P0.20	Digital I/O	General-purpose digital I/O
(35)	P0.21	Digital I/O	General-purpose digital I/O
	RESET		Configurable as system RESET pin
(36)	SWDCLK	Digital input	Serial Wire debug clock input for debug and programming
(37)	SWDIO	Digital I/O	Serial Wire debug I/O for debug and programming
(38)	P0.22	Digital I/O	General-purpose digital I/O
(39)	GND	Ground	The pad must be connected to a solid ground plane
(40)	P0.24	Digital I/O	General-purpose digital I/O
(41)	P0.23	Digital I/O	General-purpose digital I/O

2.6. GPIO Located Near the Radio

Some GPIO have recommended usage. To maximize RF performance, these GPIO are only available to use as **low drive, low frequency I/O only**. Wrong usage may lead to undesirable performance. Here is the list of these GPIO:

Low frequency I/O is a signal with a frequency up to 10 kHz. SPI, I2C, UART, PWM are NOT low frequency I/O.



Module Pin	GPIO
2	P0.25
3	P0.26
4	P0.27
5	P0.28
6	P0.29

3. Main Chip Solution

RF IC	Crystal Frequency
Nordic NRF52810	32MHZ

32MHz crystal is already inside the module.

4. Shipment Packaging Information

Model	Antenna	Photo
MDBT42Q-192KV2	Chip/Ceramic	
MDBT42Q-P192KV2	PCB/Printed	

Revision 2 IC starts deploying from date code 937.

- Unit Weight of Module:

MDBT42Q-192KV2: 0.64g (± 0.02 g) ; MDBT42Q-P192KV2: 0.62g (± 0.02 g)

- Packaging Type: Anti-static tray & Tape & Reel .

	Tray	Tape & Reel
MPQ (Min. Package Q'ty)	88 pcs per tray	1,500 pcs per reel
Carton Contents (per carton)	1,760 pcs	1,500 pcs
Carton Dimension (L) x (W) x (H) cm	37 x 21 x 13	37 x 36 x 6
Gross Weight	about 2.8 kgs	about 1.9 kgs

4.1. Marking on Metal Shield

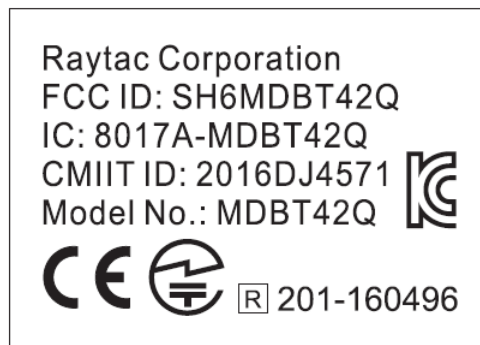

4.2. Color of Solder Mask and Dot Marking

Module(s) with date code “738” would have solder mask (PCB color) in **BLUE with one black dot on the lower right corner of the shielding**. Batches with other date code are all in **GREEN solder mask with no dot marking**.

4.3. Packaging Info

4.3.1. Tray Packaging

Anti-static tray is specifically designed for mass production. It can be used directly on SMT automatic machine.

Before July 1st, 2022

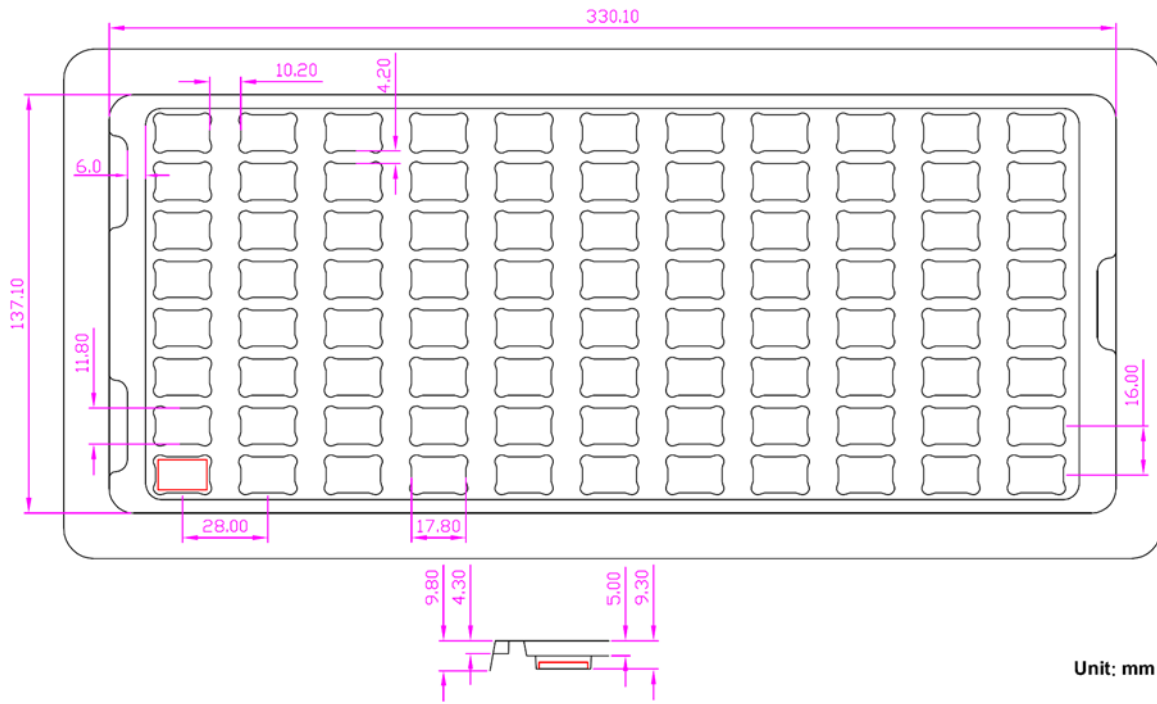

After July 1st, 2022

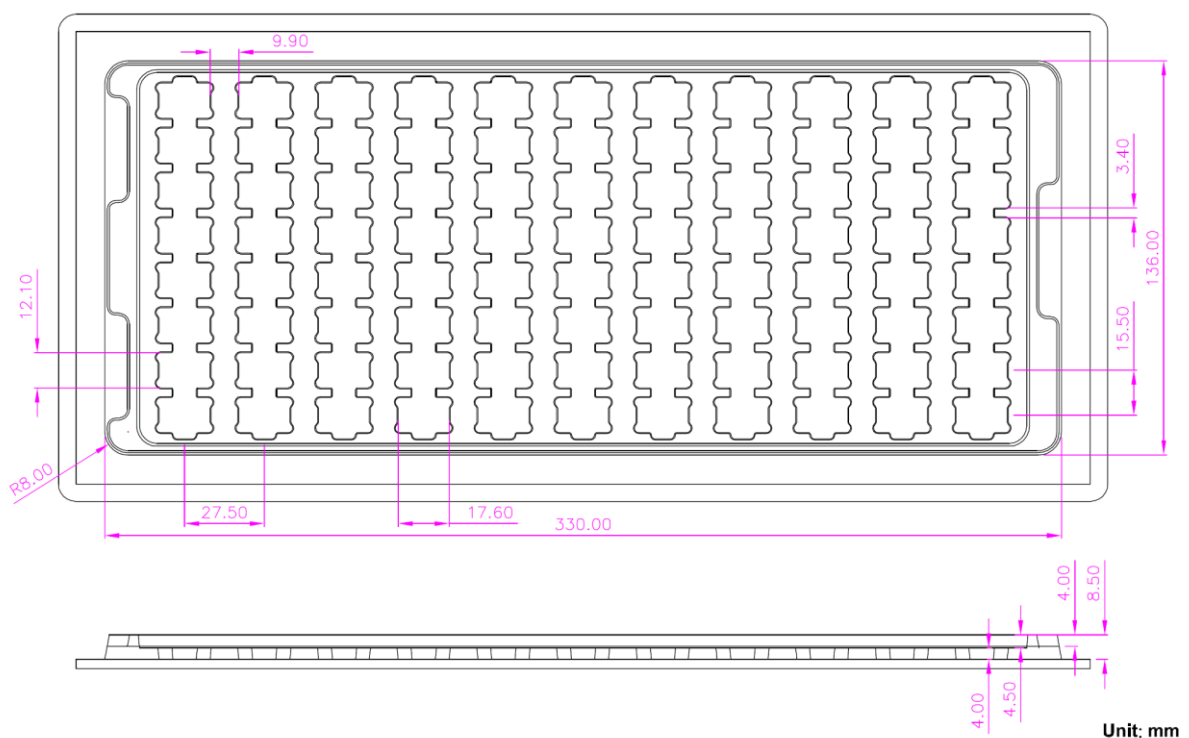

4.3.2. Reel Packaging

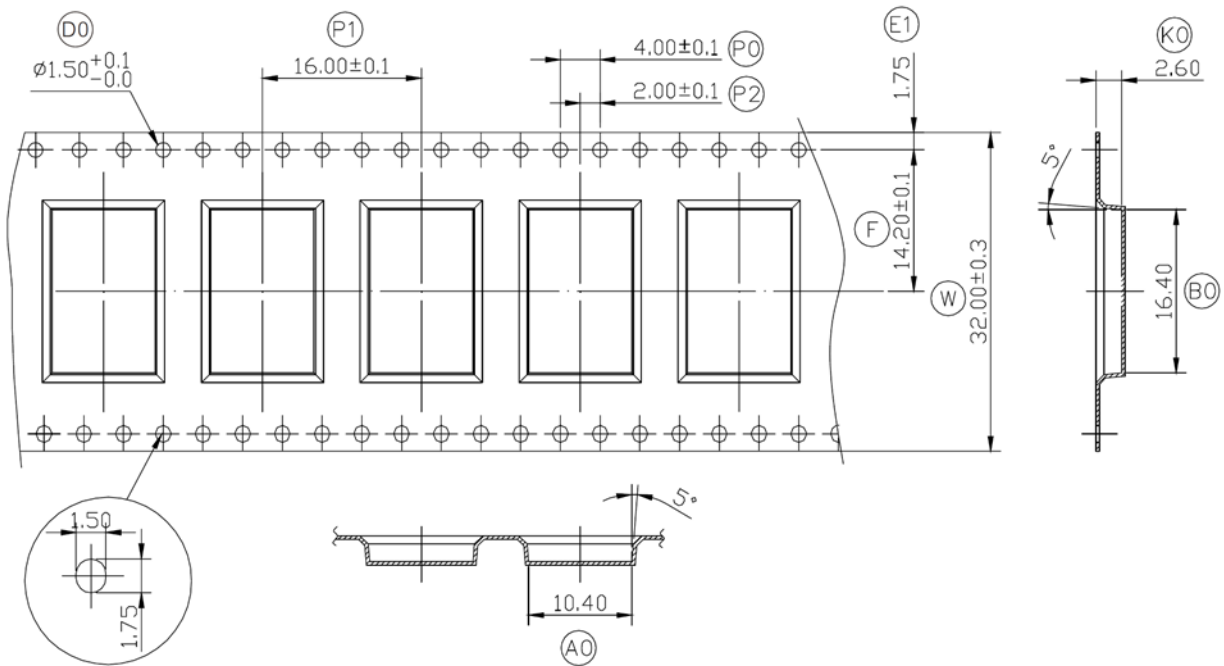

W	32.00	±0.30
P1	16.00	±0.10
E1	1.75	±0.10
F	14.20 ± 0.10	
D0	1.50	+0.1/-0
P0	4.00	±0.10
P2	2.00	±0.10
A0	10.40	±0.10
B0	16.40	±0.10
K0	2.60	±0.10
T	0.30	±0.05

4.4. Order Code

Each model has two options of packaging. Please use following part no. when placing order to us.

Model	Tray	Tape & Reel
MDBT42Q-192KV2	MD-240A2-S65	MD-240A2-S65R
MDBT42Q-P192KV2	MD-240A2-S66	MD-240A2-S66R

MPQ of Reel packaging is 1,500 pcs and Tray packaging is 88 pcs.

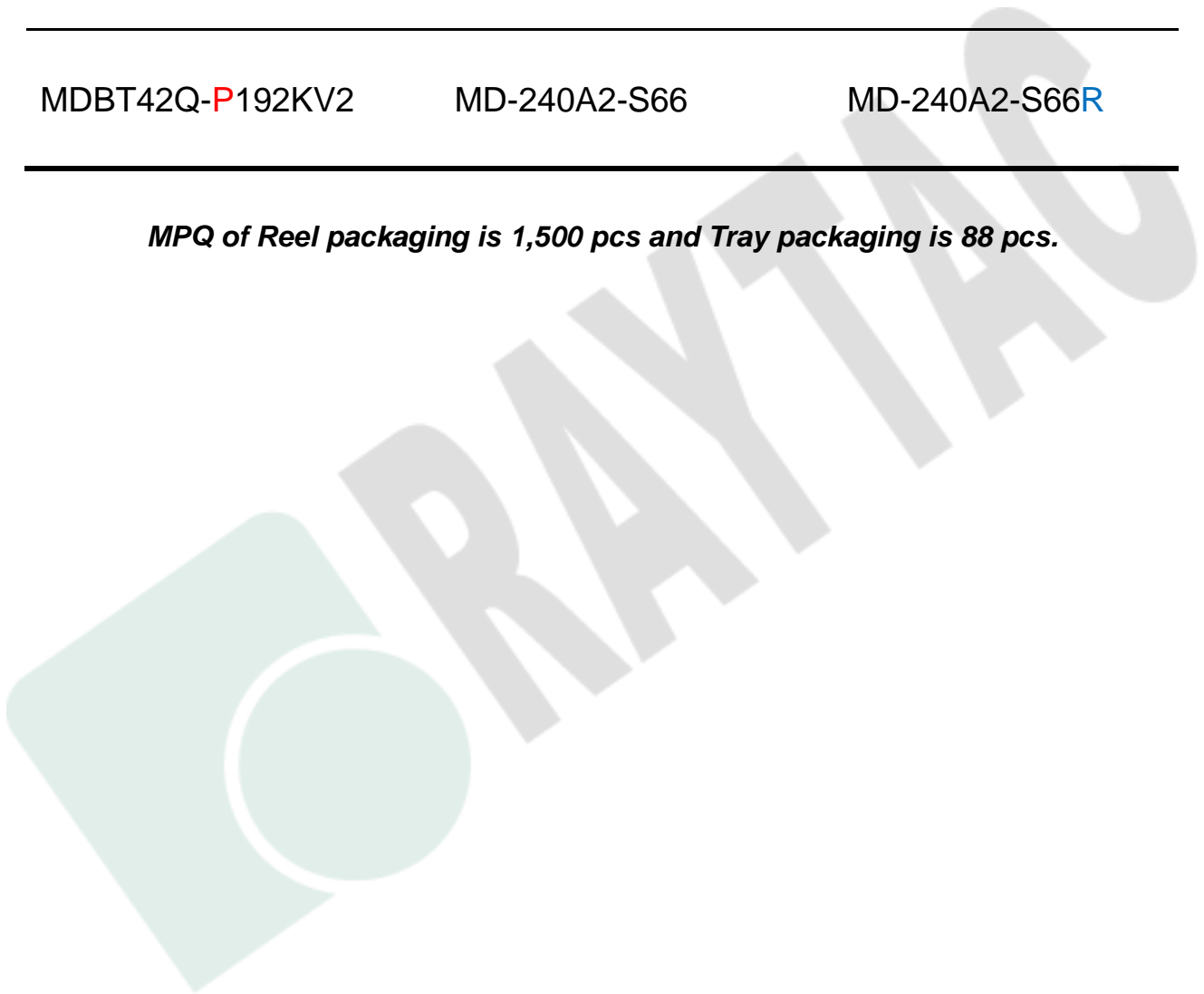

5. Specification

Any technical spec shall refer to Nordic's official documents as final reference. Contents below are from "[nRF52810 Product Specification v1.4](#)", please click to download full spec.

5.1. Absolute Maximum Ratings

	Note	Min.	Max.	Unit
Supply voltages				
VDD		-0.3	+3.9	V
VSS			0	V
I/O pin voltage				
$V_{I/O}$, VDD \leq 3.6 V		-0.3	VDD + 0.3	V
$V_{I/O}$, VDD > 3.6 V		-0.3	3.9	V
Radio				
RF input level			10	dBm
Environmental QFN package				
Storage temperature		-40	+125	°C
MSL	Moisture Sensitivity Level		2	
ESD HBM	Human Body Model		4	kV
ESD HBM Class	Human Body Model Class		3A	
ESD CDM	Charged Device Model		1	kV
Flash memory				
Endurance		10 000		Write/erase cycles
Retention		10 years at 40°C		

5.2. Operation Conditions

Symbol	Parameter	Min.	Nom.	Max.	Units
VDD	Supply voltage, independent of DCDC enable	1.7	3.0	3.6	V
t_{R_VDD}	Supply rise time (0 V to 1.7 V)			60	ms
TA	Operating temperature	-40	25	85	°C

Important: The on-chip power-on reset circuitry may not function properly for rise times longer than the specified maximum.

5.3. Electrical Specifications

5.3.1. General Radio Characteristics

Symbol	Description	Min.	Typ.	Max.	Units
f_{OP}	Operating frequencies	2360		2500	MHz
$f_{PLL,PROG,RES}$	PLL programming resolution		2		kHz
$f_{PLL,CH,SP}$	PLL channel spacing		1		MHz
$f_{DELTA,1M}$	Frequency deviation @ 1 Mbps		± 170		kHz
$f_{DELTA,BLE,1M}$	Frequency deviation @ BLE 1 Mbps		± 250		kHz
$f_{DELTA,2M}$	Frequency deviation @ 2 Mbps		± 320		kHz
$f_{DELTA,BLE,2M}$	Frequency deviation @ BLE 2 Mbps		± 500		kHz
f_{skSPS}	On-the-air data rate	1		2	Mbps

5.3.2. Radio Current Consumption (Transmitter)

Symbol	Description	Min.	Typ.	Max.	Units
$I_{TX,PLUS4dBm,DCDC}$	TX only run current (DCDC, 3V) $P_{RF} = +4$ dBm		7.0		mA
$I_{TX,PLUS4dBm}$	TX only run current $P_{RF} = +4$ dBm		15.4		mA
$I_{TX,0dBm,DCDC}$	TX only run current (DCDC, 3V) $P_{RF} = 0$ dBm		4.6		mA
$I_{TX,0dBm}$	TX only run current $P_{RF} = 0$ dBm		10.1		mA
$I_{TX,MINUS4dBm,DCDC}$	TX only run current DCDC, 3V $P_{RF} = -4$ dBm		3.6		mA
$I_{TX,MINUS4dBm}$	TX only run current $P_{RF} = -4$ dBm		7.8		mA
$I_{TX,MINUS8dBm,DCDC}$	TX only run current DCDC, 3V $P_{RF} = -8$ dBm		3.2		mA
$I_{TX,MINUS8dBm}$	TX only run current $P_{RF} = -8$ dBm		6.8		mA
$I_{TX,MINUS12dBm,DCDC}$	TX only run current DCDC, 3V $P_{RF} = -12$ dBm		2.9		mA
$I_{TX,MINUS12dBm}$	TX only run current $P_{RF} = -12$ dBm		6.2		mA
$I_{TX,MINUS16dBm,DCDC}$	TX only run current DCDC, 3V $P_{RF} = -16$ dBm		2.7		mA
$I_{TX,MINUS16dBm}$	TX only run current $P_{RF} = -16$ dBm		5.7		mA
$I_{TX,MINUS20dBm,DCDC}$	TX only run current DCDC, 3V $P_{RF} = -20$ dBm		2.5		mA
$I_{TX,MINUS20dBm}$	TX only run current $P_{RF} = -20$ dBm		5.4		mA
$I_{TX,MINUS40dBm,DCDC}$	TX only run current DCDC, 3V $P_{RF} = -40$ dBm		2.1		mA
$I_{TX,MINUS40dBm}$	TX only run current $P_{RF} = -40$ dBm		4.3		mA

5.3.3. Radio Current Consumption (Receiver)

Symbol	Description	Min.	Typ.	Max.	Units
I _{RX,1M,DCDC}	RX only run current (DCDC, 3V) 1 Mbps / 1 Mbps BLE		4.6		mA
I _{RX,1M}	RX only run current 1 Mbps / 1 Mbps BLE		10.0		mA
I _{RX,2M,DCDC}	RX only run current (DCDC, 3V) 2 Mbps / 2 Mbps BLE		5.2		mA
I _{RX,2M}	RX only run current 2 Mbps / 2 Mbps BLE		11.2		mA
I _{START,RX,1M,DCDC}	RX start-up current (DCDC, 3 V) 1 Mbps / 1 Mbps BLE		3.5		mA
I _{START,RX,1M}	RX start-up current 1 Mbps / 1 Mbps BLE		6.7		mA

5.3.4. Transmitter Specification

Symbol	Description	Min.	Typ.	Max.	Units
P _{RF}	Maximum output power		4	8	dBm
P _{RFC}	RF power control range		24		dB
P _{RFCR}	RF power accuracy			±4	dB
P _{RF1,1}	1st Adjacent Channel Transmit Power 1 MHz (1 Mbps)		-25		dBc
P _{RF2,1}	2nd Adjacent Channel Transmit Power 2 MHz (1 Mbps)		-50		dBc
P _{RF1,2}	1st Adjacent Channel Transmit Power 2 MHz (2 Mbps)		-25		dBc
P _{RF2,2}	2nd Adjacent Channel Transmit Power 4 MHz (2 Mbps)		-50		dBc

5.3.5. Receiver Operation

Symbol	Description	Min.	Typ.	Max.	Units
P _{RX,MAX}	Maximum received signal strength at < 0.1% BER		0		dBm
P _{SENS,IT,1M}	Sensitivity, 1 Mbps nRF mode ¹		-93		dBm
P _{SENS,IT,SP,1M,BLE}	Sensitivity, 1 Mbps BLE ideal transmitter, <=37 bytes BER=1E-3 ²		-96		dBm
P _{SENS,IT,LP,1M,BLE}	Sensitivity, 1 Mbps BLE ideal transmitter >=128 bytes BER=1E-4 ³		-95		dBm
P _{SENS,IT,2M}	Sensitivity, 2 Mbps nRF mode ⁴		-89		dBm
P _{SENS,IT,SP,2M,BLE}	Sensitivity, 2 Mbps BLE ideal transmitter, Packet length <=37bytes		-93		dBm

1. Typical sensitivity applies when ADDR0 is used for receiver address correlation. When ADDR [1...7] are used for receiver address correlation, the typical sensitivity for this mode is degraded by 3dB.
2. As defined in the Bluetooth Core Specification v4.0 Volume 6: Core System Package (Low Energy Controller Volume).
3. Equivalent BER limit < 10E-04.
4. Same as remark 1.

5.3.6. RX Selectivity

Symbol	Description	Min.	Typ.	Max.	Units
$C/I_{1M,co-channel}$	1 Mbps mode, Co-Channel interference		9		dB
$C/I_{1M,-1MHz}$	1 Mbps mode, Adjacent (-1 MHz) interference		-2		dB
$C/I_{1M,+1MHz}$	1 Mbps mode, Adjacent (+1 MHz) interference		-10		dB
$C/I_{1M,-2MHz}$	1 Mbps mode, Adjacent (-2 MHz) interference		-19		dB
$C/I_{1M,+2MHz}$	1 Mbps mode, Adjacent (+2 MHz) interference		-42		dB
$C/I_{1M,-3MHz}$	1 Mbps mode, Adjacent (-3 MHz) interference		-38		dB
$C/I_{1M,+3MHz}$	1 Mbps mode, Adjacent (+3 MHz) interference		-48		dB
$C/I_{1M,\pm 6MHz}$	1 Mbps mode, Adjacent (≥ 6 MHz) interference		-50		dB
$C/I_{1MBLE,co-channel}$	1 Mbps BLE mode, Co-Channel interference		6		dB
$C/I_{1MBLE,-1MHz}$	1 Mbps BLE mode, Adjacent (-1 MHz) interference		-2		dB
$C/I_{1MBLE,+1MHz}$	1 Mbps BLE mode, Adjacent (+1 MHz) interference		-9		dB
$C/I_{1MBLE,-2MHz}$	1 Mbps BLE mode, Adjacent (-2 MHz) interference		-22		dB
$C/I_{1MBLE,+2MHz}$	1 Mbps BLE mode, Adjacent (+2 MHz) interference		-46		dB
$C/I_{1MBLE,>3MHz}$	1 Mbps BLE mode, Adjacent (≥ 3 MHz) interference		-50		dB
$C/I_{1MBLE,image}$	Image frequency Interference		-22		dB
$C/I_{1MBLE,image,1MHz}$	Adjacent (1 MHz) interference to in-band image frequency		-35		dB
$C/I_{2M,co-channel}$	2 Mbps mode, Co-Channel interference		10		dB
$C/I_{2M,-2MHz}$	2 Mbps mode, Adjacent (-2 MHz) interference		6		dB
$C/I_{2M,+2MHz}$	2 Mbps mode, Adjacent (+2 MHz) interference		-14		dB
$C/I_{2M,-4MHz}$	2 Mbps mode, Adjacent (-4 MHz) interference		-20		dB
$C/I_{2M,+4MHz}$	2 Mbps mode, Adjacent (+4 MHz) interference		-44		dB
$C/I_{2M,-6MHz}$	2 Mbps mode, Adjacent (-6 MHz) interference		-42		dB
$C/I_{2M,+6MHz}$	2 Mbps mode, Adjacent (+6 MHz) interference		-47		dB
$C/I_{2M,\geq 12MHz}$	2 Mbps mode, Adjacent (≥ 12 MHz) interference		-52		dB

Remark: Wanted signal level at PIN = -67 dBm. One interferer is used, having equal modulation as the wanted signal. The input power of the interferer where the sensitivity equals BER = 0.1% is presented.

5.3.7. RX Intermodulation

Symbol	Description	Min.	Typ.	Max.	Units
P _{IMD,5TH,1M}	IMD performance, 1 Msps, 5th offset channel, Packet length <= 37 bytes		-33		dBm
P _{IMD,5TH,1M,BLE}	IMD performance, BLE 1 Msps, 5th offset channel, Packet length <= 37 bytes		-30		dBm
P _{IMD,5TH,2M}	IMD performance, 2 Msps, 5th offset channel, Packet length <= 37 bytes		-33		dBm
P _{IMD,5TH,2M,BLE}	IMD performance, BLE 2 Msps, 5th offset channel, Packet length <= 37 bytes		-31		dBm

Remark: Wanted signal level at PIN = -64dBm. Two interferers with equal input power are used. The interferer closest in frequency is not modulated, the other interferer is modulated equal with the wanted signal. The input power of the interferers where the sensitivity equals BER = 0.1% is presented.

5.3.8. Radio Timing Parameters

Symbol	Description	Min.	Typ.	Max.	Units
t _{TXEN}	Time between TXEN task and READY event after channel FREQUENCY configured. Compatible with old devices.	140		140	μs
t _{TXEN,FAST}	Time between TXEN task and READY event after channel FREQUENCY configured (Fast Mode)	40		40	μs
t _{TXDISABLE,1M}	Time between DISABLE task and DISABLED event when the radio was in TX for MODE = Nrf_1Mbit and MODE = Ble_1Mbit	6		6	μs
t _{TXDISABLE,2M}	Time between DISABLE task and DISABLED event when the radio was in TX and mode is set to 2 Mbps	4		4	μs
t _{RXEN}	Time between the RXEN task and READY event after channel FREQUENCY configured in default mode. Compatible with old devices.	140		140	μs
t _{RXEN,FAST}	Time between the RXEN task and READY event after channel FREQUENCY configured in fast mode	40		40	μs
t _{SWITCH}	The minimum time taken to switch from RX to TX or TX to RX when channel FREQUENCY unchanged		20		μs
t _{RXDISABLE}	Time between DISABLE task and DISABLED event when the radio was in RX	0		0	μs
t _{TXCHAIN}	Digital propagation delay (in radio only) when transmitting. Does not include EasyDMA access time.		0.6		μs
t _{RXCHAIN}	Digital propagation delay (in radio only) when receiving. Does not include EasyDMA access time.		9.4		μs
t _{RXCHAIN,2M}	Digital propagation delay in 2 Mbps mode (radio only) when receiving. Does not include EasyDMA access time.		5		μs

5.3.9. RSSI Specifications

Symbol	Description	Min.	Typ.	Max.	Units
RSSI _{ACC}	RSSI Accuracy Valid range -90 to -20 dBm		±2		dB
RSSI _{RESOLUTION}	RSSI resolution		1		dB
RSSI _{PERIOD}	Sample period		0.25		us

5.3.10. CPU

Symbol	Description	Min.	Typ.	Max.	Units
W _{FLASH}	CPU wait states, running from flash	0		2	
W _{RAM}	CPU wait states, running from RAM			0	
CM _{FLASH}	CoreMark ¹ , running from flash		144		CoreMark
CM _{FLASH/MHz}	CoreMark per MHz, running from flash		2.25		CoreI MHz
CM _{FLASH/ma}	CoreMark per mA, running from flash, DCDC 3V		65		CoreMark/mA

5.3.11. Power Management

Symbol	Description	Min.	Typ.	Max.	Units
I _{ON_RAMOFF_EVENT}	System ON, No RAM retention, Wake on any event		0.6		μA
I _{ON_RAMON_EVENT}	System ON, Full 24 kB RAM retention, Wake on any event		0.8		μA
I _{ON_RAMON_POF}	System ON, Full 24 kB RAM retention, Wake on any event, Power fail comparator enabled		0.8		μA
I _{ON_RAMON_GPIOTE}	System ON, Full 24 kB RAM retention, Wake on GPIOTE input (Event mode)		3.3		μA
I _{ON_RAMON_GPIOTEPORT}	System ON, Full 24 kB RAM retention, Wake on GPIOTE PORT event		0.8		μA
I _{ON_RAMON_RTC}	System ON, Full 24 kB RAM retention, Wake on RTC (running from LFRC clock)		1.5		μA
I _{ON_RAMOFF_RTC}	System ON, No RAM retention, Wake on RTC (running from LFRC clock)		1.4		μA
I _{ON_RAMON_RTC_LFXO}	System ON, Full 24 kB RAM retention, Wake on RTC (running from LFXO clock)		1.1		μA
I _{ON_RAMOFF_RTC_LFXO}	System ON, No RAM retention, Wake on RTC (running from LFXO clock)		1.0		μA
I _{OFF_RAMOFF_RESET}	System OFF, No RAM retention, Wake on reset		0.3		μA
I _{OFF_RAMON_RESET}	System OFF, Full 24 kB RAM retention, Wake on reset		0.5		μA

6. Block Diagram

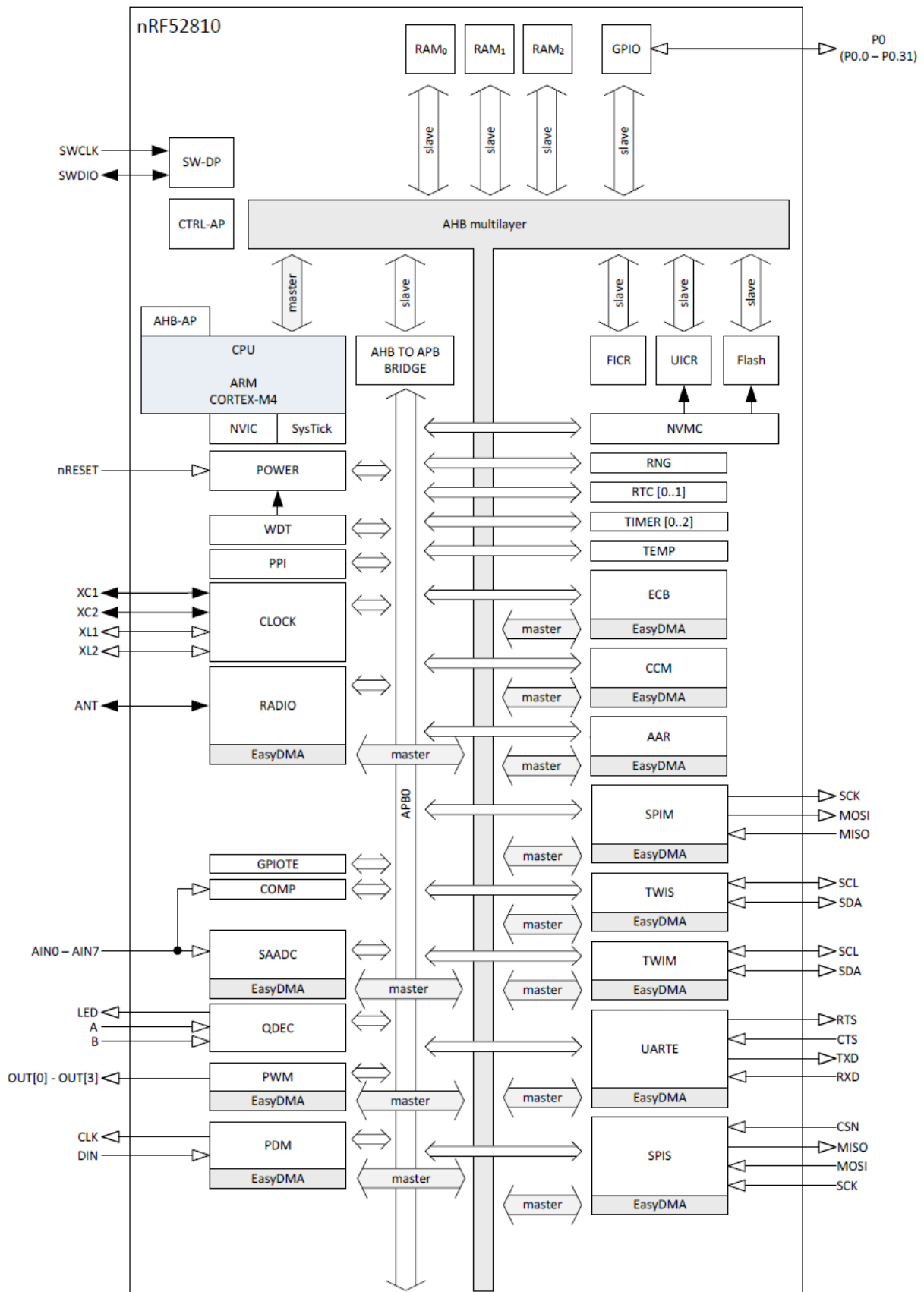

7. Antenna

7.1. MDBT42Q Series

Test Result

Frequency (MHz)	2400	2410	2420	2430	2440	2450	2460	2470	2480	2490	2500
Gain (dBi)	-3.68	-2.91	-2.34	-1.98	-1.66	-1.60	-1.77	-2.09	-2.60	-3.35	-4.10
Peak EIRP (dBm)	-3.68	-2.91	-2.34	-1.98	-1.66	-1.60	-1.77	-2.09	-2.60	-3.35	-4.10
Directivity (dBi)	4.98	5.11	5.12	5.02	4.93	4.76	4.58	4.38	4.11	3.77	3.42

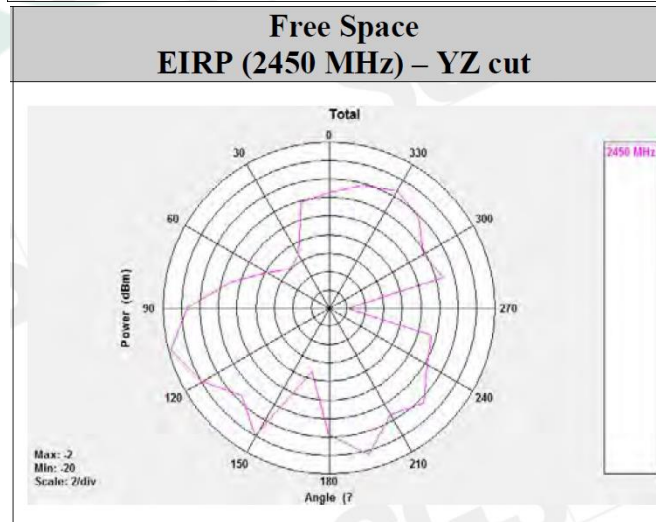
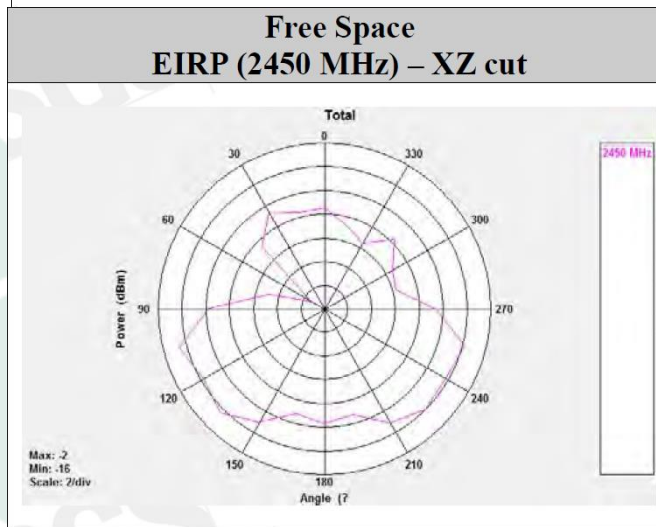
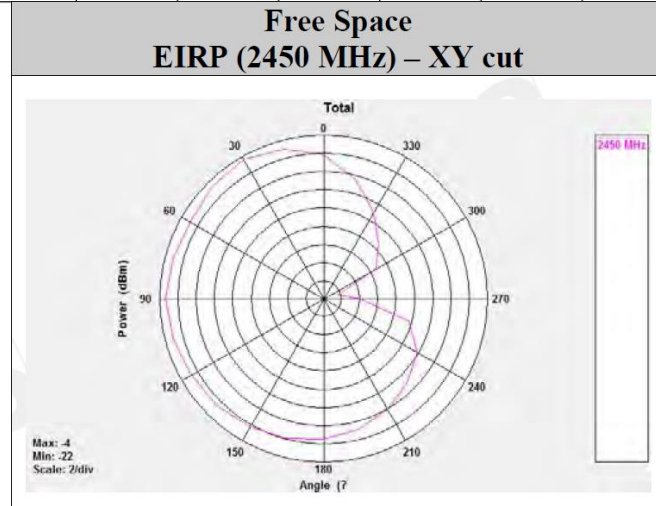

7.2. MDBT42Q-P Series

Test Result

Frequency (MHz)	2400	2410	2420	2430	2440	2450	2460	2470	2480	2490	2500
Gain (dBi)	-3.87	-3.06	-2.31	-2.01	-2.04	-2.31	-2.24	-1.96	-1.61	-1.71	-1.97
Peak EIRP (dBm)	-3.87	-3.06	-2.31	-2.01	-2.04	-2.31	-2.24	-1.96	-1.61	-1.71	-1.97
Directivity (dBi)	3.79	4.00	4.25	4.17	3.86	3.51	3.54	3.91	4.39	4.44	4.49

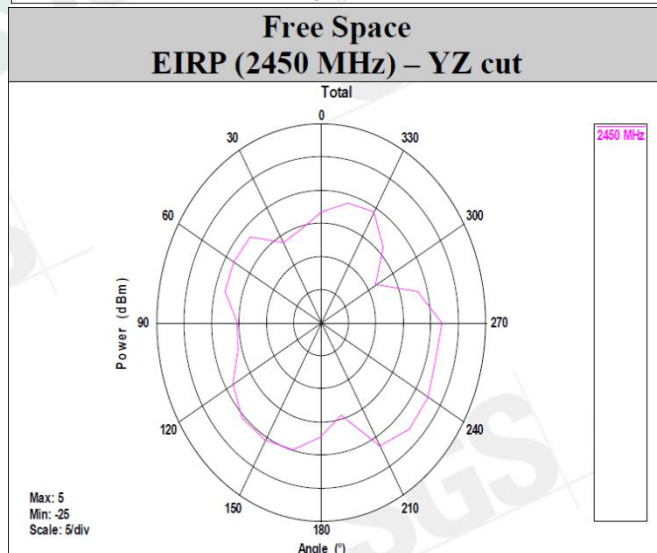
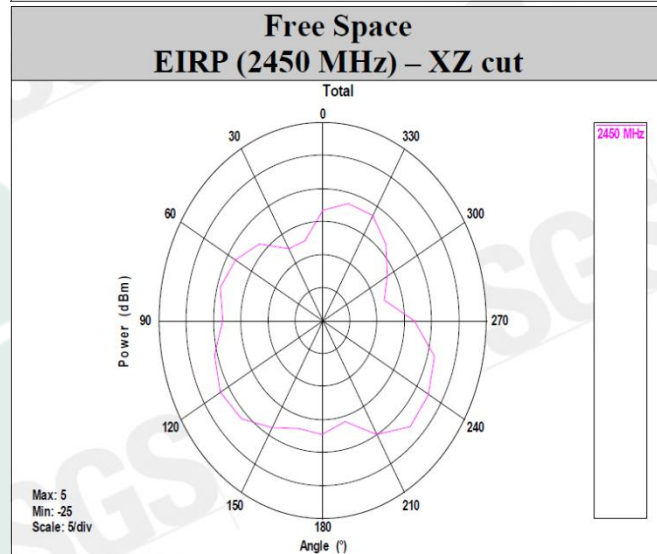
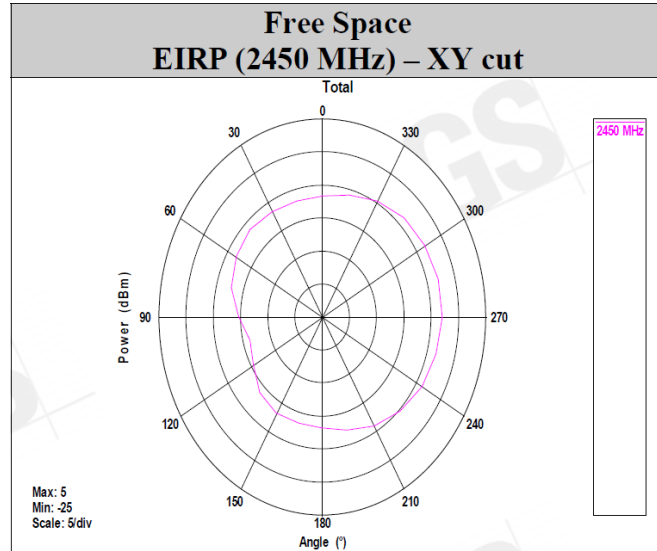

8. Reference Circuit

Module is pre-programmed with Raytac's testing code. Default is using "LDO mode". Our firmware is set to use external 32.768khz so please add it to make module work.

REMARK:

- ** DEC4 decoupling capacitor (1 μ F) is already inside the module. **
- ** When using DC-DC mode, please add L2 / L3 / C14. **
- ** When using internal 32.768khz RC oscillator, please remove X2 / C12 / C13. **

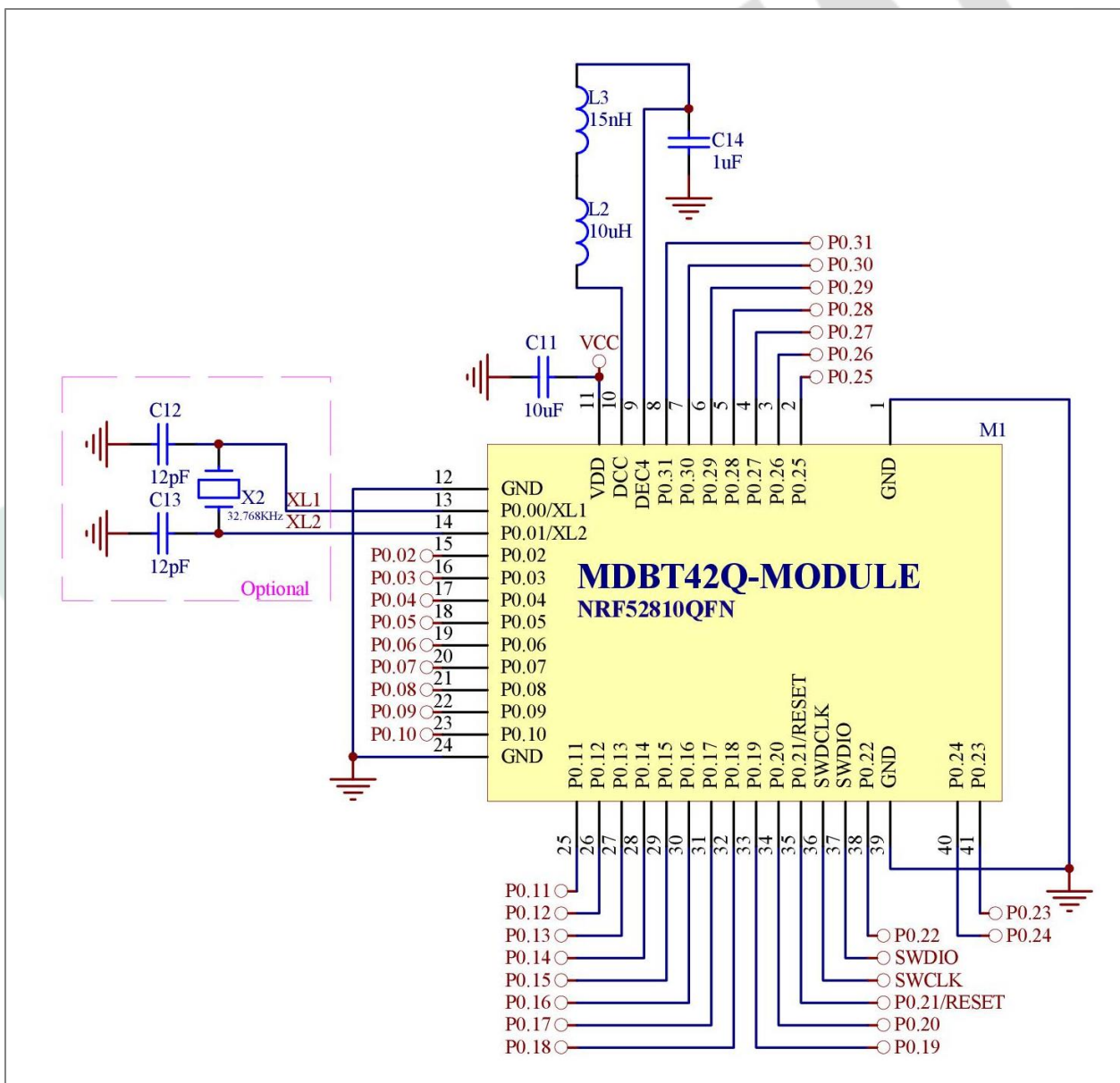

9. Certification

9.1. Declaration ID

BT 5.1

Declaration ID	QDID(s)	Company	Specification Name
D047708	139361 - End Product	Raytac Corporation	5.1

BT 5.2

Declaration ID	QDID(s)	Company	Specification Name
D053149	159932 - End Product	Raytac Corporation	5.2



Profile Description	Service Description
Alert Notification Profile	Alert Notification Service
Blood Pressure Profile	Blood Pressure Service
	Device Information Service
Cycling Speed & Cadence Profile	Cycling Speed & Cadence Service
	Device Information Service
Glucose Profile	Glucose Service
	Device Information Service
Health Thermometer Profile	Health Thermometer Service
	Device Information Service
Heart Rate Profile	Heart Rate Service
	Device Information Service
HID over GATT Profile	HID Service
	Battery Service
Proximity Profile	Link Loss Service
	Immediate Alert Service
	TX Power Service
Running Speed & Cadence Profile	Running Speed & Cadence Service
	Device Information Service
Time Profile	Time Profile Service
Glucose Profile (Central)	
Mesh Profile	Mesh Provisioning Service
	Mesh Proxy Service

9.2. FCC Certificate (USA)

BLE 1 Mbps



TCB

**GRANT OF EQUIPMENT
AUTHORIZATION**

Certification
Issued Under the Authority of the
Federal Communications Commission

By:

Telefication B.V.
Edisonstraat 12a
Zevenaar, NL-6902 PK
Netherlands

TCB

Raytac Corp.
5F., No.3, Jiankang Rd., Zhonghe Dist.,
New Taipei City,, 23586
Taiwan

Attention: Venson Liao , R&D Manager

Date of Grant: 02/21/2017

Application
Dated: 02/21/2017

NOT TRANSFERABLE

EQUIPMENT AUTHORIZATION is hereby issued to the named
GRANTEE, and is VALID ONLY for the equipment identified hereon for
use under the Commission's Rules and Regulations listed below.

FCC IDENTIFIER:	SH6MDBT42Q		
Name of Grantee:	Raytac Corp.		
Equipment Class:	Digital Transmission System		
Notes:	BT 4.2 Module		
Modular Type:	Single Modular		

Grant Notes	FCC Rule Parts	Frequency Range (MHZ)	Output Watts	Frequency Tolerance	Emission Designator
	15C	2402.0 - 2480.0	0.0023		

C2PC: To change module to be certified under portable device.
Power output listed is conducted. This grant is valid only when the module is sold to OEM integrators and must be installed by the OEM or OEM integrators. The antenna's as listed in this application must not be co-located or operating in conjunction with any other antenna or transmitter. End-users may not be provided with the module installation instructions. OEM integrators and end-users must be provided with transmitter operating conditions for satisfying RF exposure compliance.

Certificate No.: 162181172/AA/01	Mohammad Elhaj Product Assessor	
-------------------------------------	------------------------------------	---

BLE 2 Mbps



TCB

**GRANT OF EQUIPMENT
AUTHORIZATION**

TCB

Certification
Issued Under the Authority of the
Federal Communications Commission
By:

Telefication B.V.
Edisonstraat 12a
Zevenaar, NL-6902 PK
Netherlands

Date of Grant: 01/02/2018

Application
Dated: 12/18/2017

Raytac Corp.
5F., No.3, Jiankang Rd., Zhonghe Dist.,
New Taipei City., 23586
Taiwan

Attention: Venson Liao , R&D Manager

NOT TRANSFERABLE

EQUIPMENT AUTHORIZATION is hereby issued to the named
GRANTEE, and is VALID ONLY for the equipment identified hereon for
use under the Commission's Rules and Regulations listed below.

FCC IDENTIFIER: SH6MDBT42Q
Name of Grantee: Raytac Corp.
Equipment Class: Digital Transmission System
Notes: BLE Module
Modular Type: Single Modular

Grant Notes	FCC Rule Parts	Frequency Range (MHZ)	Output Watts	Frequency Emission Tolerance Designator
	15C	2402.0 - 2480.0	0.0023	

C2PC: add BT5.0 by Firmware and change product name to BLE module from BT 4.2 module. To change module to be certified under portable device.

Power output listed is conducted. This grant is valid only when the module is sold to OEM integrators and must be installed by the OEM or OEM integrators. The antenna's as listed in this application must not be co-located or operating in conjunction with any other antenna or transmitter. End-users may not be provided with the module installation instructions. OEM integrators and end-users must be provided with transmitter operating conditions for satisfying RF exposure compliance.

Certificate No.: 162181172/AA/02	George Lo Product Assessor	
-------------------------------------	-------------------------------	---

9.3. TELEC Certification (Japan)

BLE 1 Mbps

telefication bv
The Netherlands
Chamber of Commerce
51565536
www.telefication.com



telefication

Certificate
of
Radio Equipment in JAPAN

No: 201-160496 / 00

Telefication, operating as Conformity Assessment Body (CAB ID Number: 201) with respect to Japan, declares that the listed product complies with the Technical Regulations Conformity Certification of Terminal equipment (ordinance of MPT N° 31,1984)

Product description: **BT 4.2 Module**
Trademark: **Raytac**
Type designation: **MDBT42Q**
Hardware / Software version: 1 / 1
Variants: **See Annex 3**

Manufacturer: **Raytac Corporation**
Address: **5F, No.3, Jiankang Rd., Zhonghe Dist.,
City: New Taipei 23586**
Country: **Taiwan**

This statement is granted to:

Name: **Raytac Corporation**
Address: **5F, No.3, Jiankang Rd., Zhonghe Dist.,
City: New Taipei 23586**
Country: **Taiwan**

This statement has THREE Annexes.

Zevenaar, 19 August 2016

CAB



Ramy Nabod
Product Assessor



PRODUCTS
RvA C 224

BLE 2 Mbps

telefication by
The Netherlands
Chamber of Commerce
51565536
www.telefication.com



Certificate

of
Radio Equipment in JAPAN

No: 201-160496 / 02

Telefication, operating as Conformity Assessment Body (CAB ID Number: 201) with respect to Japan, declares that the listed product complies with the Technical Regulations Conformity Certification of Specified Radio equipment (ordinance of MPT N° 37,1981)

Product description: **BLE Module**
Trademark: **Raytac**
Type designation: **MDBT42Q**
Hardware / Software version: **1 / 1**
Variants: **See Annex 3**

Manufacturer: **Raytac Corporation**
Address: **5F, No. 3, Jiankang Rd., Zhonghe Dist.**
City: **23586 New Taipei City**
Country: **Taiwan**

This certificate is granted to:

Name: **Raytac Corporation**
Address: **5F, No. 3, Jiankang Rd., Zhonghe Dist.**
City: **23586 New Taipei City**
Country: **Taiwan**

This certificate has **THREE** Annexes.

Zevenaar, 23 May 2019

CAB

David Chen



David Chen
Product Assessor



9.4. NCC Certificate (Taiwan)

MDBT42Q Series

BLE 1 Mbps & 2 Mbps

國家通訊傳播委員會 電信管制射頻器材型式認證證明	
一、申請者：	勁達國際電子有限公司
二、地址：	臺北市大安區和平東路1段145號5樓之1
三、製造廠商：	勁達國際電子有限公司
四、器材名稱：	BLE Module
五、廠牌：	Raytac
六、型號：	MDBT42Q
七、發射功率(電場強度)：	詳細射頻規格如備註欄
八、工作頻率：	詳細射頻規格如備註欄
九、審驗日期：	105年08月19日(換證日期：108年06月19日)
十、審驗合格標籤式樣：	 
十一、警語或標示要求：(器材本體、使用手冊、外包裝盒等應遵守下列標示要求)	
1. 應依審驗合格標籤或符合性聲明標籤式樣自製標籤黏貼或印鑄於電信管制射頻器材本體明顯處，並於包裝盒標示本會標章，始得開陳列或販賣。	
2. 電信管制射頻器材應依本會或相關技術規範規定於指定位置標示中文警語。	
3. 經授權使用射頻模組(組件)之審驗合格標籤者，應於最終產品說明書及包裝盒提供充分與正確之資訊。	
4. 於網際網路販賣取得審驗證明之電信管制射頻器材者，應於該網際網路網頁提供審驗合格標籤或符合性聲明標籤資訊。	
5. 使用手冊應標示下列資訊： (1)經型式認證合格之低功率射頻電機，非經許可，公司、商號或使用者均不得擅自變更頻率、加大功率或變更原設計之特性及功能。低功率射頻電機之使用不得影響飛航安全及干擾合法通信；經發現有干擾現象時，應立即停用，並改善至無干擾時方得繼續使用。前項合法通信，指依電信法規定作業之無線電通信。低功率射頻電機須忍受合法通信或工業、科學及醫療用電波輻射性電機設備之干擾。	
6. 本器材之審驗範圍僅限無線射頻硬體功能，不及於器材之資通安全檢測。	
型式認證號碼：CCAM16LP1180T2	第 1 頁，共 2 頁
本證書與續頁分開使用無效	

MDBT42Q-P Series

BLE 1 Mbps & 2 Mbps

國家通訊傳播委員會 電信管制射頻器材型式認證證明

- 一、申請者：勁達國際電子有限公司
- 二、地址：臺北市大安區和平東路1段145號5樓之1
- 三、製造廠商：勁達國際電子有限公司
- 四、器材名稱：BLE Module
- 五、廠牌：Raytac
- 六、型號：MDBT42Q-P
- 七、發射功率(電場強度)：詳細射頻規格如備註欄
- 八、工作頻率：詳細射頻規格如備註欄
- 九、審驗日期：105年08月19日(換證日期：108年06月19日)

- 十、審驗合格標籤式樣：



- 十一、警語或標示要求：(器材本體、使用手冊、外包裝盒等應遵守下列標示要求)

1. 應依審驗合格標籤或符合性聲明標籤式樣自製標籤黏貼或印鑄於電信管制射頻器材本體明顯處，並於包裝盒標示本會標章，始得開陳列或販賣。
2. 電信管制射頻器材應依本會或相關技術規範規定於指定位置標示中文警語。
3. 經授權使用射頻模組(組件)之審驗合格標籤者，應於最終產品說明書及包裝盒提供充分與正確之資訊。
4. 於網際網路販賣取得審驗證明之電信管制射頻器材者，應於該網際網路網頁提供審驗合格標籤或符合性聲明標籤資訊。
5. 使用手冊應標示下列資訊：
(1)經型式認證合格之低功率射頻電機，非經許可，公司、商號或使用者均不得擅自變更頻率、加大功率或變更原設計之特性及功能。低功率射頻電機之使用不得影響飛航安全及干擾合法通信；經發現有干擾現象時，應立即停用，並改善至無干擾時方得繼續使用。前項合法通信，指依電信法規定作業之無線電通信。低功率射頻電機須忍受合法通信或工業、科學及醫療用電波輻射性電機設備之干擾。
6. 本器材之審驗範圍僅限無線射頻硬體功能，不及於器材之資通安全檢測。

9.5. CE Test Report (EU)

BLE 1 Mbps & 2 Mbps

SGS

SGS Reference No: MH/2019/40103C

VERIFICATION OF EMC COMPLIANCE

Verification No.	: MH/2019/40103C
Representative Model No.	: MDBT42Q
Added Model(s)	: MDBT42Q-P, MDBT42Q-U
Product Name	: BLE Module
Brand Name	: Raytac
Applicant	: Raytac Corporation
Address of Applicant	: 5F, No.3, Jiankang Rd., Zhonghe Dist., New Taipei City, 23586, Taiwan
Test Report Number	: MH/2019/40103
Date of Issue	: May 13, 2019
Applicable Standards	: EN 301 489 -1 _{v2.2.0} : 2017-03 (Draft) EN 301 489 -17 _{v3.2.0} : 2017-03 (Draft) EN 55032 : 2015+AC:2016-07 EN 61000-4-2 : 2009, EN 61000-4-3 : 2006+A1:2008+A2:2010

Conclusion
The apparatus meets the requirements of the above standards and hence compliance the essential requirements under article 3.1b of the RED (2014/53/EU) Directive.

*This verification is only valid for the equipment and configuration described, and in conjunction with the test report as detailed above.

Authorized Signatory:
Eddy Cheng

SGS TAIWAN LTD.
Eddy Cheng
Technical Asst. Supervisor



RED (2014/53/EU)
ETSI EN 300 328 v2.2.2 : 2019
TEST REPORT

FOR

Applicant: Raytac Corporation
5F, No.3, Jiankang Rd., Zhonghe Dist., New Taipei City ,
23586, Taiwan

Product Name: BLE Module

Brand Name: Raytac

Model No.: MDBT42Q, MDBT42Q-P

Model Difference: MDBT42Q with Chip antenna,
MDBT42Q-P with PCB antenna

Report Number: ER/2016/70008-05

Issue Date: May 15, 2020

Date of Test: Jul. 04, 2016 ~ Nov. 28, 2017 (Original)
Apr. 16, 2020 ~ May 04, 2020 (Updated)

Date of EUT Received: Jul. 04, 2016 (Original)
Apr. 16, 2020(Updated)

We hereby certify that:

The above equipment was tested by SGS Taiwan Ltd., Electronics & Communication Laboratory for compliance with the requirements set forth in the European Standard ETSI EN 300 328 v2.2.2: 2019 under RED 2014/53/EU. The results of testing in this report apply to the product system that was tested only. Other similar equipment will not necessarily produce the same results due to production tolerance and measurement uncertainties.

Approved By: _____

CHUN-CHIEH CHEN
Chun Chieh Chen / Supervisor



9.6. IC Certificate (Canada)

BLE 1 Mbps

<p>telefication bv The Netherlands Chamber of Commerce 51565536 www.telefication.com</p>		<p>telefication</p>						
<p>TECHNICAL ACCEPTANCE CERTIFICATE</p>		<p>CERTIFICAT D'ACCEPTABILITÉ TECHNIQUE</p>						
<p>CERTIFICATION No. No. DE CERTIFICATION</p>	<p>8017A-MDBT42Q</p>							
<p>TELEFICATION No. No. DE TELEFICATION</p>	<p>162170280/AA/01</p>							
<p>TEST SITE No. No. DE LABORATOIRE</p>	<p>4620A-5</p>							
<p>ISSUED TO DÉLIVRÉ A</p>	<p>Raytac Corporation</p>							
<p>TYPE OF EQUIPMENT GENRE DE MATÉRIEL</p>	<p>Bluetooth device</p>							
<p>TRADE NAME AND MODEL MARQUE ET MODELE</p>	<p>Raytac / MDBT42Q Raytac / MDBT42Q-P</p>							
<p>CERTIFIED TO CERTIFIÉ SELON LE</p>	<p>SPECIFICATION CAHIER DES CHARGES</p>	<table border="0"> <tr> <td>RSS-102</td> <td>ISSUE</td> <td>5</td> </tr> <tr> <td>RSS-247</td> <td>EDITION</td> <td>1</td> </tr> </table>	RSS-102	ISSUE	5	RSS-247	EDITION	1
RSS-102	ISSUE	5						
RSS-247	EDITION	1						
<p>Certification of equipment means only that the equipment has met the requirements of the above-noted specification. Licence applications, where applicable to use certified equipment, are acted on accordingly by the Industry Canada issuing office and will depend on the existing radio environment, service and location of operation. This certificate is issued on condition that the holder complies and will continue to comply with the requirements and procedures issued by Industry Canada. The equipment for which this certificate is issued shall not be manufactured, imported, distributed, leased, offered for sale or sold unless the equipment complies with the applicable technical specifications and procedures issued by Industry Canada.</p>	<p>La certification du matériel signifie seulement que le matériel a satisfait aux exigences de la norme indiquée ci-dessus. Les demandes de licences nécessaires pour l'utilisation du matériel certifié sont traitées en conséquence par le bureau de délivrance d'Industrie Canada et dépendent des conditions radio ambiantes, du service et de l'emplacement d'exploitation. Le présent certificat est délivré à la condition que le titulaire satisfasse et continue de satisfaire aux exigences et aux procédures d'Industrie Canada. Le matériel à l'égard duquel le présent certificat est délivré ne doit pas être fabriqué, importé, distribué, loué, mis en vente ou vendu à moins d'être conforme aux procédures et aux spécifications techniques applicables publiées par Industrie Canada.</p>							
<p>ISSUED BY TELEFICATION BV, RECOGNIZED CERTIFICATION BODY BY INDUSTRY CANADA DÉLIVRÉ PAR TELEFICATION BV, ORGANISME DE CERTIFICATION RECONNU PAR INDUSTRIE CANADA</p>								
<p><i>I hereby attest that the subject equipment was tested and found in compliance with the above-noted specification. J'atteste, par la présente, que le matériel a fait l'objet d'essai et a été jugé conforme à la spécification ci-dessus</i></p>								
<p>DATE 21 Feb 2017 BY</p>	<p>Mohammad Elhaj Product Assessor</p>							
<p>This certificate has one annex.</p>								
								

BLE 2 Mbps

telefication bv
The Netherlands
Chamber of Commerce
51565536
www.telefication.com



TECHNICAL ACCEPTANCE CERTIFICATE

CERTIFICAT D'ACCEPTABILITÉ TECHNIQUE

CERTIFICATION No. No. DE CERTIFICATION	8017A-MDBT42Q			
TELEFICATION No. No. DE TELEFICATION	162170280/AA/02			
TEST SITE No. No. DE LABORATOIRE	4620A-5			
ISSUED TO DELIVRE A	Raytac Corporation			
TYPE OF EQUIPMENT GENRE DE MATÉRIEL	Bluetooth device			
TRADE NAME AND MODEL MARQUE ET MODELE	Raytac / MDBT42Q Raytac / MDBT42Q-P			
CERTIFIED TO CERTIFIÉ SELON LE	SPECIFICATION CAHIER DES CHARGES	RSS-102 RSS-247	ISSUE EDITION	5 2

Certification of equipment means only that the equipment has met the requirements of the above-noted specification. Licence applications, where applicable to use certified equipment, are acted on accordingly by the ISED issuing office and will depend on the existing radio environment, service and location of operation. This certificate is issued on condition that the holder complies and will continue to comply with the requirements and procedures issued by ISED. The equipment for which this certificate is issued shall not be manufactured, imported, distributed, leased, offered for sale or sold unless the equipment complies with the applicable technical specifications and procedures issued by ISED.

La certification du matériel signifie seulement que le matériel a satisfait aux exigences de la norme indiquée ci-dessus. Les demandes de licences nécessaires pour l'utilisation du matériel certifié sont traitées en conséquence par le bureau de délivrance d'ISDE et dépendent des conditions radio ambiantes, du service et de l'emplacement d'exploitation. Le présent certificat est délivré à la condition que le titulaire satisfasse et continue de satisfaire aux exigences et aux procédures d'ISDE. Le matériel à l'égard duquel le présent certificat est délivré ne doit pas être fabriqué, importé, distribué, loué, mis en vente ou vendu à moins d'être conforme aux procédures et aux spécifications techniques applicables publiées par ISDE.

ISSUED BY TELEFICATION BV (NL0001), RECOGNIZED CERTIFICATION BODY BY INNOVATION, SCIENCE AND ECONOMIC DEVELOPMENT CANADA
DELIVRE PAR TELEFICATION BV (NL0001), ORGANISME DE CERTIFICATION RECONNU PAR INNOVATION, SCIENCES ET DEVELOPPEMENT ÉCONOMIQUE CANADA

*I hereby attest that the subject equipment was tested and found in compliance with the above-noted specification.
J'atteste, par la présente, que le matériel a fait l'objet d'essai et a été jugé conforme à la spécification ci-dessus*

DATE 02 Jan 2018 BY

George Lo
Product Assessor

This certificate has one annex.



9.7. SRRC Certificate (China)

BLE 1 Mbps & 2 Mbps

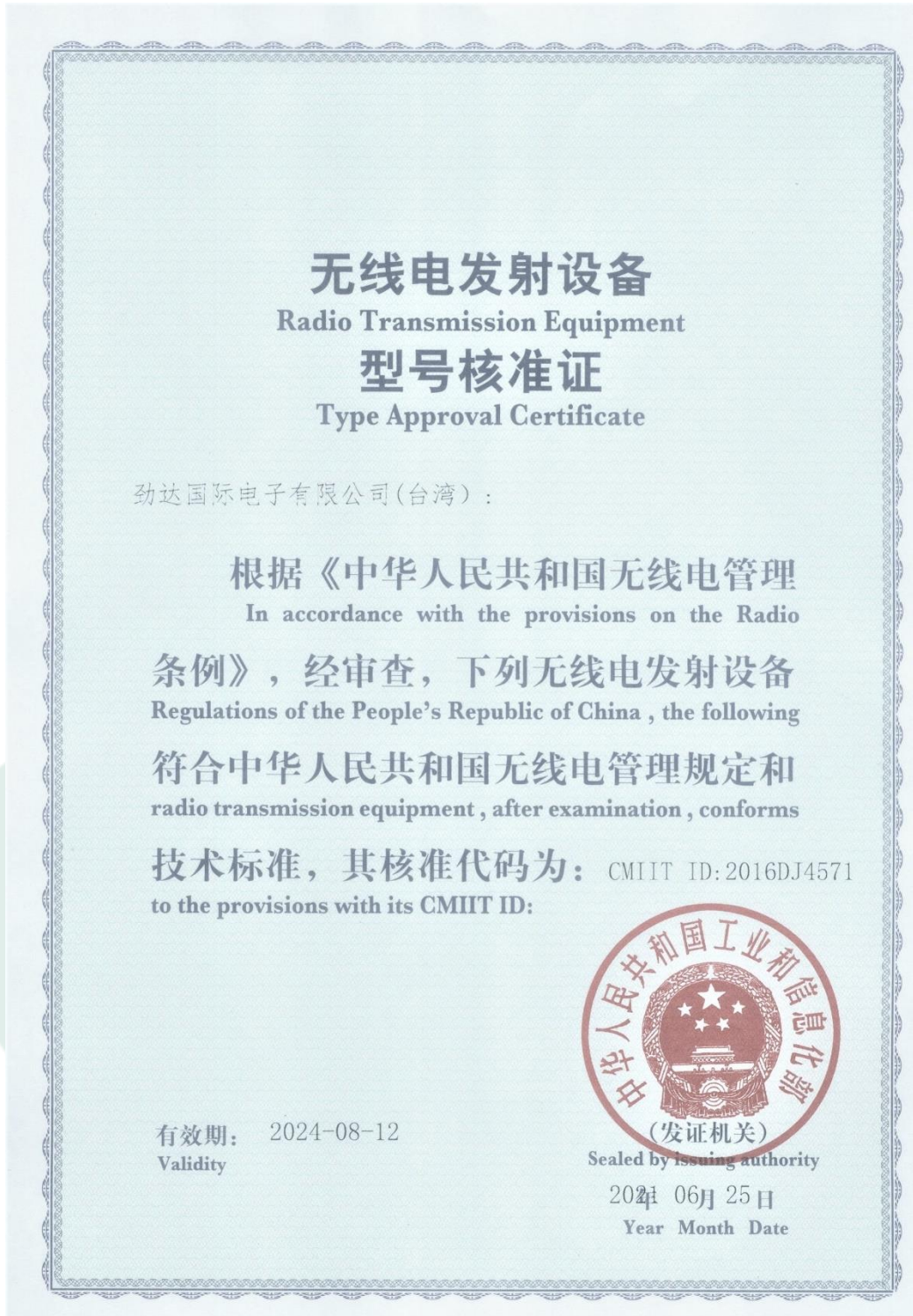

9.8. KC Certificate (South Korea)

BLE 1 Mbps & 2 Mbps

B58D-F9C0-417D-C63A

방송통신기자재등의 적합인증서 <i>Certificate of Broadcasting and Communication Equipments</i>	
상호 또는 성명 <i>Trade Name or Applicant</i>	Raytac Corporation
기자재명칭(명칭) <i>Equipment Name</i>	특정소출력 무선기기(무선데이터통신시스템용 무선기기)
기본모델명 <i>Basic Model Number</i>	MDBT42Q
파생모델명 <i>Series Model Number</i>	MDBT42Q-P, MDBT42Q-U
인증번호 <i>Certification No.</i>	MSIP-CRM-ryt-MDBT42Q
제조사/제조국가 <i>Manufacturer/ Country of Origin</i>	Raytac Corporation / 대만
인증연월일 <i>Date of Certification</i>	2016-10-06
기타 <i>Others</i>	
<p>위 기자재는 「전파법」 제58조의2 제2항에 따라 인증되었음을 증명합니다.</p> <p>It is verified that foregoing equipment has been certificated under the Clause 2, Article 58-2 of Radio Waves Act.</p> <p style="text-align: right;">2019년(Year) 05월(Month) 14일(Day)</p> <p style="text-align: center;">국립전파연구원장 </p> <p style="text-align: center;"><i>Director General of National Radio Research Agency</i></p> <p style="text-align: center; font-size: small;">※ 인증 받은 방송통신기자재는 반드시 "적합성평가표시" 를 부착하여 유통하여야 합니다. 위반시 과태료 처분 및 인증이 취소될 수 있습니다.</p>	



9.9. RoHS & REACH Report

Please visit "[Support](#)" page of our website to download.

9.10. End-Product Label

It is suggested using following content adding to package or user manual or label to obey the regulation. Any rules of end-product label shall refer to each certification for final reference.

9.10.1. FCC (USA)

The FCC statement should be included in the user manual when there is no enough space on label. Otherwise, it should be included on the label.

"This device complies with part 15 of the FCC rules. Operation is subject to the following two conditions. (1) This device may not cause harmful interference. (2) This device must accept any interference received, including interference that may cause undesired operation."

The final end product must be labeled in a visible area with the following: "Contain FCC ID: SH6MDBT42Q".

9.10.2. TELEC (Japan)

When manufacturer is placing the product on the Japanese market, the product must be affixed with the following Specified Radio Equipment marking:

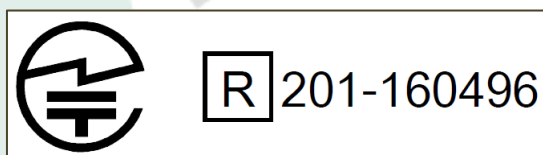

9.10.3. NCC (Taiwan)

請依下列標籤式樣自製標籤，標貼或印鑄於器材本體明顯處，始得販賣或公開陳列。

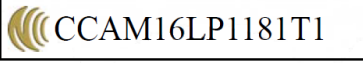
Series	標籤樣式
MDBT42Q Series	
MDBT42Q-P Series	

以 MDBT42Q 為例，平台廠商必須於平台上標示字樣「本產品內含射頻模組：ID 編號 CCAM16LP1180T2」。

「平台」定義如下：若器材組裝本案模組，消費者仍能正常使用該器材主要功能，該器材得視為平台。若器材不組裝本案模組，消費者不能正常使用該器材主要功能，該器材不能視為平台。該類不同廠牌型號器材組裝本案審驗模組後，須分別申請型式認證。

9.10.4. IC (Canada)

The IC statement should be included in the user manual when there is no enough space on label. Otherwise, it should be included on the label.

“This device complies with Industry Canada license-exempt RSS Standard(s). Operation is subject to the following two conditions. (1) This device may not cause harmful interference. (2) This device must accept any interference received, including interference that may cause undesired operation.

Le présent appareil est conforme aux CNR d'Industrie Canada applicables aux appareils radio exempts de licence. L'exploitation est autorisée aux deux conditions suivantes: (1) l'appareil ne doit pas produire de brouillage, et (2) l'utilisateur de l'appareil doit accepter tout brouillage radioélectrique subi, même si le brouillage est susceptible d'en compromettre le fonctionnement.”

The final end product must be labeled in a visible area with the following: “Contain IC ID: 8017A-MDBT42Q”.

10. Notes and Cautions

Module is not designed to last for a lifetime. Like general products, it is expected to be worn out after continuous usage through the years. To assure that product will perform better and last longer, please make sure you:

- Follow the guidelines of this document while designing circuit/end-product. Any discrepancy of core Bluetooth technology and technical specification of IC should refer to definition of Bluetooth Organization and Nordic Semiconductor as final reference.
- Do not supply voltage that is not within range of specification.
- Eliminate static electricity at any cost when working with the module as it may cause damage. It is highly recommended adding anti-ESD components to circuit design to prevent damage from real-life ESD events. Anti-ESD methods can be also applied in mechanical design.
- Do not expose modules under direct sunlight for long duration. Modules should be kept away from humid and salty air conditions, and any corrosive gasses or substances. Store it within -40°C to $+125^{\circ}\text{C}$ before and after installation.
- Avoid any physical shock, intense stress to the module or its surface.
- Do not wash the module. No-Clean Paste is used in production. Washing it will oxidize the metal shield and have chemistry reaction with No-Clean Paste. Functions of the module are not guaranteed if it has been washed.

The module is not suitable for life support device or system and not allowed to be used in destructive device or systems in any direct or indirect ways. The customer agrees to indemnify Raytac for any losses when applying modules in applications such as the ones described above.

11. Basic Facts for nRF52 Chip

Below chart shows basic spec for Nordic nRF52 family, which is helpful to understand the differences between each SoC. Any discrepancy shall refer to Nordic's technical document as final reference.

See [Full List of Raytac's BLE Modules](#) for complete model no. of each item.

Nordic Solution	nRF52840	nRF52833	nRF52820	nRF52832	nRF52810	nRF52811	nRF52805
RAYTAC Model No. (MDBTXX)	50Q series	50Q series 50 series	50 series	42Q series 42 series 42V series	42Q series	42Q Series	42T series 42TV series
Bluetooth Direction Finding		V	V			V	
Bluetooth 5 Long Range (125kbps)	V	V	V			V	
Bluetooth 5 High Speed	V	V	V	V	V	V	V
Bluetooth 5 Ad. Extention (x8)	V	V	V	V	V	V	V
Flash (kBytes)	1024	512	256	512	192	192	192
RAM (kBytes)	256	128	32	64	24	24	24
ANT Plus	V	V	V	V	V	V	
IEEE 802.15.4	V	V	V			V	
ARM® TrustZone® Cryptocell	V						
USB	V	V	V				
QSPI	V						
NFC	V	V		V			
I2S	V	V		V			
SPI, TWI, UART, PWM	V	V	V	V	V	V	without PWM
PDM	V	V		V	V	V	
ADC, Comparators	V	V	without ADC	V	V	V	without comparators
Supply Range (V)	1.7 to 5.5	1.7 to 5.5	1.7 to 5.5	1.7 to 3.6	1.7 to 3.6	1.7 to 3.6	1.7 to 3.6

12. Useful Links

- **Nordic Infocenter:** <https://infocenter.nordicsemi.com/index.jsp>
All the necessary technical files of Nordic's chip are on this website.
- **Nordic DevZone:** <https://devzone.nordicsemi.com/questions/>
A highly recommended website for firmware developer. Interact with other developers and Nordic's employees will help with your questions. The site also includes tutorials in detail to help you get started.
- **Official Page of nRF52810 :** <https://www.nordicsemi.com/eng/Products/nRF52810>
A brief introduction to nRF52810 and download links for Nordic's developing software and SoftDevices.



Full List of Raytac's BLE Modules

● MDBT40 Series

Series	Nordic Solution	Raytac No.	IC Ver.	Antenna	RAM	Flash Memory
MDBT40	nRF51822	MDBT40-256V3	3	Chip Antenna	16 kb	256 K
		MDBT40-256RV3			32 kb	256 K
MDBT40-P	nRF51822	MDBT40-P256V3	3	PCB Antenna	16 kb	256 K
		MDBT40-P256RV3			32 kb	256 K

● MDBT42Q Series (QFN Package IC)

Series	Nordic Solution	Raytac No.	IC Ver.	Antenna	RAM	Flash Memory
MDBT42Q	nRF52832	MDBT42Q-512KV2	2	Chip Antenna	64 kb	512 K
	nRF52810	MDBT42Q-192KV2	2		24 kb	192 K
	nRF52811	MDBT42Q-192KL	1			
MDBT42Q-P	nRF52832	MDBT42Q-P512KV2	2	PCB Antenna	64 kb	512 K
	nRF52810	MDBT42Q-P192KV2	2		24 kb	192 K
	nRF52811	MDBT42Q-P192KL	1			
MDBT42Q-U	nRF52832	MDBT42Q-U512KV2	2	u.FL Connector	64 kb	512 K

● MDBT42 Series (WLCSP Package IC)

Series	Nordic Solution	Raytac No.	IC Ver.	Antenna	RAM	Flash Memory
MDBT42	nRF52832	MDBT42-512KV2	2	Chip Antenna	64 kb	512 K
MDBT42-P		MDBT42-P512KV2		PCB Antenna		

● MDBT42V Series (WLCSP Package IC)

Series	Nordic Solution	Raytac No.	IC Ver.	Antenna	RAM	Flash Memory
MDBT42V	nRF52832	MDBT42V-512KV2	2	Chip Antenna	64 kb	512 K
MDBT42V-P		MDBT42V-P512KV2		PCB Antenna		

● MDBT42T Series (WLCSP Package IC)

Series	Nordic Solution	Raytac No.	IC Ver.	Antenna	RAM	Flash Memory
MDBT42T	nRF52805	MDBT42T-192K	1	Chip Antenna	24 kb	192 K
MDBT42T-P		MDBT42T-P192K		PCB Antenna		

● MDBT42TV Series (WLCSP Package IC)

Series	Nordic Solution	Raytac No.	IC Ver.	Antenna	RAM	Flash Memory
MDBT42TV	nRF52805	MDBT42TV-192K	1	Chip Antenna	24 kb	192 K
MDBT42TV-P		MDBT42TV-P192K		PCB Antenna		

● MDBT50Q Series (aQFN Package IC)

Series	Nordic Solution	Raytac No.	IC Ver.	Antenna	RAM	Flash Memory
MDBT50Q	nRF52840	MDBT50Q-1MV2	2	Chip Antenna	256 kb	1 MB
	nRF52833	MDBT50Q-512K	1		128 kb	512 kb
MDBT50Q-P	nRF52840	MDBT50Q-P1MV2	2	PCB Antenna	256 kb	1 MB
	nRF52833	MDBT50Q-P512K	1		128 kb	512 kb
MDBT50Q-U	nRF52840	MDBT50Q-U1MV2	2	u.FL Connector	256 kb	1 MB
	nRF52833	MDBT50Q-U512K	1		128 kb	512 kb
Dongle	nRF52840	MDBT50Q-RX	1, 2	PCB Antenna	256 kb	1 MB

● MDBT50 Series (QFN Package IC)

Series	Nordic Solution	Raytac No.	IC Ver.	Antenna	RAM	Flash Memory
MDBT50	nRF52820	MDBT50-256R	1	Chip Antenna	32 kb	256 kb
	nRF52833	MDBT50-512K	1		128 kb	512 kb
MDBT50-P	nRF52820	MDBT50-P256R	1	PCB Antenna	32 kb	256 kb
	nRF52833	MDBT50-P512K	1		128 kb	512 kb

● MDBT53 Series (WLCSP Package IC)

Series	Nordic Solution	Raytac No.	IC Ver.	Antenna	RAM	Flash Memory
MDBT53	nRF5340	MDBT53-1M	1	Chip Antenna	512 kb	1 MB
MDBT53-P	nRF5340	MDBT53-P1M	1	PCB Antenna	512 kb	1 MB
MDBT53-U	nRF5340	MDBT53-U1M	1	u.FL Connector	512 kb	1 MB

● MDBT53V Series (WLCSP Package IC)

Series	Nordic Solution	Raytac No.	IC Ver.	Antenna	RAM	Flash Memory
MDBT53V	nRF5340	MDBT53V-1M	1	Chip Antenna	512 kb	1 MB
MDBT53V-P	nRF5340	MDBT53V-P1M	1	PCB Antenna	512 kb	1 MB

Release Note

- 2017/08/02 Version A: 1st release
- 2017/11/10 Version B:
 - (1) Updated Chapter 2 (2.2, 2.3, 2.4 & 2.6), Chapter 4 (adding description of changing color of solder mask), Chapter 5 (updating technical spec based on Nordic nRF52810 PS V1.0), Chapter 9.1 (adding BT 5.0 certificate), and full list of model no..
 - (2) Added Chapter 10: Basic Facts for nRF52 Chip and Chapter 11: Useful Links.
- 2017/12/26 Version C:
 - (1) Updated Chapter 4 (removing marking info), Chapter 8 (revising typo of two C13).
- 2018/08/03 Version D:
 - (1) Added remarks of P0.23/P0.24 and updated link of design guide in Chapter 2.
 - (2) Updated technical spec in Chapter 5 and list of model no.
 - (3) Added CE EN300 328 (RED) compliant proof and updated link for RoHS & REACH report in Chapter 9.
 - (4) Added Chapter 10: Notes and Cautions.
- 2019/06/14 Version E:
 - (1) Updated technical spec in Chapter 5: Specification.
 - (2) Updated description of test code in Chapter 8: Reference Circuit.
 - (3) Added BT 5.0 Certificates in Chapter 9: Certification.
 - (4) Added nRF52811 information in Chapter 11: Basic Facts for nRF52 Chip.
 - (5) Added MDBT42Q-U in Full List of Raytac's BLE Modules.
- 2019/08/23 Version F:
 - (1) Updated model no. to MDBT42Q-192KV2 & MDBT42Q-P192KV2 in corresponding to revision 2 IC in Chapter 4: Shipment Packaging Information and front page.
 - (2) Added tolerance of PCB Size in Chapter 2: Product Dimension.
 - (3) Refined description for RF Layout Suggestion.
 - (4) Updated NCC certificates in Chapter 9: Certification.

- 2020/06/15 Version G:
 - (1) Updated CE reports to EN300.328 V2.2.2 & EN62368-1 in Chapter 9: Certification.
 - (2) Added nRF52820 in Chapter 11: Basic Facts of nRF52 Family.
 - (3) Updated Full List of Raytac's BLE modules.

- 2020/12/31 Version H
 - (1) Updated information of T&R in Chapter 4: Shipment Packaging Information.
 - (2) Added BT 5.2 SIG approval in Chapter 9: Certification.
 - (3) Updated table in Chapter 11: Basic Facts for nRF52 Family.
 - (4) Updated Full List of Raytac's BLE Modules.

- 2021/07/07 Version I
 - (1) Updated graphs in section 2 of Chapter 2: Product Dimension.
 - (2) Updated information of T&R in Chapter 4: Shipment Packaging Information.
 - (3) Refined description of test code in Chapter 8: Reference Circuit
 - (4) Updated SRRC certificate in Chapter 9: Certification

- 2022/07/01 Version J
 - (1) Updated Chapter 4: 4.3.1 Tray Packaging with 4.3.2 Tape & Reel Packaging info.
 - (2) Updated Chapter 2: 2.3 RF Layout Suggestion (aka Keep-Out Area).
 - (3) Updated List of Raytac's Model no.
 - (4) Updated Chapter 5: Specification corresponding to Nordic's new nRF52810 Product Specification V1.4.