

D-SUB Series

KLS1-DBJ D-SUB HOOD Plastic Material (Chromium plated) 09-37Pin

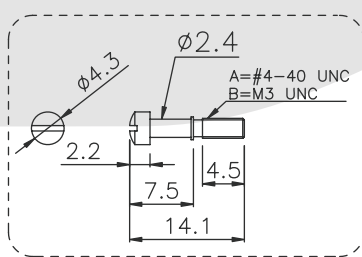

Cover Material: ABS PLASTIC HOOD Chromium plated
Screw Material: STEEL



Short screw

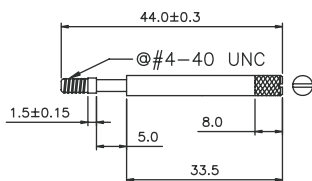
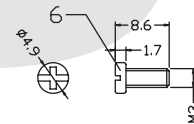
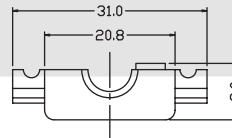
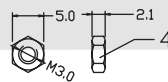
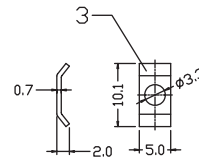
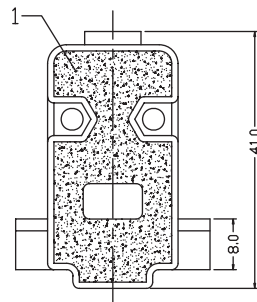
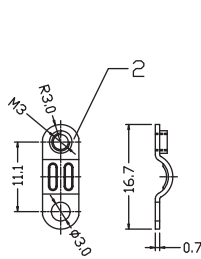

Long screw

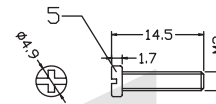
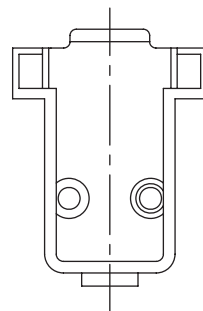

ORDER INFORMATION

Product NO.: KLS1-DBJ-09P-L

Pos. NO.
001=001 pos.

Contact Number of Row
DBJ=D-SUB HOOD Plastic Material
(Chromium plated)

L : Long screw
S : Short screw

Number of Contacts

D-SUB Series

KLS1-DBJ D-SUB HOOD Plastic Material (Chromium plated) 09-37Pin

Cover Material: ABS PLASTIC HOOD Chromium plated
Screw Material: STEEL

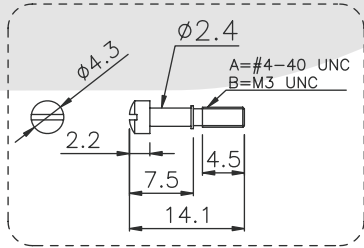
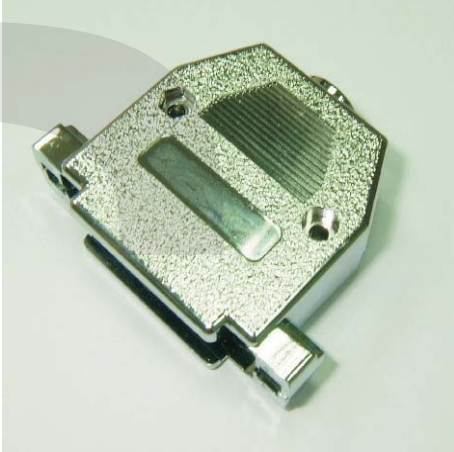

Short screw

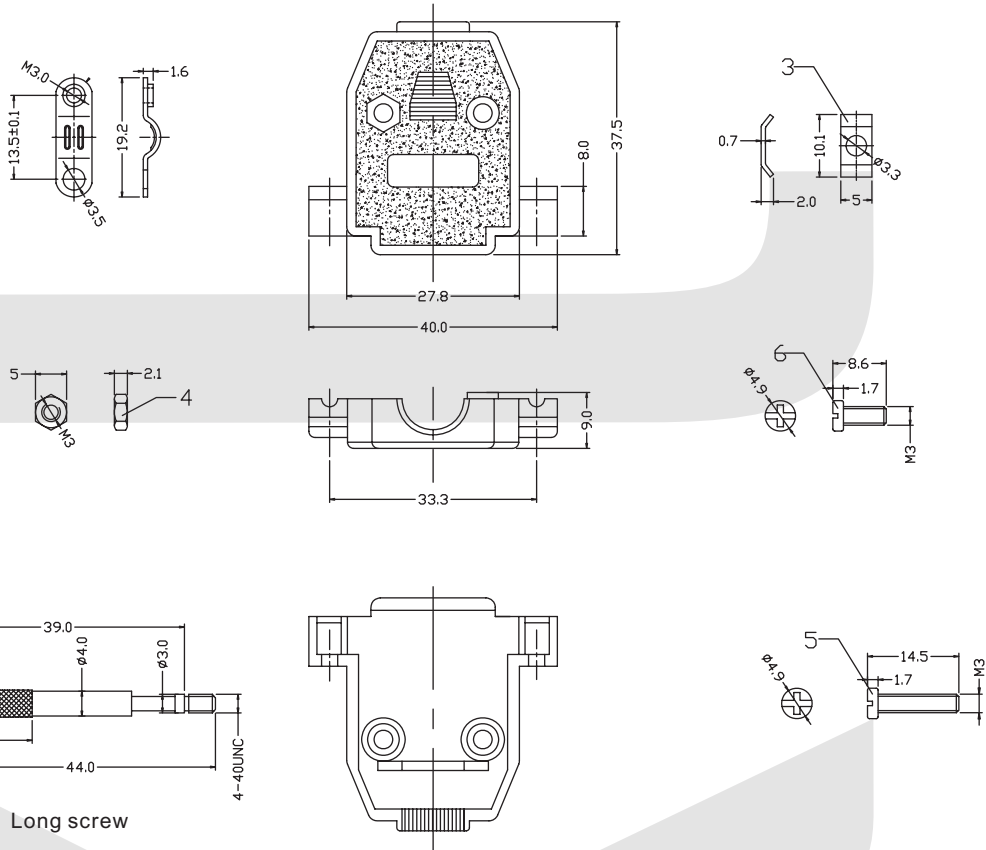

Long screw

ORDER INFORMATION

Product NO.: KLS1-DBJ-15P-L

Pos. NO. 001=001 pos.	L: Long screw S: Short screw
Contact Number of Row DBJ=D-SUB HOOD Plastic Material (Chromium plated)	Number of Contacts

D-SUB Series

KLS1-DBJ D-SUB HOOD Plastic Material (Chromium plated) 09-37Pin



Cover Material: ABS PLASTIC HOOD Chromium plated
Screw Material: STEEL

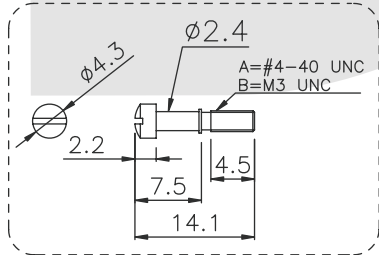

Short screw

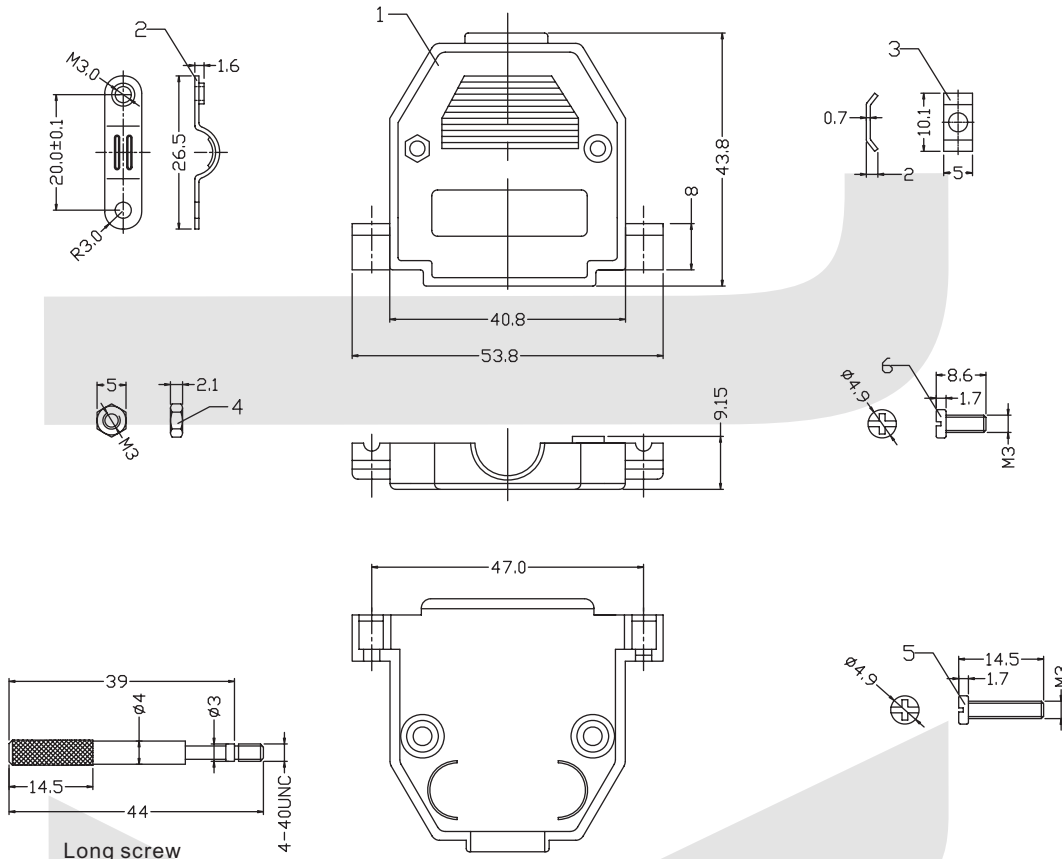

Long screw

ORDER INFORMATION

Product NO.: KLS1-DBJ-25P-L

Pos. NO. _____ L : Long screw
001=001 pos. _____ S : Short screw

Contact Number of Row _____ Number of Contacts
DBJ=D-SUB HOOD Plastic Material
(Chromium plated)

D-SUB Series

KLS1-DBJ D-SUB HOOD Plastic Material (Chromium plated) 09-37Pin



Cover Material: ABS PLASTIC HOOD Chromium plated
Screw Material: STEEL

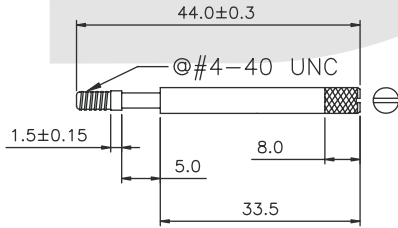
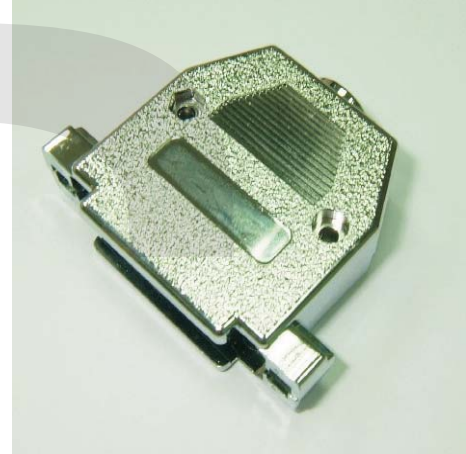

Long screw

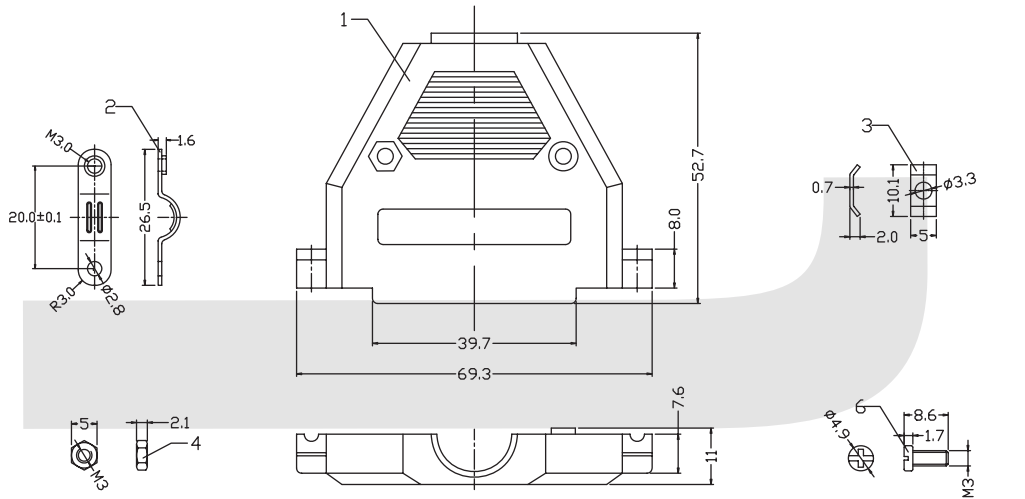

Short screw

ORDER INFORMATION

Product NO.: KLS1-DBJ-37P-L

Pos. NO. 001=001 pos.	L : Long screw S : Short screw
Contact Number of Row DBJ=D-SUB HOOD Plastic Material (Chromium plated)	Number of Contacts