

Veri sayfası | Ürün numarası: 221-415

COMPACT Splicing Connectors; 5-conductor connector; with operating levers; Max.ambient operating temp. 85 °C

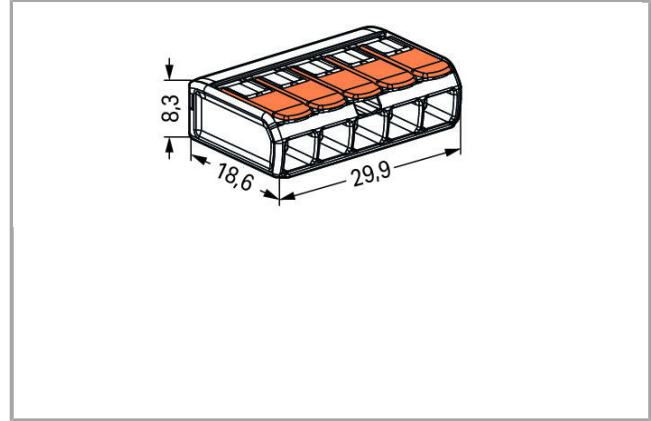

www.wago.com/221-415



RoHS
Compliant

BOMcheck.net



Ürün tanımı

Safety information 1:
In grounded power lines

Veri
Elektrik Verisi

Ratings per IEC/EN 60664-1

Anma gerilimi (II / 2)	450 V
Şok gerilimi(2)	4 kV
Nominal akım	32 A

Bağlantı verisi

Bağlantı teknolojisi	CAGE CLAMP®
Actuation type	Lever
Connectable conductor materials	Copper
Nominal kesit	4 mm ²
Tek damarlı boylar	0,2 ... 4 mm ² / 24 ... 12 AWG
bükümlü, bağlanabilir	0,2 ... 4 mm ² / 24 ... 12 AWG
İnce bükümlü kablolar	0,14 ... 4 mm ² / 24 ... 12 AWG
Sıyırma uzunluğu	11 mm / 0.43 inch
Toplam bağlantı noktası sayısı	5
Toplam potansiyel sayısı	1
Kablolama tipi	Yandan girişli kablolama

Geometrical Data

Width	1,177 mm / 1.177 inch
Height	8,3 mm / 0.327 inch
Depth	18,6 mm / 0.732 inch

Material Data

Renk	şeffaf
UL 94'e göre tutuşabilirlik değeri	V2
Yangın yükü	0.074 MJ
Ağırlık	4.048 g

Environmental Requirements



Surrounding air (operating) temperature	85 °C
Continuous operating temperature	105 °C
T-Marking per EN 60998	T85

Ticari Veri

Product Group	7 (Push Wire Conn.)
Country of origin	DE
GTIN	4055143234658

Onaylar / Belgeler



Country specific Approvals

Logo	Onay	İlave Onay Metni	Belge adı
	CCA DEKRA Certification B.V.	EN 60998	NTR NL- 7642
	CCA DEKRA Certification B.V.	EN 60998	71- 101731

Ship Approvals

Logo	Onay	İlave Onay Metni	Belge adı
	ABS American Bureau of Shipping	-	18- HG1755093- PDA
	DNV GL Det Norske Veritas, Germanischer Lloyd	EN 60998	TAE000015T
	LR Lloyds Register	EN 60998	04/20013 (E6)

UL-Approvals



Logo	Onay	İlave Onay Metni	Belge adı
	UL Underwriters Laboratories Inc.	UL 467	E201573
	UL Underwriters Laboratories Inc.	UL 486C	E69654

Uyumlu ürünler

Mounting adapter

Ürün no.: 221-500
Mounting carrier; 221 Series - 4 mm²; for DIN-35 rail mounting/screw mounting

www.wago.com/221-500

	Ürün no.: 221-505 Mounting carrier; for 5-conductor terminal blocks; 221 Series - 4 mm ² ; for screw mounting	www.wago.com/221-505
	Ürün no.: 221-505/000-004 Mounting carrier; for 5-conductor terminal blocks; 221 Series - 4 mm ² ; for screw mounting	www.wago.com/221-505/000-004
	Ürün no.: 221-515 Mounting carrier; for 5-conductor terminal blocks; 221 Series - 4 mm ² ; with snap-in mounting foot for horizontal mounting	www.wago.com/221-515
	Ürün no.: 221-515/000-004 Mounting carrier; for 5-conductor terminal blocks; 221 Series - 4 mm ² ; with snap-in mounting foot for horizontal mounting	www.wago.com/221-515/000-004
	Ürün no.: 221-525 Mounting carrier; for 5-conductor terminal blocks; 221 Series - 4 mm ² ; with snap-in mounting foot for vertical mounting	www.wago.com/221-525
	Ürün no.: 221-525/000-004 Mounting carrier; for 5-conductor terminal blocks; 221 Series - 4 mm ² ; with snap-in mounting foot for vertical mounting	www.wago.com/221-525/000-004
	Ürün no.: 222-505 Strain relief plate; for mounting carrier; 221 or 222 Series, can be snapped	www.wago.com/222-505
	Ürün no.: 222-510 Angled DIN-rail adapter; in combination with mounting carrier; 221-500 or 222-500; for DIN-35 rail mounting	www.wago.com/222-510

Dosya İndirme

CAD/CAE - Smart Data

CAD data

	URL	İndir
3D Download 221-415		

Değişikliklere tabidir.

WAGO Kontakttechnik GmbH & Co. KG
Hansastr. 27
32423 Minden
Phone: +49571 887-0 | Fax: +49571 887-169
Email: info.de@wago.com | Web: www.wago.com

Ürünlerimizle ilgili sorularınız mı var?
{0} numaralı telefondan sizinle konuşmaktan mutluluk duyarız.