

REVISION RECORD

REV	ECN	DESCRIPTION	DRFT	DATE
-----	-----	-------------	------	------

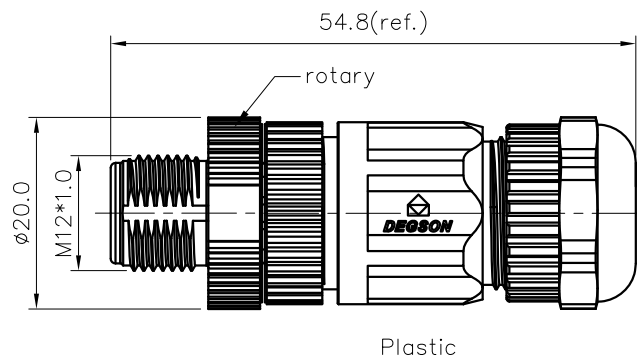
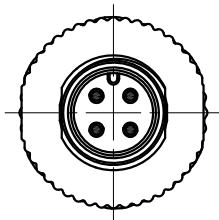

Plastic

NOTES:

- Rated voltage/current : 3pin A: 250V / 4A
4pin A: 250V / 4A
5pin A: 60V / 4A
6pin A: 30V / 2A
8pin A: 30V / 2A
5pin B: 60V / 4A
4pin D: 250V / 4A
- Withstanding voltage : AC1060V/1Min
- Levels of protection: IP67
- Wire range :
 - 3pin A: 24~20AWG/0.25~0.52mm²
 - 4pin A: 24~20AWG/0.25~0.52mm²
 - 5pin A: 24~20AWG/0.25~0.52mm²
 - 6pin A: 24~20AWG/0.25~0.52mm²
 - 8pin A: 24~20AWG/0.25~0.52mm²
 - 5pin B: 24~20AWG/0.25~0.52mm²
 - 4pin D: 24~20AWG/0.25~0.52mm²

- Cable OD: 4~8mm
- Wire connection mode: screw
- Operating temperature: -40°C~+85°C
- RoHS Compliance

PB-M12X-XXP-MM-SL7001-00A(H)

Coding: A,B,D

Pin number: 03,04,05,
06,08

5pin B Coding

4pin D Coding

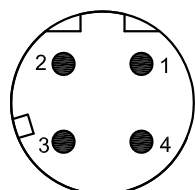
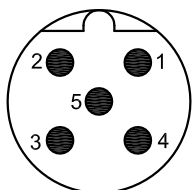

Pin Assignments
Front View

Pin Assignments
Front View

3pin A Coding

4pin A Coding

5pin A Coding

6pin A Coding

8pin A Coding

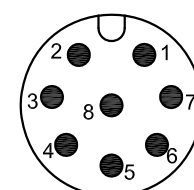
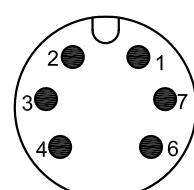
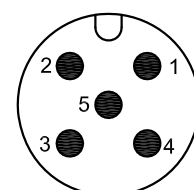
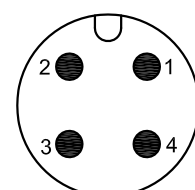
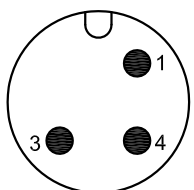

Pin Assignments
Front View

Pin Assignments
Front View

Pin Assignments
Front View

Pin Assignments
Front View

Pin Assignments
Front View

DETACHED LISTS	PART NO.: PBM12XXXPMMSL700100AH	宁波高松电子有限公司 NINGBO DEGSON ELECTRICAL CO., LTD		
	APPD:	NAME: PB-M12X-XXP-MM-SL7001-00A(H)		
	CHKD:	TITLE: CUSTOMER DRAWING		
	DRFT: LZ 2018.10.08	REV: D0-1	SHEET: 1/1	SCALE: 1:1
THIRD ANGLE PROJECTION		DRAWING NO.: XXXXXXXX-XX-CXX		DO NOT SCALE DRAWING

THIRD ANGLE PROJECTION

MM (INCH)
DO NOT SCALE DRAWING