

panel cut out

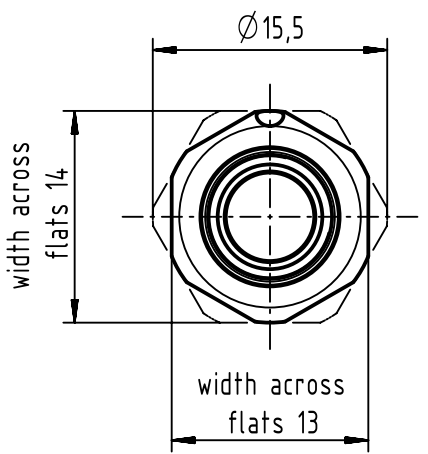

- recommended PCB: 1.6mm
- recommended torque for the lock nut: 0.6Nm
- 25 pieces per package

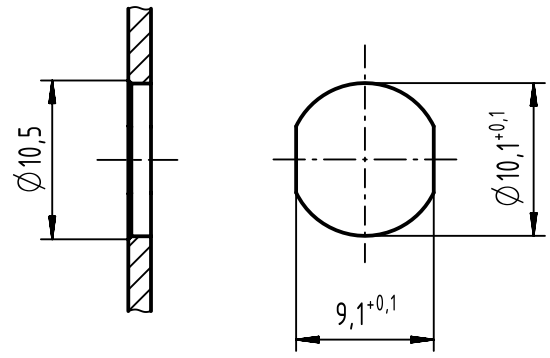
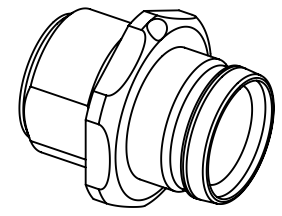

	All rights reserved Department EL PD	All Dimensions in mm Original Size DIN A4		Scale 2:1	Free size tol.	Ref. Sub.
		Created by HASSE	Inspected by HAEMMERLING	Standardisation HOFFMANN	Date 2020-02-26	State Final Release
HARTING Electronics GmbH D-32339 Espelkamp		Title M8-PP-ACC-HOUSING			Doc-Key / ECM-Nr. 100766439/UGD/002/B 500000167543	
		Type TB	Number 21023012002		Rev. B	Page 1/1