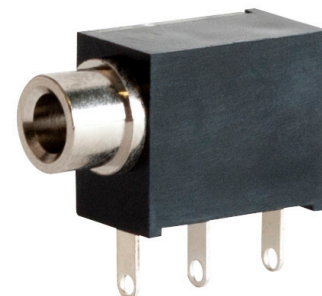

MODEL: MJ-3502N | **DESCRIPTION:** AUDIO JACK**FEATURES**

- 3.5 mm mono jack
- through hole
- flashed bushing

**SPECIFICATIONS**

parameter	conditions/description	min	typ	max	units
rated input voltage			12		Vdc
rated input current				2	A
contact resistance ¹				30	mΩ
insulation resistance	at 500 Vdc	100			MΩ
voltage withstand	at 50/60Hz for 1 minute			500	Vac
insertion force		0.4		2	kgf
withdrawal force		0.3		2	kgf
operating temperature		-25		70	°C
storage temperature		-25		70	°C
life			5,000		cycles
flammability rating	see material table for details				
RoHS	yes				

Note: 1. When measured at a current of less than 100 mA/1 kHz
 2. All specifications measured at 10~35°C, humidity at 45~85%, under standard atmospheric pressure, unless otherwise noted.

SOLDERABILITY

parameter	conditions/description	min	typ	max	units
hand soldering	for 3~5 seconds		360		°C

MECHANICAL DRAWING

units: mm[inch]
tolerance: ±0.3 mm

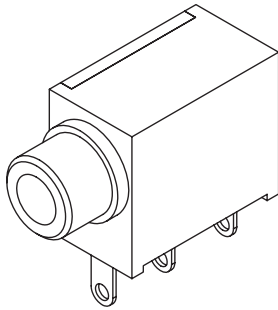

	MATERIAL	PLATING
terminal 1	brass	silver
terminal 2	phosphor bronze	silver
terminal 3	brass	silver
barrel	brass	nickel
housing	POM (UL94V-0)	black
cover	PC (UL94V-2)	transparent

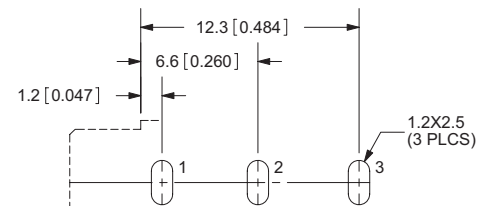
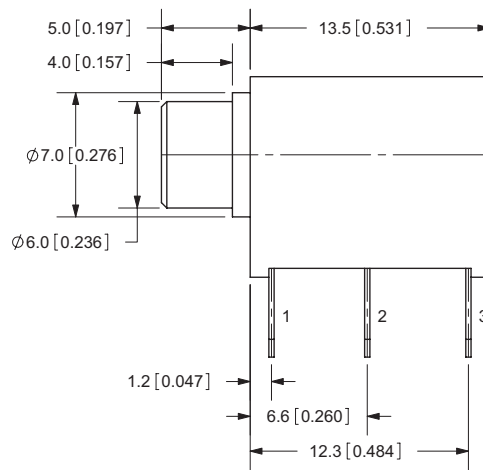
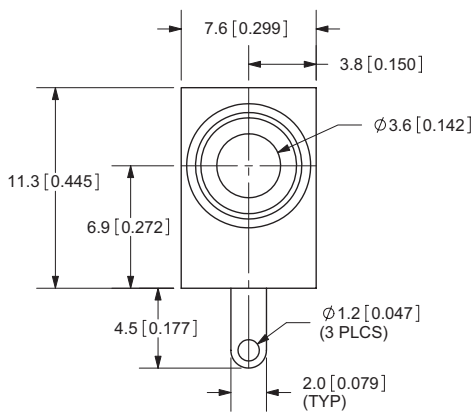

Recommended PCB Layout
Top View

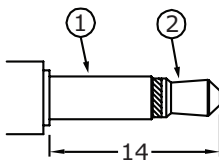

Ø3.5 MATING PLUG

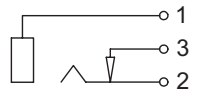
Model No.	MJ-3502N
Schematic	
PIN	
1	sleeve
2	tip
3	tip switch

REVISION HISTORY

rev.	description	date
1.0	initial release	07/06/2007
1.01	brand update	04/01/2020

The revision history provided is for informational purposes only and is believed to be accurate.

CUI DEVICES

CUI Devices offers a one (1) year limited warranty. Complete warranty information is listed on our website.

CUI Devices reserves the right to make changes to the product at any time without notice. Information provided by CUI Devices is believed to be accurate and reliable. However, no responsibility is assumed by CUI Devices for its use, nor for any infringements of patents or other rights of third parties which may result from its use.

CUI Devices products are not authorized or warranted for use as critical components in equipment that requires an extremely high level of reliability. A critical component is any component of a life support device or system whose failure to perform can be reasonably expected to cause the failure of the life support device or system, or to affect its safety or effectiveness.