

产品说明 Product Description:

1.表面处理 Surface treatment:

电镀Sn, Tin plating

2.外观 Appearance:

>30CM距离, <5S目视, 无腐蚀、刮伤、氧化

No corrosion, scratches, oxidation on surface

Inspection condition:

Inspect from >30cm away and for <5 seconds

3.环保: 符合ROHS&REACH

RoHS&REACH compliance: Yes

REV. (版本)	DESCRIPTION (修改内容)	DATE. (日期)

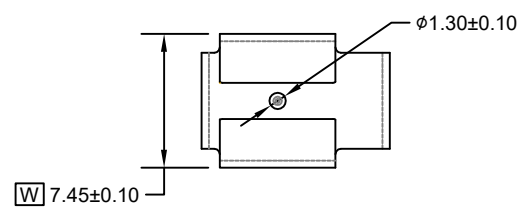
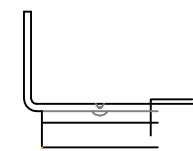
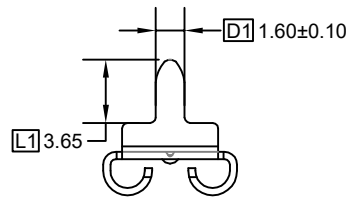
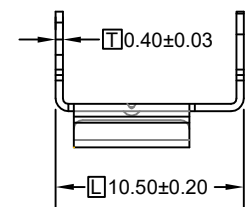
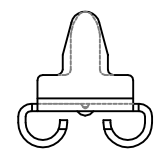
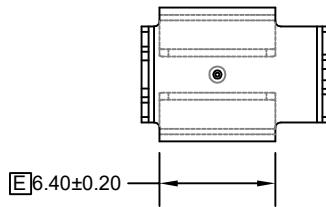
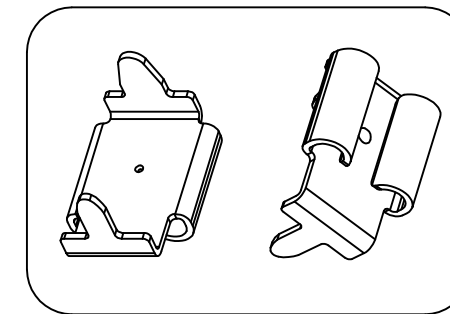

**所下载之产品规格表
仅供参考用**
 The products of download is only for reference

核准 APPROVED		审核 CHECKED		制图 DRAWING		尺寸单位 Units		mm	
						日期 DATE		版本 REV.	

产品料号 Part NO.	B250270BL2	文件名称 File Name	规格图 Product Specification
产品规格 Note	-	文件编号 File NO.	-
客户料号 Customer's Part NO.	-	单重 Single Weight	-
材质 Material	黄铜Brass(C2680)	包装数量 Packing Q' TY	5000Pcs/Bag
适配端子 Mating Part/ Spec.	(W)6.15*(T)0.8 专用公端	认证编号 Certification NO.	-

