

△3 Date Code: **X XX X**
 year day(1~7)
 week(1~52)

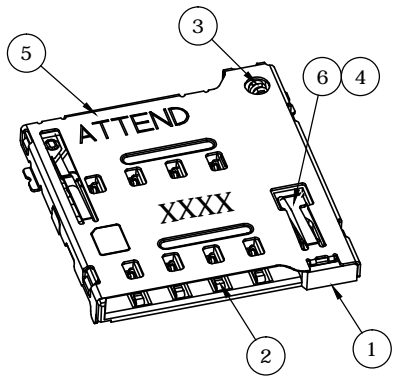

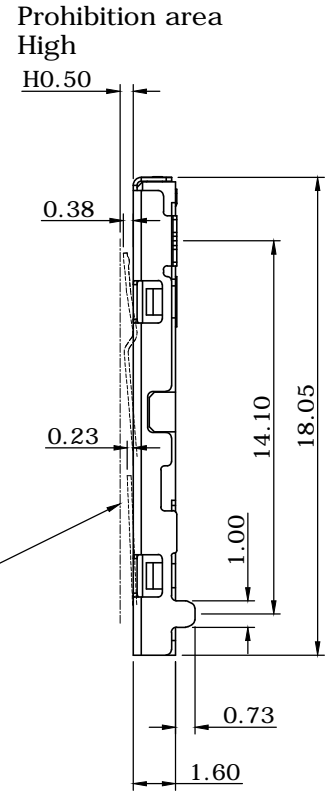
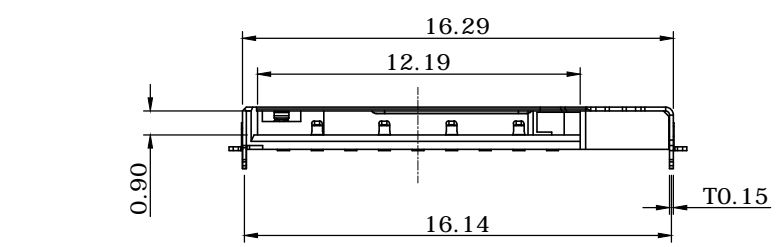
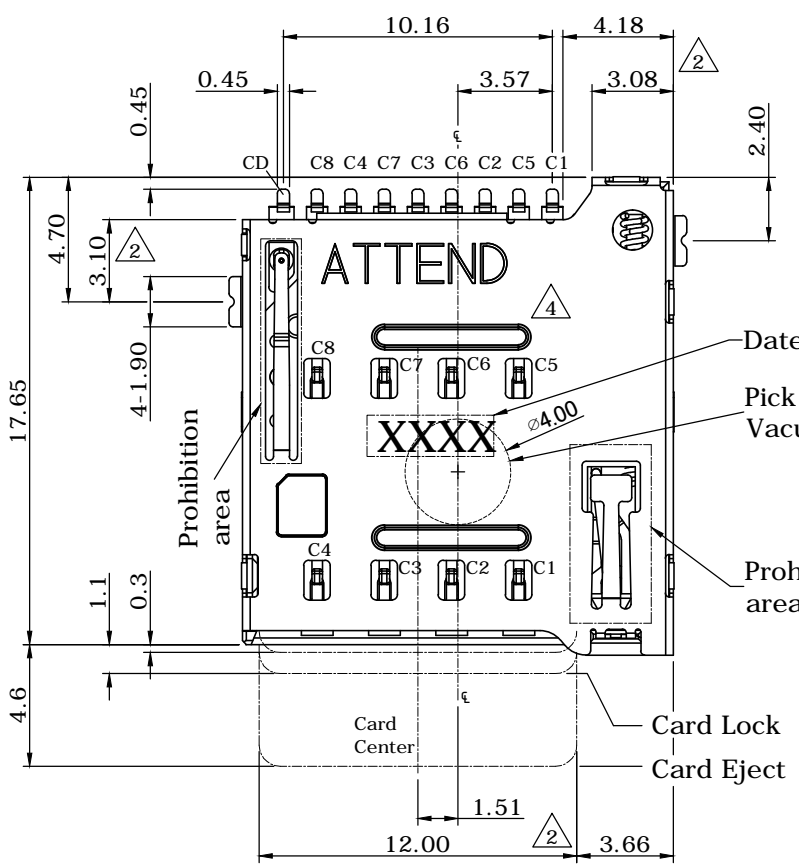

REV.	DESCRIPTION	DRAWN	DATE
3	Revised datecode	FROS	2016/08/19
4	ECR1800010 add Rib	FROS	2018/05/10
5	ECR2100001	FROS	2021/01/21

SPECIFICATION:

1. ELECTRICAL
 - 1.1 Current Rating: 0.5A DC/AC
 - 1.2 Voltage Rating: 10V DC/AC
 - 1.3 Contact Resistance:
 - C1~C8: 100mΩ Max.
 - CD: 140mΩ Max.**
 - 1.4 Insulation Resistance: 1000MΩ Min.
 - 1.5 Dielectric Withstanding Voltage:
 - 500VAC for 1 minute
2. MECHANICAL
 - 2.1 Durability: 5,000 Cycle
 - 2.2 Insertion Force: 10N Max.
 - 2.3 Extraction Force: 0.5N Min.
3. ENVIRONMENTAL
 - 3.1 Operating temperature range: -40°C~+85°C
 - 3.2 Storage temperature range: -40°C~+85°C

NO.	PART NAME	DESCRIPTION
6	SLIDER	LCP E130i, UL94V-0, Black
5	SHELL	SUS304CSP-3/4H, 0.15t, 50u" nickel plated
4	CRANK	SUS304, 0.35d
3	SPRING	SWP-B, 0.20d, 65u" nickel Plating over all
2	CONTACT	C5210R-H, 0.12t, 5u" gold on contact area 1u" gold on tail area, under plated: 50u" nickel
1	HOUSING	LCP E130i, UL94V-0, Black

UNLESS OTHERWISE SPECIFIED TOLERANCE						
UNIT:	DECIMAL	LINEAR	ANGLES			
mm	X.	±0.50	±5°	WWW.ATTEND.COM.TW		
	X.X	±0.25	±3°			
	X.XX	±0.12	±1°			
DRAWN	Fros	2014/11/24	DRAWN NAME:			
CHECKED	Ron	2014/11/24	Micro SIM Card Socket push-push type			
APPROVED	Albert	2014/11/24	PRODUCT NO.	115Q-BCA0		
	SCALE	3.5/1	SHEET	1/4	SIZE	A4
	FILE NAME		115Q-BCA0_B_5			

REV.	DESCRIPTION	DRAWN	DATE
	SEE SHEET 1		

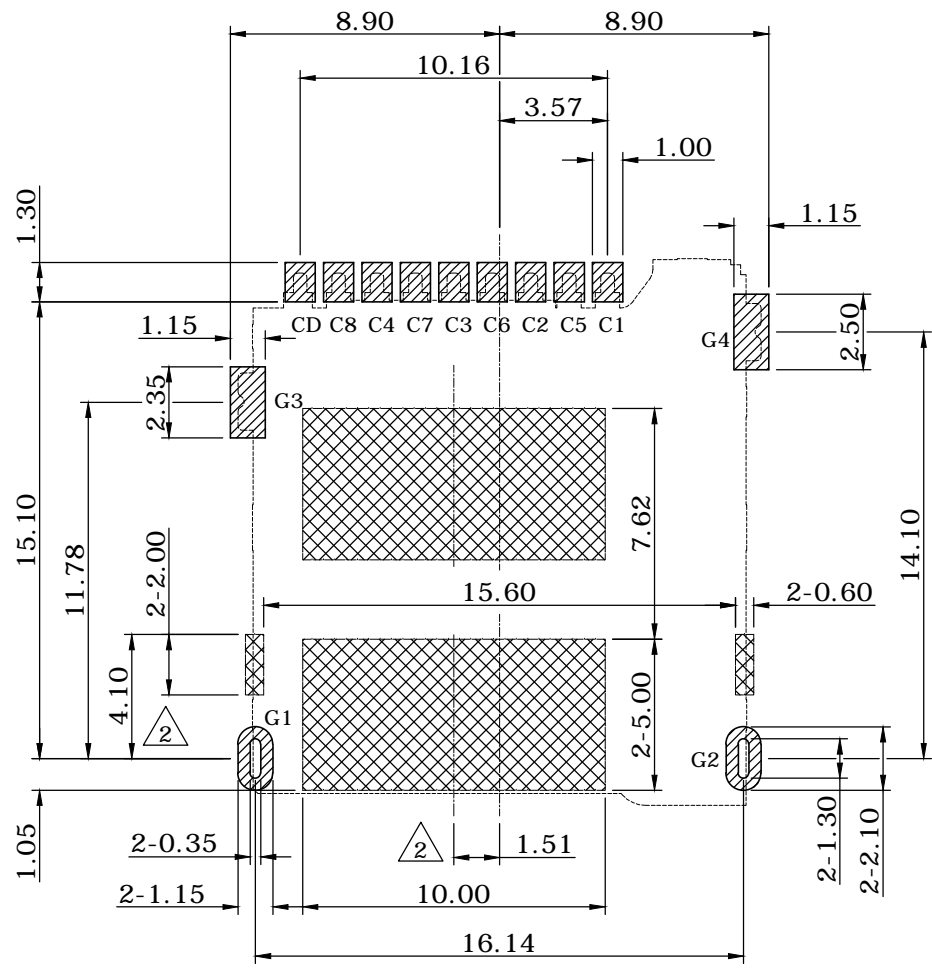

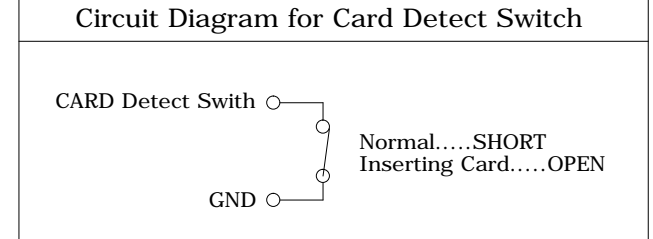

Connector terminal NO.	Pin Name
C 1	VCC:PWR signal and GND
C 2	RST:Reset singal
C 3	CLK:Clocking singal
C 4	Reserved
C 5	GND:PWR singal and GND
C 6	VPP:programming Voltage
C 7	I/O:serial date input/output
C 8	Reserved

G1~G4	GND
CD	CARD DETECTOR



 There should not be any circuits in layout area of the products.

Recommended PCB layout
General Tolerance±0.05

UNLESS OTHERWISE SPECIFIED TOLERANCE				 ATTEND WWW.ATTEND.COM.TW	
UNIT:	DECIMAL	LINEAR	ANGLES		
mm	X.	±0.50	±5°		
	X.X	±0.25	±3°		
	X.XX	±0.12	±1°		
DRAWN	Fros	2014/11/24	DRAWN NAME:		
CHECKED	Ron	2014/11/24	Micro SIM Card Socket push-push type		
APPROVED	Albert	2014/11/24	PRODUCT NO.	115Q-BCA0	
	SCALE 4/1	SHEET 2/4	SIZE A4	FILE NAME	115Q-BCA0_B_5

REV.	DESCRIPTION	DRAWN	DATE
	SEE SHEET 1		

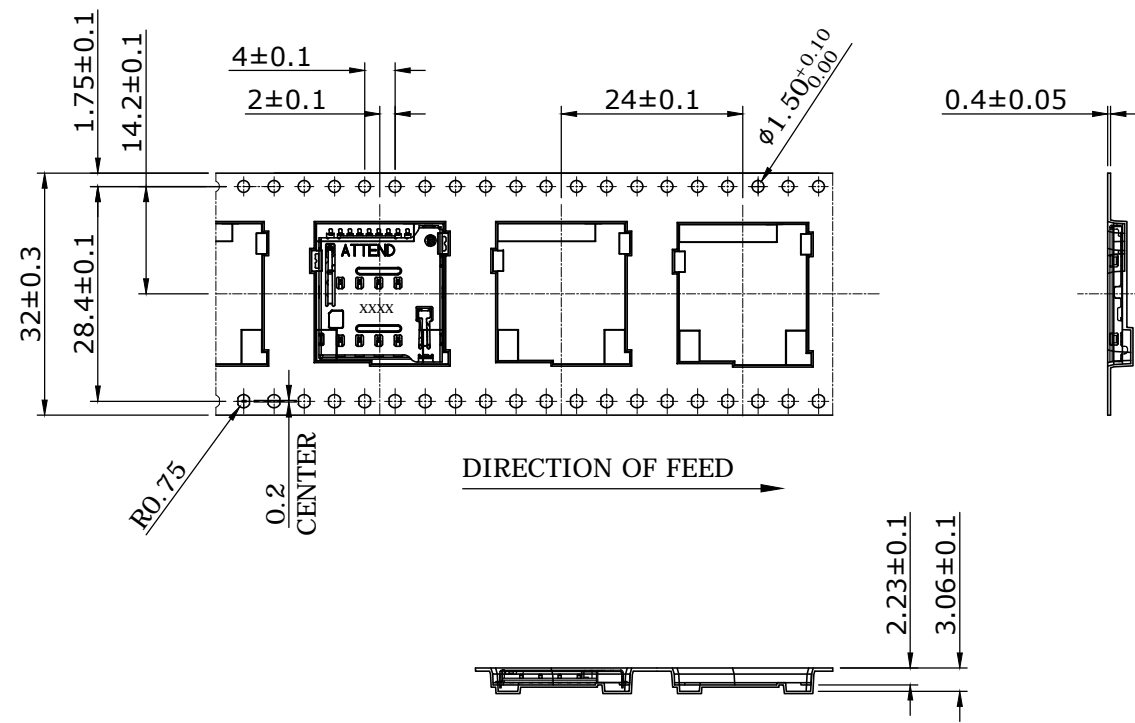
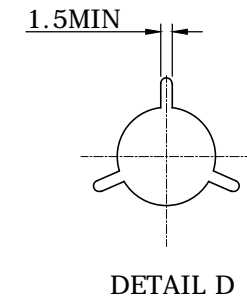
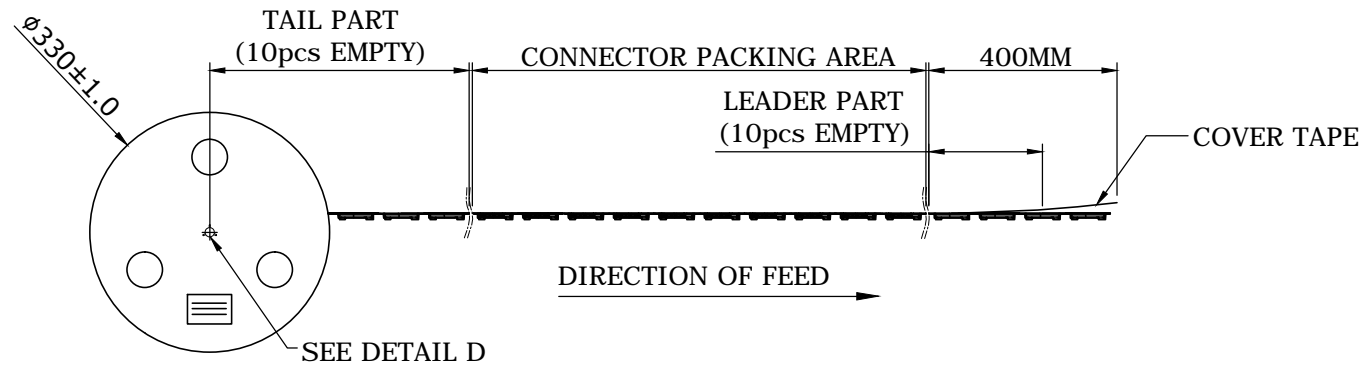

PACKAGING SPECIFICATION:

1. MATERIAL
 - 1.1 Embossed Carrier Tape: PS Black
 - 1.2 Top Cover Tape: PE
20-80g (Peel Speed 300mm/Minute)
 - 1.3 Taping Reel: Plastic Paper
2. PACKING
 - 2.1 Quantity:
800 Piece/Reel
6 Reel/Inner Carton
4800 Piece/Outer Carton
 - 2.2 Net Weight: 0.67g
 - 2.3 Gross Weight: 6.65Kg/Carton

UNLESS OTHERWISE SPECIFIED TOLERANCE				 WWW.ATTEND.COM.TW		
UNIT:	DECIMAL	LINEAR	ANGLES			
mm	X.	±0.50	±5°			
	X.X	±0.25	±3°			
	X.XX	±0.12	±1°			
DRAWN	Fros	2014/11/24	DRAWN NAME: Micro SIM Card Socket push-push type			
CHECKED	Ron	2014/11/24	PRODUCT NO. 115Q-BCA0			
APPROVED	Albert	2014/11/24	FILE NAME	115Q-BCA0_B_5		
SCALE 1/1		SHEET 3/4	SIZE A4			

REV.	DESCRIPTION	DRAWN	DATE
	SEE SHEET 1		

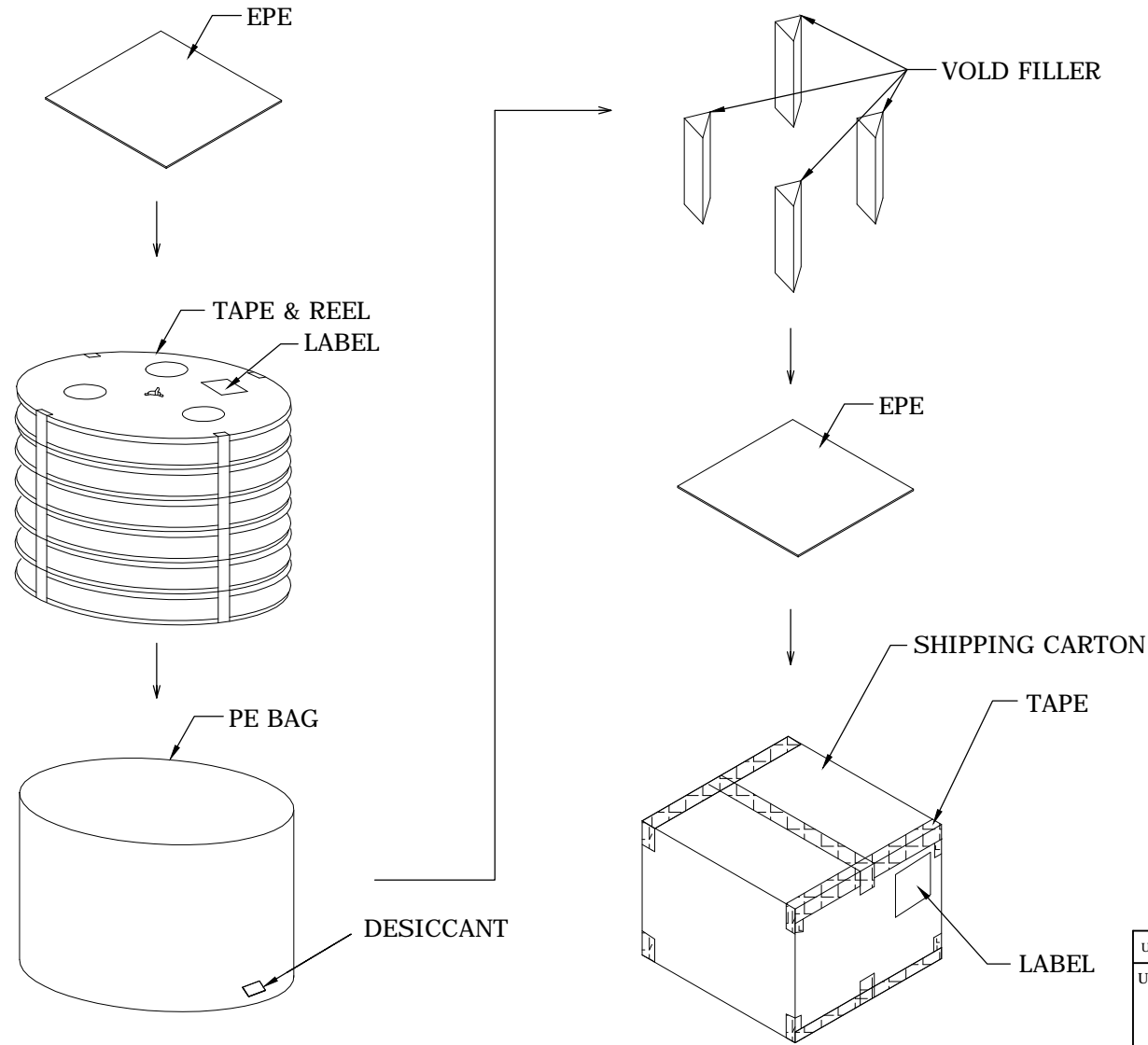

UNLESS OTHERWISE SPECIFIED TOLERANCE			
UNIT:	DECIMAL	LINEAR	ANGLES
mm	X	±0.50	±5°
	X.X	±0.25	±3°
	X.XX	±0.12	±1°



WWW.ATTEND.COM.TW

DRAWN	Fros	2014/11/24	DRAWN NAME:	
CHECKED	Ron	2014/11/24	Micro SIM Card Socket push-push type	
APPROVED	Albert	2014/11/24	PRODUCT NO.	115Q-BCA0
	SCALE N/A	SHEET 4/4	SIZE A4	FILE NAME 115Q-BCA0_B_5