

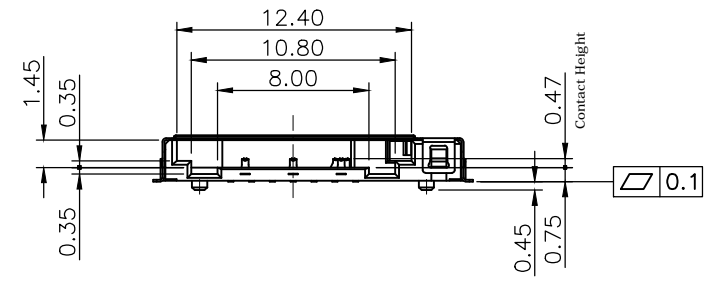

REV.	DESCRIPTION	DRAWN	DATE
1	INITIAL RELEASE	FROS	2020/07/31

DATE CODE: 0151 (YWWD)
 Y= YEAR(2020)
 WW= WEEK(01-52)
 D= DAY(1-7)

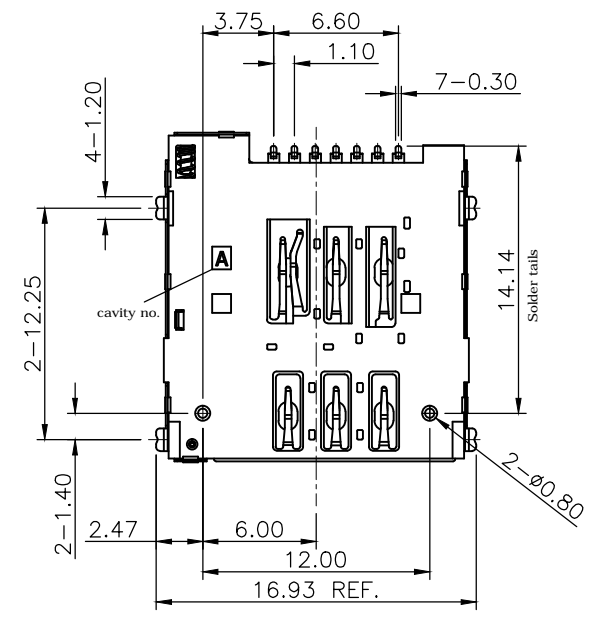
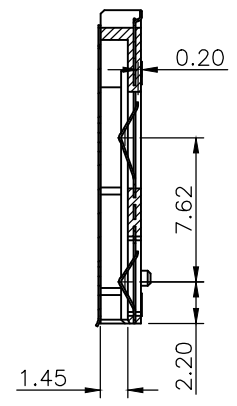
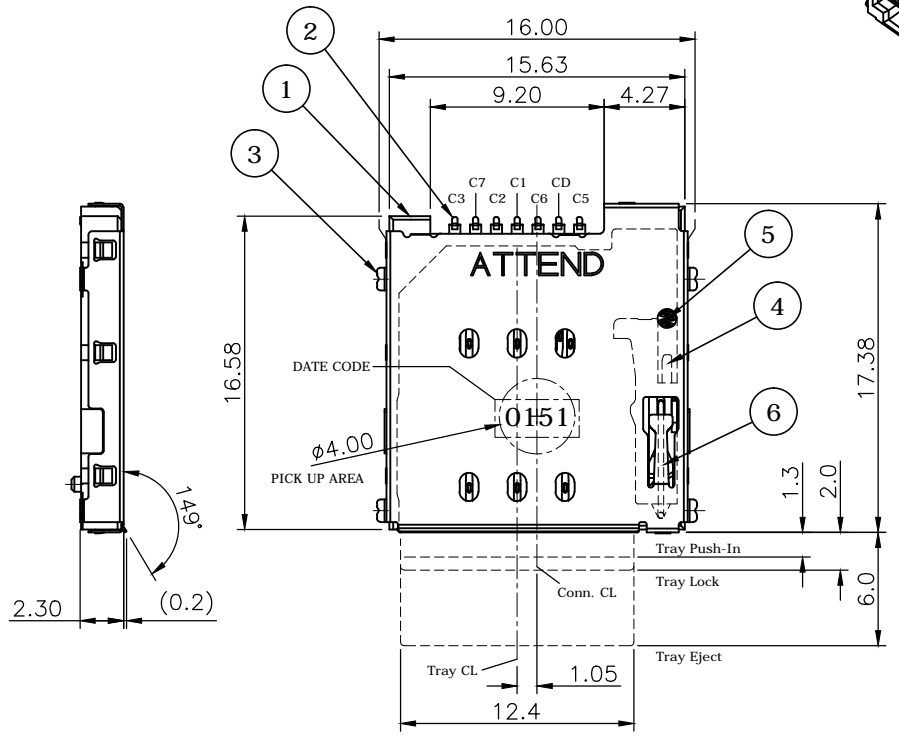
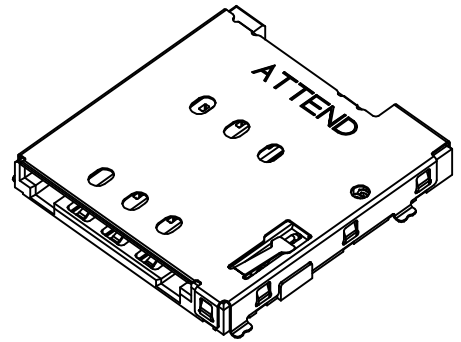

This part is a connector only, it should be used together with Nano SIM Tray P/N: 115U-T001

UNLESS OTHERWISE SPECIFIED TOLERANCE					
UNIT:	DECIMAL	LINEAR	ANGLES		
mm	X.	±0.50	±5°	www.attend.com.tw	
	X.X	±0.25	±3°		
	X.XX	±0.12	±1°		
DRAWN	Fros	2020/04/06	DRAWN NAME:		
CHECKED	Tim	2020/04/06	Nano SIM Socket, 6 Pin, Tray-Push Push, G/F, Reel		
APPROVED	Ken	2020/04/06	PRODUCT NO.	115U-A101	
SCALE	2.5/1	SHEET	1/4	SIZE	A4
			FILE NAME	115U-A101_B_1	

REV.	DESCRIPTION	DRAWN	DATE
	see sheet one		

Pin out & Card detect switch status.

Pin NO.	Pin Name
C 1	VCC
C 2	RST
C 3	CLK
C 5	GND
C 6	VPP
C 7	I/O
CD	Card Detect Switch

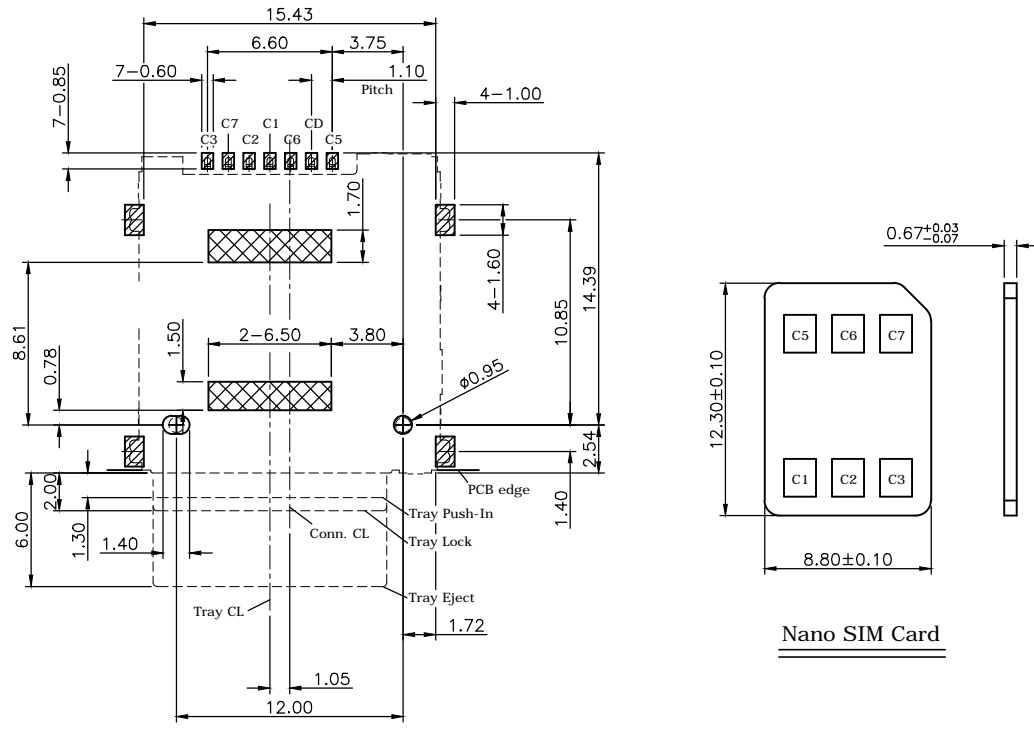
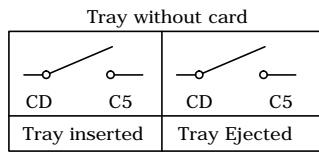
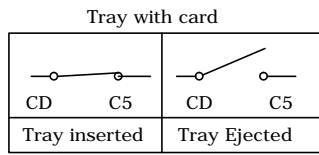

Recommended PCB layout (top view)
General tolerance: ±0.05mm

SPECIFICATION:

- ELECTRICAL**
 - Current Rating: 0.5A per pin
 - Voltage Rating: 10V DC
 - Contact Resistance: Initial 50mΩ, after 100mΩ Max.
 - Insulation Resistance: 1000MΩ
 - Dielectric Withstanding Voltage: 500VAC
- MECHANICAL**
 - Durability: 5,000 cycles
 - Contact Normal Force: 0.3N Min. per pin
 - Tray Withdrawal Force: 2N Min.
- ENVIRONMENTAL**
 - Operating temperature range: -40°C~+85°C
 - Storage temperature range: -40°C~+85°C
- SOLDER ABILITY**
 - Recommended IR-Reflow Temperature: 260°C

This part is a connector only, it should be used together with Nano SIM Tray P/N: 115U-T001

*	115U-T001	Card Tray, Used for Nano SIM Card Socket Push-Push, Lock, PC+ABS, Black, Reel
---	-----------	---

6	CRANK	Stainless Steel
5	SPRING	SWP-B, Nickel plating
4	SLIDER	LCP, UL94V-0, Black
3	SHELL	Stainless Steel, Nickel plating
2	CONTACT	Phosphor Bronze, Gold plating over Nickel
1	HOUSING	LCP, UL94V-0, Black

NO.	PART NAME	DESCRIPTION	
UNLESS OTHERWISE SPECIFIED TOLERANCE			
UNIT:	DECIMAL	LINEAR	ANGLES
	mm	X. ±0.50	±5°
		X.X ±0.25	±3°
		X.XX ±0.12	±1°
www.attend.com.tw			
DRAWN	Fros	2020/04/06	
CHECKED	Tim	2020/04/06	
APPROVED	Ken	2020/04/06	
DRAWN NAME:		Nano SIM Socket, 6 Pin, Tray-Push Push, G/F, Reel	
PRODUCT NO.	115U-A101		
SCALE	SHEET	SIZE	
2.5/1	2/4	A4	
FILE NAME	115U-A101_B_1		



REV.	DESCRIPTION	DRAWN	DATE
	see sheet one		

Instruction Manual

A. Set up Nano SIM card

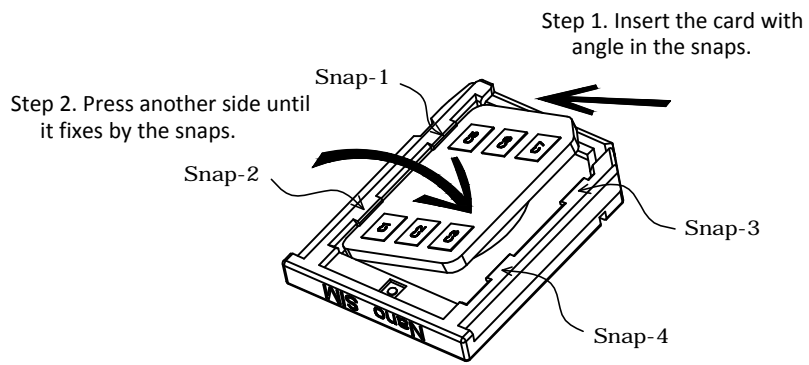

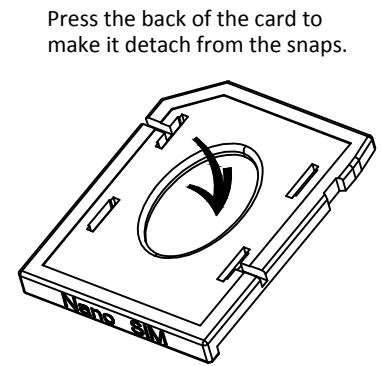

B. Remove Nano SIM card

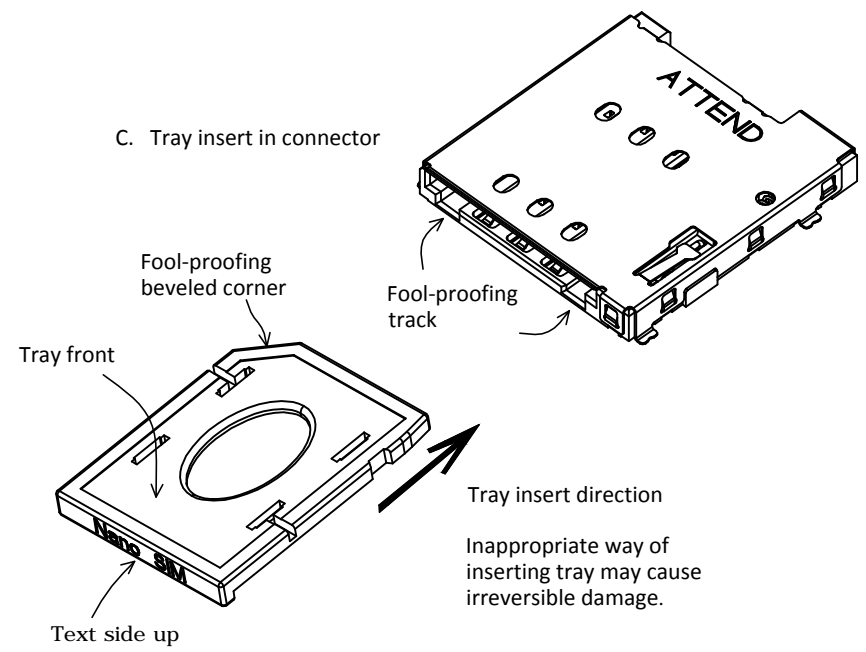

C. Tray insert in connector



UNLESS OTHERWISE SPECIFIED TOLERANCE					
UNIT:	DECIMAL	LINEAR	ANGLES		
mm	X.	±0.50	±5°	www.attend.com.tw	
	X.X	±0.25	±3°		
	X.XX	±0.12	±1°		
DRAWN	Fros	2020/04/06	DRAWN NAME: Nano SIM Socket, 6 Pin, Tray-Push Push, G/F, Reel		
CHECKED	Tim	2020/04/06	PRODUCT NO. 115U-A101		
APPROVED	Ken	2020/04/06	FILE NAME 115U-A101_B_1		
		SCALE 2.5/1	SHEET 3/4	SIZE A4	

REV.	DESCRIPTION	DRAWN	DATE
	see sheet one		

Instruction Manual

Recommended Panel Cut

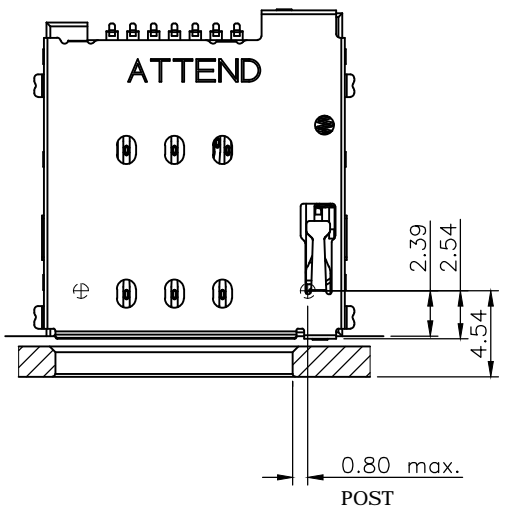

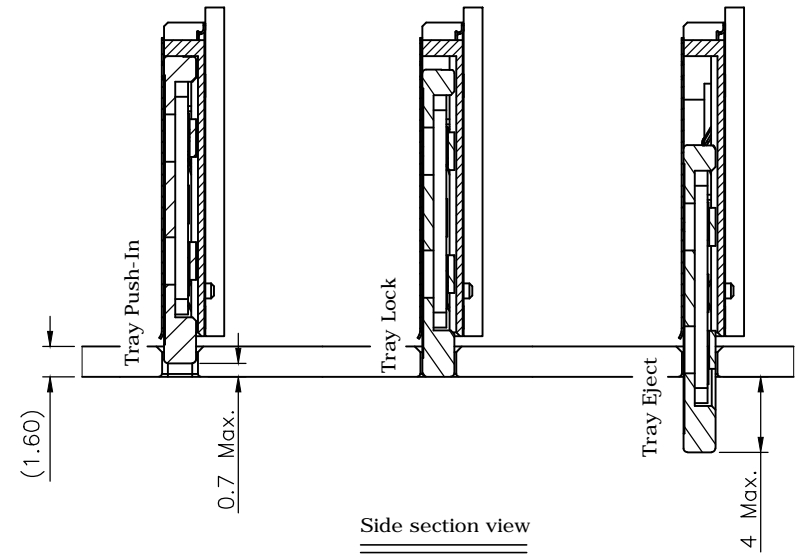

Top view

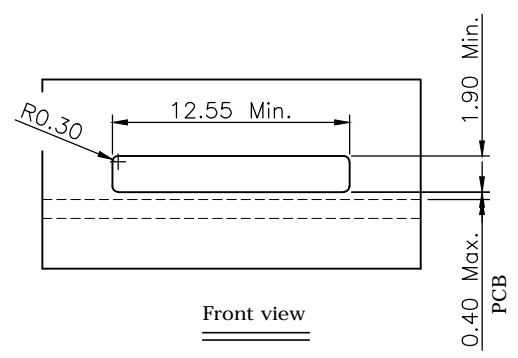

Side section view



Front view

UNLESS OTHERWISE SPECIFIED TOLERANCE				 www.attend.com.tw
UNIT:	DECIMAL	LINEAR	ANGLES	
mm	X.	±0.50	±5°	
	X.X	±0.25	±3°	
	X.XX	±0.12	±1°	
DRAWN	Fros	2020/04/06	DRAWN NAME:	
CHECKED	Tim	2020/04/06	Nano SIM Socket, 6 Pin, Tray-Push Push, G/F, Reel	
APPROVED	Ken	2020/04/06	PRODUCT NO. 115U-A101	
	SCALE 2.5/1	SHEET 4/4	SIZE A4	FILE NAME 115U-A101_B_1

REV.	DESCRIPTION	DRAWN	DATE
1	INITIAL RELEASE	FROS	2020/04/06

PACKAGING SPECIFICATION:

- 1. MATERIAL
 - 1.1 Embossed Carrier Tape: PS Black
 - 1.2 Top Cover Tape: PET 20-80g(Peel Speed 300mm/Minute)
 - 1.3 Taping Reel: Paper
- 2. PACKING
 - 2.1 Quantity:
 - 700 Piece/Reel
 - 4,200 Piece/Carton

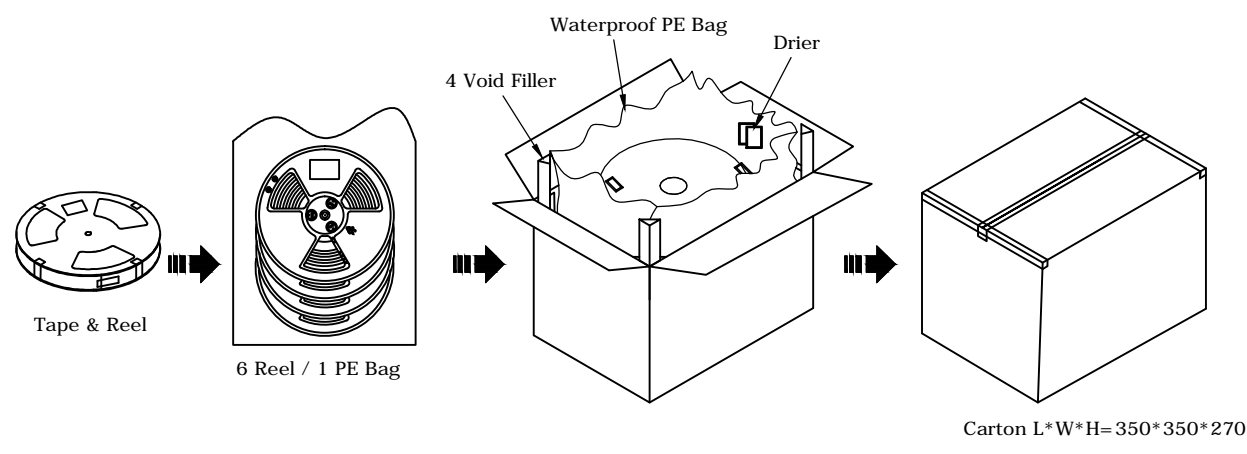
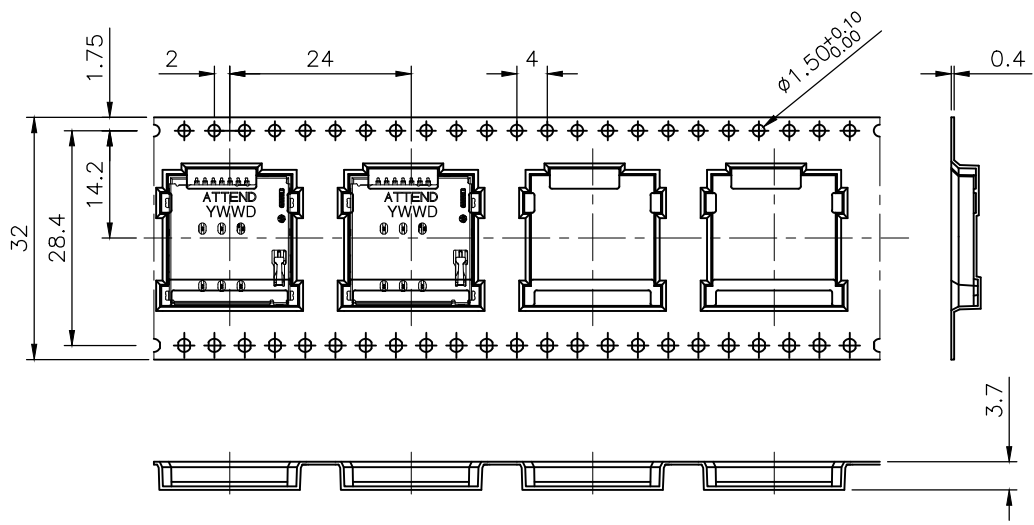
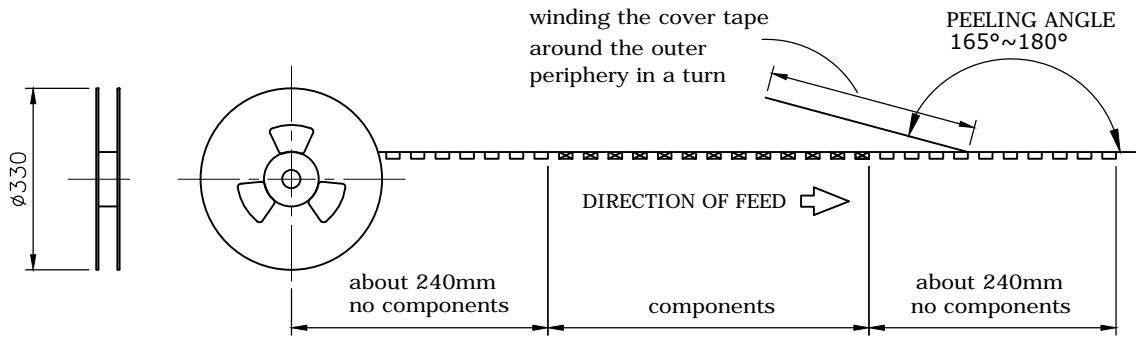

UNLESS OTHERWISE SPECIFIED TOLERANCE

UNIT:	DECIMAL	LINEAR	ANGLES
mm	X.	±0.50	±5°
	X.X	±0.25	±3°
	X.XX	±0.12	±1°



DRAWN	Fros	2020/04/06	DRAWN NAME:	www.attend.com.tw
CHECKED	Tim	2020/04/06	Nano SIM Socket, 6 Pin, Tray-Push Push, G/F, Reel	
APPROVED	Ken	2020/04/06	PRODUCT NO.	115U-A101
	SCALE	SHEET	SIZE	FILE NAME
	1/1	1/1	A4	115U-A101_D_1

REV.	DESCRIPTION	DRAWN	DATE
1	INITIAL RELEASE	FROS	2020/04/29

NOTE:

- MATERIAL: PC/ABS, UL 94V-0 Rated, Color black.
- RoHS + HF COMPLIANT PRODUCTS.

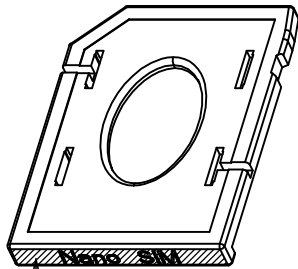
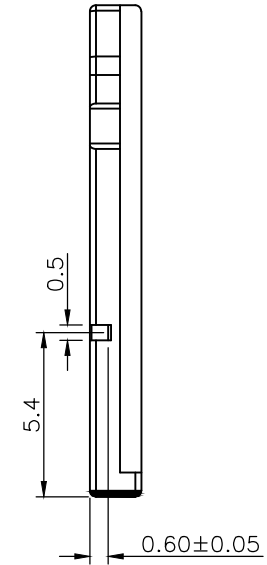
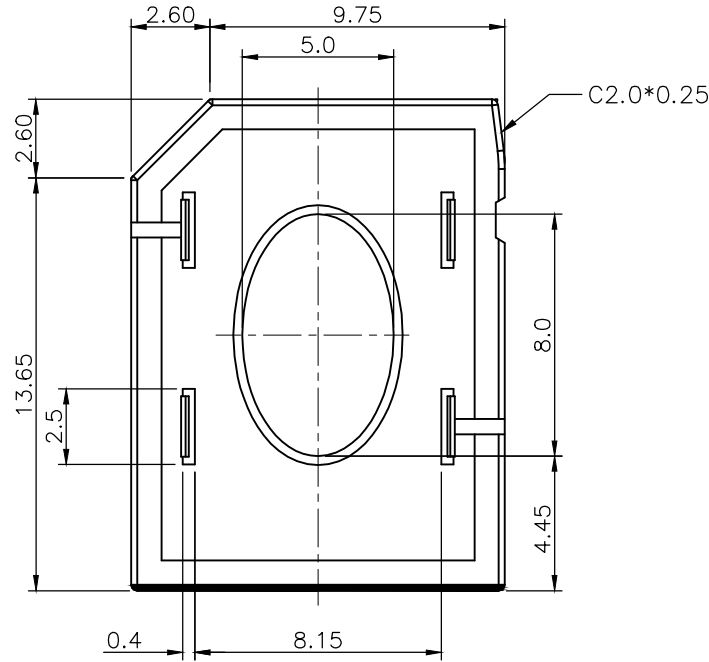
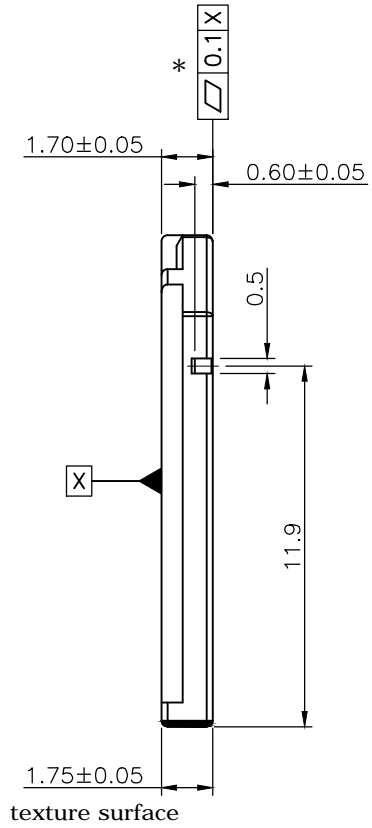

Finish:
Surface texture : MT-1055-1
Text: transparent clean, depth 0.3mm max.

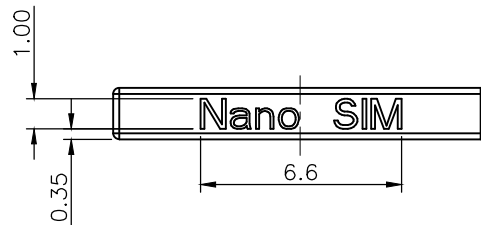

UNLESS OTHERWISE SPECIFIED TOLERANCE			
UNIT:	DECIMAL	LINEAR	ANGLES
mm	X.	±0.50	±5°
	X.X	±0.25	±3°
	X.XX	±0.12	±1°



www.attend.com.tw

DRAWN	Fros	2020/04/27	DRAWN NAME:	
CHECKED	Tim	2020/04/27	Nano SIM Card Tray, Used for 115U-A101, Reel	
APPROVED	Ken	2020/04/27	PRODUCT NO.	115U-T001
SCALE	4/1	SHEET	1/2	SIZE
				A4
FILE NAME			115U-T001_B_1	

REV.	DESCRIPTION	DRAWN	DATE
	see sheet one		

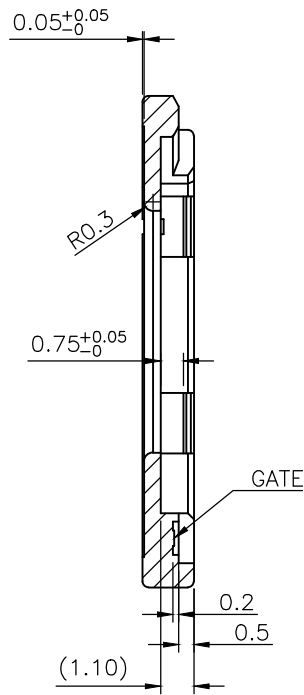
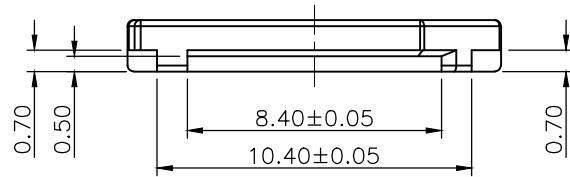
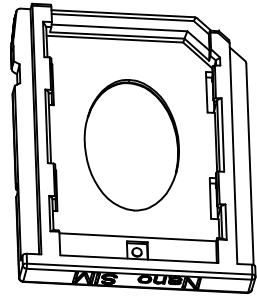

SECTION A-A

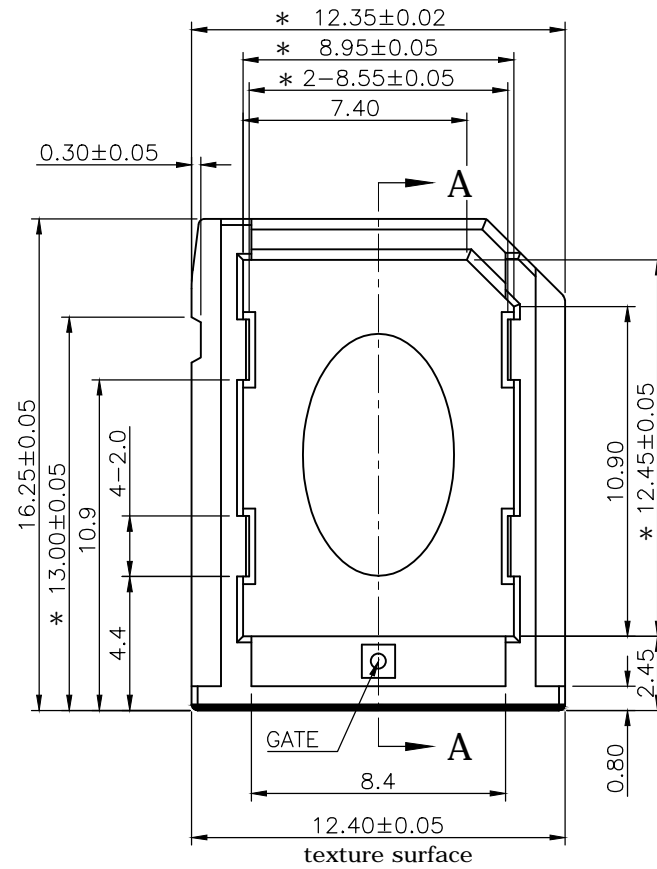

UNLESS OTHERWISE SPECIFIED TOLERANCE

UNIT:	DECIMAL	LINEAR	ANGLES
mm	X.	±0.50	±5°
	X.X	±0.25	±3°
	X.XX	±0.12	±1°



www.attend.com.tw
 DRAWN NAME:
 Nano SIM Card Tray,
 Used for 115U-A101, Reel

DRAWN	Fros	2020/04/27	DRAWN NAME:	
CHECKED	Tim	2020/04/27	PRODUCT NO.	115U-T001
APPROVED	Ken	2020/04/27	FILE NAME	115U-T001_B_1
SCALE	4/1	SHEET	2/2	SIZE
				A4

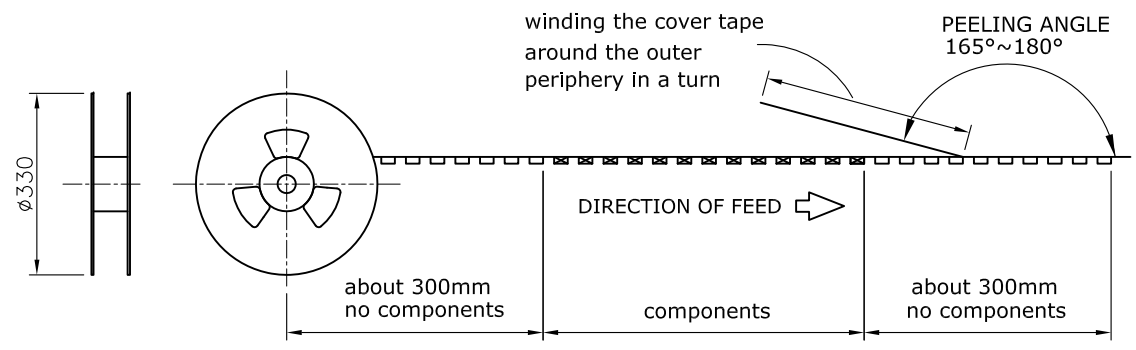

REV.	DESCRIPTION	DRAWN	DATE
1	INITIAL RELEASE	FROS	2020/04/27

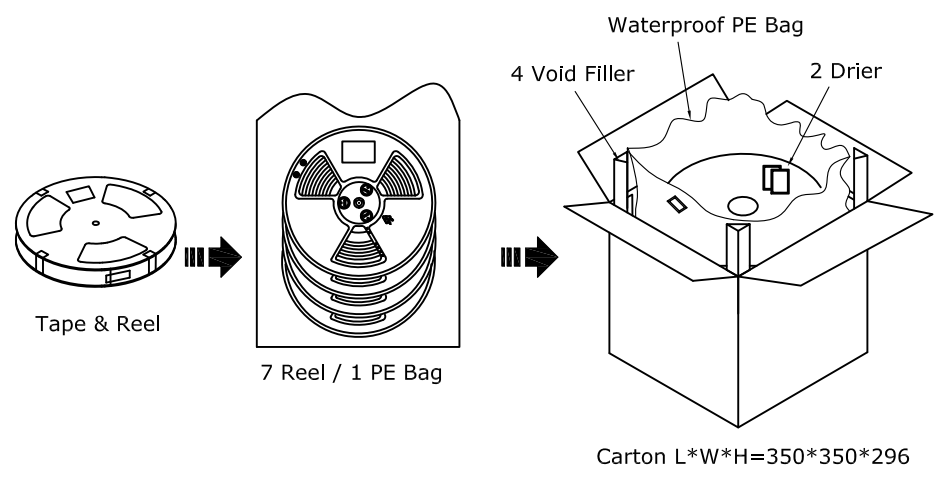
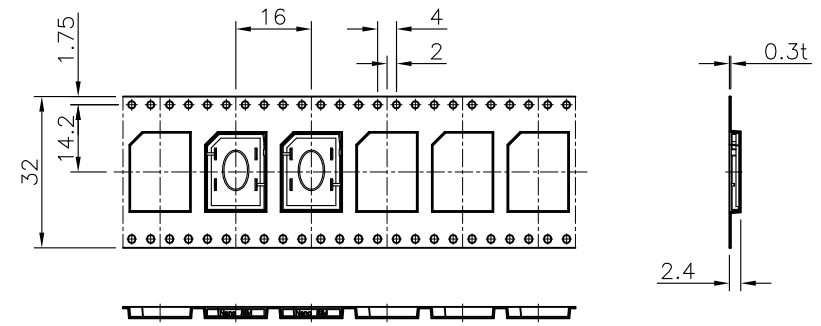

PACKAGING SPECIFICATION:

1. MATERIAL
 - 1.1 Embossed Carrier Tape: PS Black
 - 1.2 Top Cover Tape: PET
20-80g(Peel Speed 300mm/Minute)
 - 1.3 Taping Reel: Plastic
2. PACKING
 - 2.1 Quantity:
1,800 Piece/Reel
12,600 Piece/Carton



UNLESS OTHERWISE SPECIFIED TOLERANCE					
UNIT:	DECIMAL	LINEAR	ANGLES		
mm	X.	±0.50	±5°	www.attend.com.tw	
	X.X	±0.25	±3°		
	X.XX	±0.12	±1°		
DRAWN	Fros	2020/04/27	DRAWN NAME:		
CHECKED	Tim	2020/04/27	Card Tray, Used for Nano SIM Card Socket		
APPROVED	Ken	2020/04/27	PRODUCT NO.	115U-T001	
	SCALE 0.625	SHEET 1/1	SIZE A4	FILE NAME	115U-T001_D_1