

1
RoHS Compliance

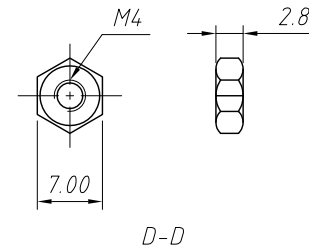
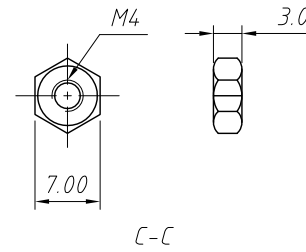
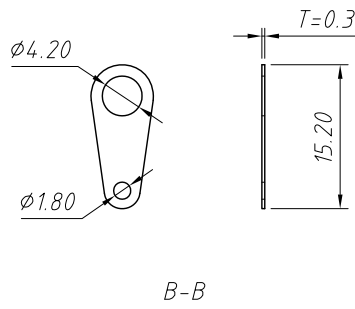
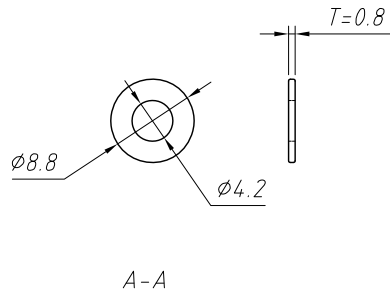
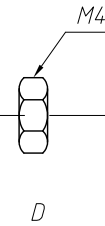
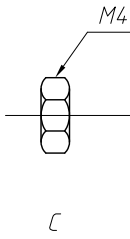
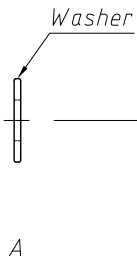
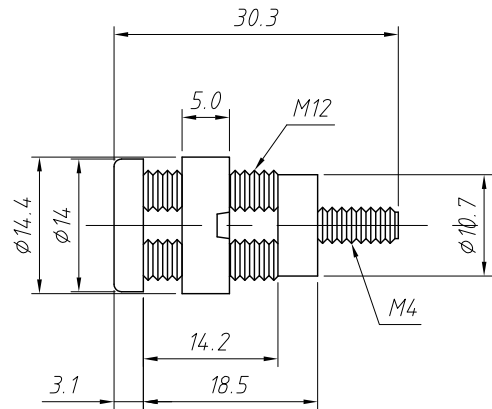

Order Information:

L-KLS1-BIP-043-R

Color: R=Red Color B=Black Color

Serial number

Banana Jack

Part NO

RoHS

ANGLE TOLERANCE	PROJECTION	Description:		
±3°		Safety banana socket		
GENERAL TOLERANCE	UNITS	mm	KLS P/N:	L-KLS1-BIP-043-R
x.x ±0.30	SHEET SIZE	A4	1:1.5	NingBo KLS ELECTRONIC CO.,L TD.
x.xx ±0.20	Draw:	Jenny	2019-07-10	
x.xxx ±0.10	Check:	Daniel	2019-07-10	