

The information provided herein is from CONNELY Electronic Co., Ltd. and is confidential. Any disclosure to a party other than the recipient is prohibited. The intellectual properties and its rights contained herein, including but not limited to, trademarks, patents, copyrights, trade secrets, and technical know-how, are owned exclusively by CONNELY or its affiliates. Unauthorized use or reproduction of any part of this document is strictly prohibited. CONNELY may enforce its intellectual property rights at its own discretion, failures or delays to exercise such rights does not constitute a waiver of such rights.

REV.	DESCRIPTION	DRAWN	CHECKED	APPROVED
A	NEW RELEASE	YCH 06/27/08'		LJC 06/27/08'
D	DRAWING UPDATE	JLZ 04/28/20'		

Male Right Angle

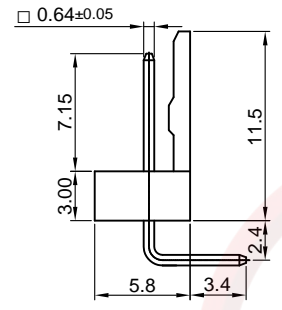
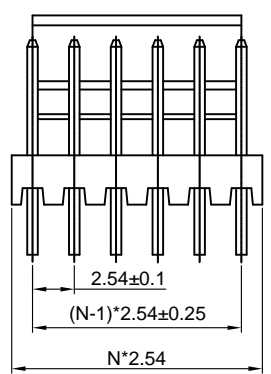

Type A

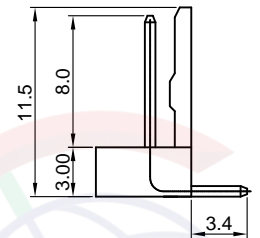

Type B

Male V/T type

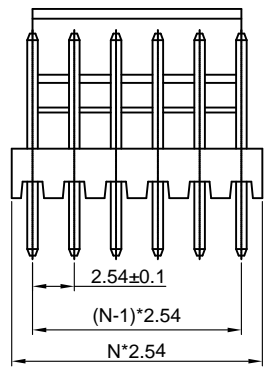

N=Number Of Contacts

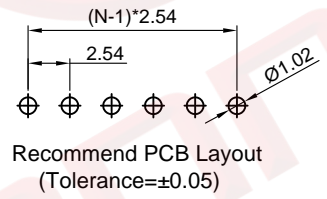
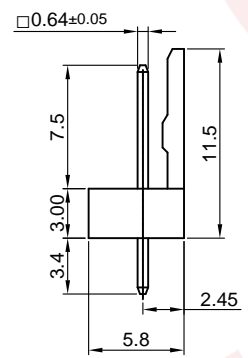

Recommend PCB Layout
(Tolerance=±0.05)



(Series Image-Reference Only)

Notes:

- Electrical Characteristics:
 - Contact Resistance: 30mΩ Max.
 - Dielectric Withstanding Voltage: 600V AC(rms) For 1 Minute.
 - Insulation Resistance: 1000MΩ Min.
 - Current Rating:3A.
- Environment Characteristics:
 - Temperature: -25°C~+85°C.
- Materials:
 - Contact Material: Copper Alloy.
 - Contact Plating: Tin Plating Over Nickel.
 - Insulator Materials: Nylon.

4.Product Number Code:

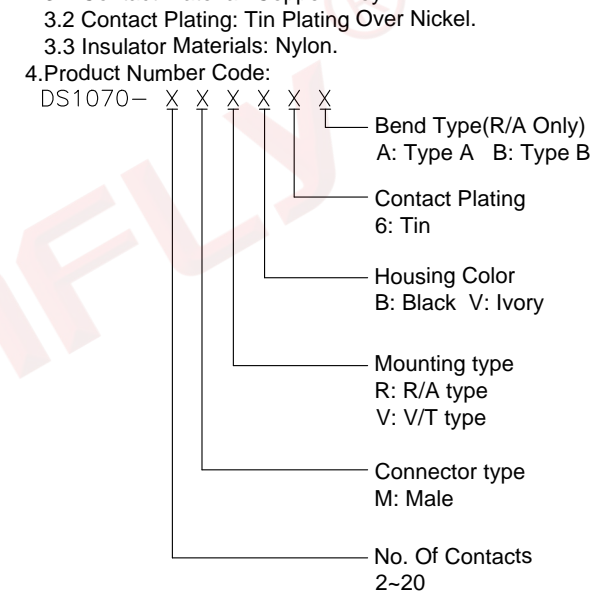

GENERAL TOLERANCE		ANGLE TOLERANCE		PROJECTION		TITLE	
X.	±0.60	X.	±5°	UNITS	mm	2.54mm Wafer 2510 Type	
.X	±0.38	.X	±3°	SHEET SIZE	A4	SERIES	DS1070 SERIES
.XX	±0.25	.XX	±2°	晨翔电子有限公司 CONNELY CONNELY ELECTRONIC CO. LTD			
DRAWING TYPE		CUSTOMER					
SCALE	1:1	SHEET	1 OF 2				
DRAWING NO.		C-DS1070-XXXXXX-D					

Dept	
Qty	
DC	1
ED	1
IE	1
ISO	1
PD	1
R&D	1
SD	1
QA	1
QC	1
QE	1

The information provided herein is from CONNELY Electronic Co., Ltd. and is confidential. Any disclosure to a party other than the recipient is prohibited. The intellectual properties and its rights contained herein, including but not limited to, trademarks, patents, copyrights, trade secrets, and technical know-how, are owned exclusively by CONNELY or its affiliates. Unauthorized use or reproduction of any part of this document is strictly prohibited. CONNELY may enforce its intellectual property rights at its own discretion, failures or delays to exercise such rights does not constitute a waiver of such rights.

REV.	DESCRIPTION	DRAWN	CHECKED	APPROVED
A	NEW RELEASE	YCH 06/27/08'		LJC 06/27/08'
D	DRAWING UPDATE	JLZ 04/28/20'		

Female Terminal

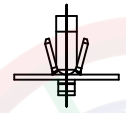
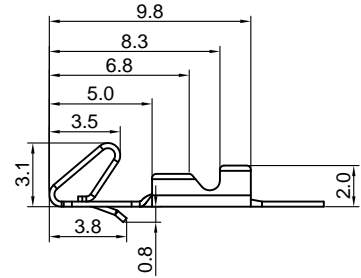

Female Terminal

Wire Range	
Section Area (mm) ²	AWG#
0.09~0.34	28~22

Female Housing

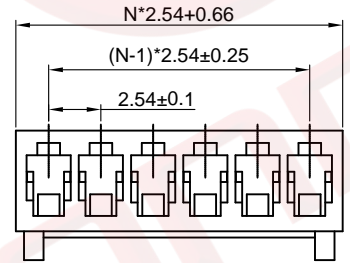
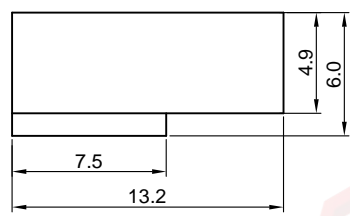

(Series Image-Reference Only)

Notes:

- Electrical Characteristics:
 - Contact Resistance: 30mΩ Max.
 - Dielectric Withstanding Voltage: 600V AC(rms) For 1 Minute.
 - Insulation Resistance: 1000MΩ Min.
 - Current Rating:3A.
- Environment Characteristics:
 - Temperature: -25°C~+85°C.
- Materials:
 - Contact Material: Copper Alloy.
 - Contact Plating: Tin Plating Over Nickel.
 - Insulator Materials: Nylon.
- Product Number Code:

Female Housing:

I - DS1070 - S C X XX
 No. of contact: 02 to 20
 Housing Color: Ivory
 V: Ivory

Female Terminal:

T - DS1070 - S C X 0 0
 Contact Plating: 6: Tin

GENERAL TOLERANCE		ANGLE TOLERANCE		PROJECTION		TITLE	
X.	±0.60	X.	±5°	UNITS	mm	2.54mm Terminal & Housing 2510 Type	
.X	±0.38	.X	±3°	SHEET SIZE	A4	SERIES	DS1070 SERIES
.XX	±0.25	.XX	±2°	晨翔电子有限公司 CONNFLY CONNELY ELECTRONIC CO. LTD			
DRAWING TYPE		CUSTOMER					
SCALE	1:1	SHEET	2 OF 2				
DRAWING NO.		C-DS1070-XXXXXX-D					

REV.	DESCRIPTION	DRAWN	CHECKED	APPROVED
A	NEW RELEASE	LJC 07/19/05'	~	

- Notes:
- 1.Materials: Phosphor Bronze.
 - 2.Packing Type: Reel Paper, 9Kpcs/Reel.
 - 3.Wire range:22~28AWG
 - 4.Part Number Code:
T - DS1070 - S C X 0 0

Plating:
6: Full Tin(pre-plating).

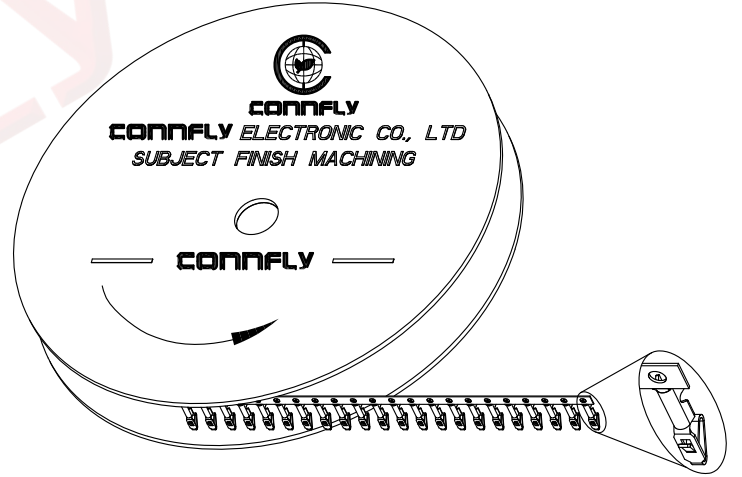
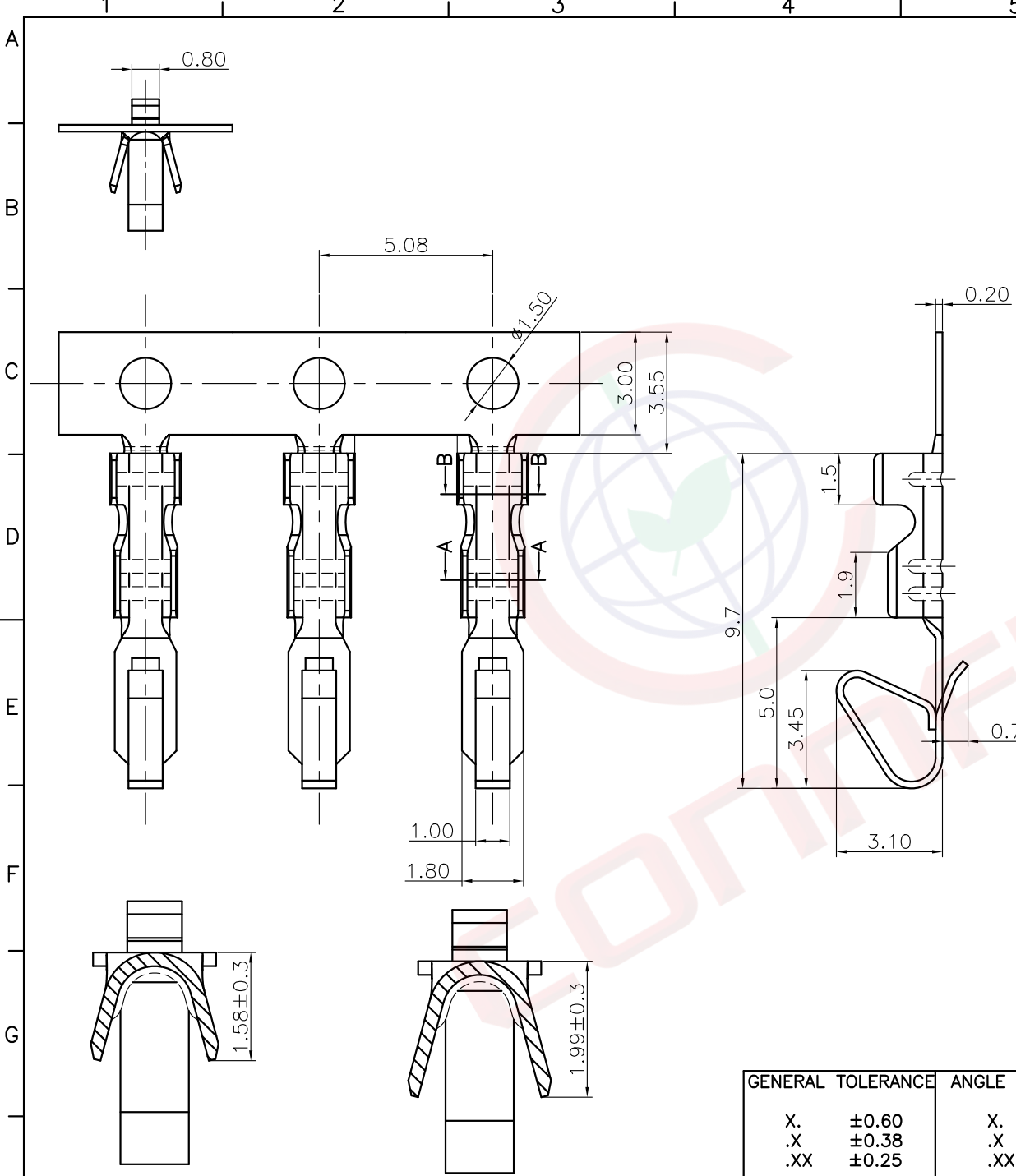

SECTION A-A(scale 2:1)

SECTION B-B(scale 2:1)

GENERAL TOLERANCE		ANGLE TOLERANCE	
X.	±0.60	X.	±5°
.X	±0.38	.X	±3°
.XX	±0.25	.XX	±2°

PROJECTION	TITLE
mm	DS1070 CONTACT
SHEET SIZE	SERIES
A4	DS1070 SERIES

DRAWING TYPE	CUSTOMER		
SCALE	1:1	SHEET	1 OF 1
DRAWING NO.	T-DS1070-SCX00-A		

晨翔电子有限公司
 CONNFLY ELECTRONIC CO., LTD