

CONNECTORS MANUFACTURER

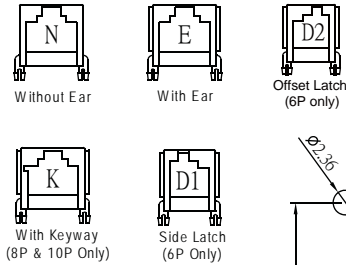

Modular Jack Side Entry H=14.5 W=15.0

Material&Finish
Housing: P.B.T, UL 94V-0
Contact :0.45mm Thickness Phosphor Bronze,
Gold Plated Over Nickel on Contact Area.

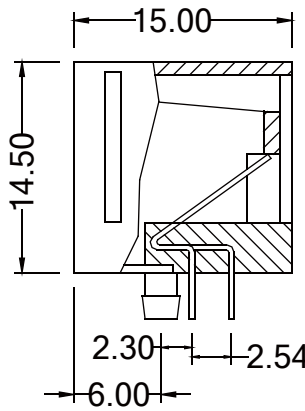
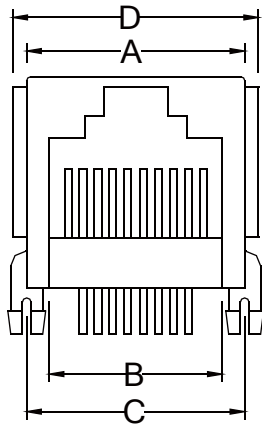

Positions	Contacts	A	B	C	D
4P	4C	10.00	7.85	10.00	12.00
(6P)4P	4C	12.20	7.85	12.00	14.20
6P	2C/4C/6C	12.20	9.90	12.00	14.20
8P	8C	15.00	11.85	15.00	16.90
10P	10C	15.00	11.85	15.00	16.90

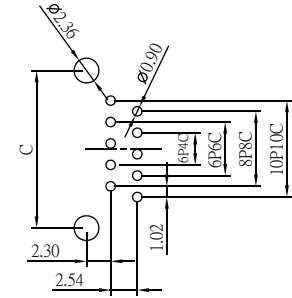

Recommended PCB Layout
(PCB TOLERANCE ±0.05)

Order Information

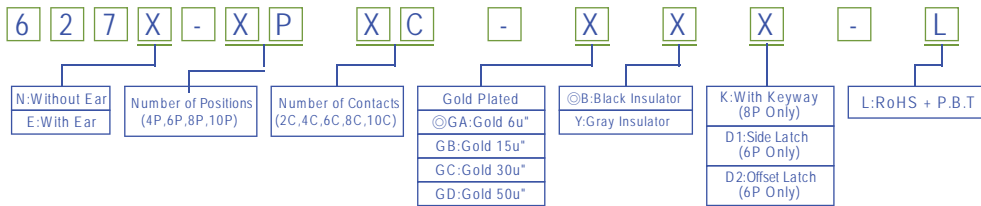

Modular Jack Side Entry H=14.5 W=13.10

Material&Finish
Housing:Glass Fiber, P.B.T, UL 94V-0
Contact :0.45mm Thickness Phosphor Bronze,
Gold Plating Over Nickel on Contact Area.

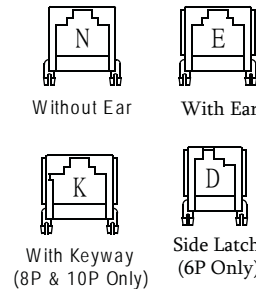
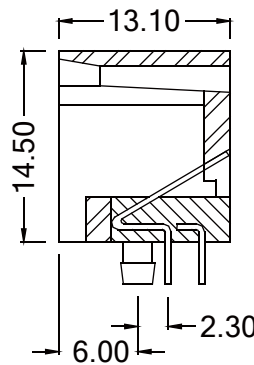
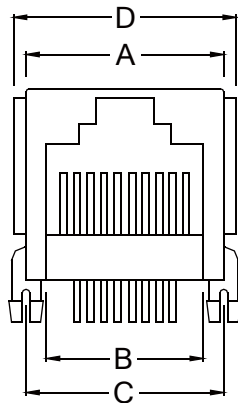

Positions	Contacts	A	B	C	D
4P	4C	10.00	7.85	10.00	12.00
(6P)4P	4C	12.20	7.85	12.00	14.20
6P	2C/4C/6C	12.20	9.90	12.00	14.20
8P	8C	15.00	11.85	15.00	16.90
10P	10C	15.00	11.85	15.00	16.90

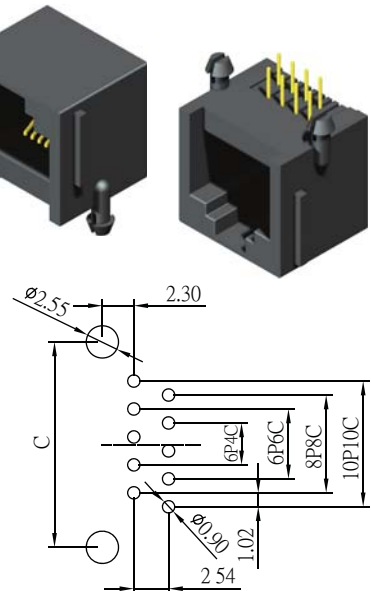

Recommended PCB Layout
(PCB TOLERANCE ±0.05)

Order Information

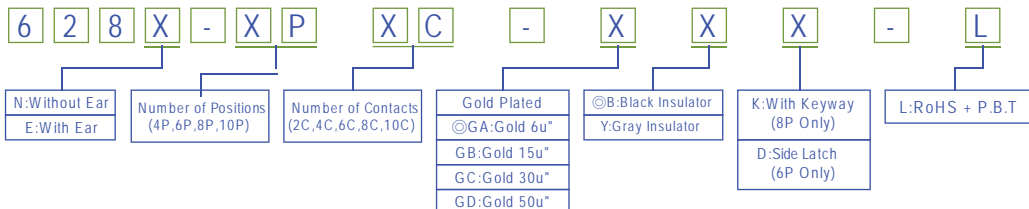

Modular Jack

RoHS

CONNECTOR MANUFACTURER