

# TRIAC(Through Hole / Isolated)

# TMG20CQ60F 5

(T<sub>j</sub>=150°C)

SanRex Triac TMG20CQ60F 5 is designed for full wave AC control applications. It can be used as an ON/OFF function or for phase control operation.

## Typical Applications

- Home Appliances : Washing Machines, Vacuum Cleaners, Rice Cookers, Micro Wave Ovens, Hair Dryers, other control applications
- Industrial Use : SMPS, Copier Machines, Motor Controls, Dimmer, SSR, Heater Controls, Vending Machines, other control applications

## Features

- I<sub>T(RMS)</sub>=20A
- High Surge Current
- Low Voltage Drop

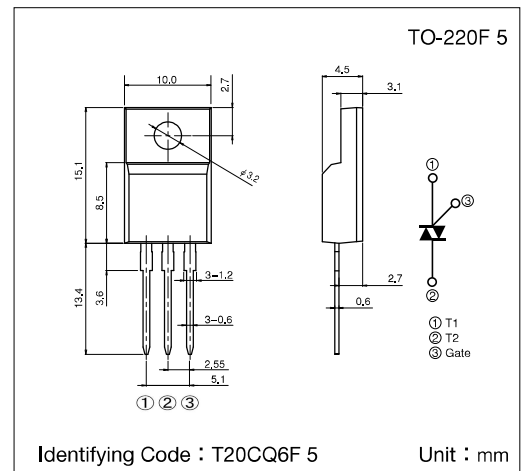

## Maximum Ratings

(T<sub>j</sub>=25°C unless otherwise specified)

Symbol	Item	Reference	Ratings	Unit
V <sub>DRM</sub>	Repetitive Peak Off-State Voltage		600	V
I <sub>T(RMS)</sub>	R.M.S. On-State Current	T <sub>c</sub> =91°C	20	A
I <sub>TSM</sub>	Surge On-State Current	One cycle, 50Hz/60Hz, Peak value, non-repetitive	183/200	A
I <sup>2</sup> t	I <sup>2</sup> t (for fusing)		165	A <sup>2</sup> s
P <sub>GM</sub>	Peak Gate Power Dissipation		5	W
P <sub>G(AV)</sub>	Average Gate Power Dissipation		0.5	W
I <sub>GM</sub>	Peak Gate Current		2	A
V <sub>GM</sub>	Peak Gate Voltage		10	V
V <sub>ISO</sub>	Isolation Breakdown Voltage (R.M.S.)	A.C. 1minute	1500	V
T <sub>j</sub>	Operating Junction Temperature		-40~+150	°C
T <sub>stg</sub>	Storage Temperature		-40~+150	°C
	Mass		2	g

## Electrical Characteristics

Symbol	Item	Reference	Ratings			Unit
			Min.	Typ.	Max.	
I <sub>DRM</sub>	Repetitive Peak Off-State Current	V <sub>D</sub> =V <sub>DRM</sub> , Single phase, half wave, T <sub>j</sub> =150°C			3	mA
V <sub>TM</sub>	Peak On-State Voltage	I <sub>T</sub> =30A, Inst. measurement			1.4	V
I <sub>GT1</sub> <sup>+</sup>	Gate Trigger Current	V <sub>D</sub> =6V, R <sub>L</sub> =10Ω			30	mA
I <sub>GT1</sub> <sup>-</sup>					30	
I <sub>GT3</sub> <sup>+</sup>					—	
I <sub>GT3</sub> <sup>-</sup>					30	
V <sub>GT1</sub> <sup>+</sup>	Gate Trigger Voltage				1.5	V
V <sub>GT1</sub> <sup>-</sup>					1.5	
V <sub>GT3</sub> <sup>+</sup>					—	
V <sub>GT3</sub> <sup>-</sup>					1.5	
V <sub>GD</sub>	Non-Trigger Gate Voltage	T <sub>j</sub> =150°C, V <sub>D</sub> =1/2V <sub>DRM</sub>	0.1			V
(dv/dt) <sub>c</sub>	Critical Rate of Rise of Off-State Voltage at Commutation	T <sub>j</sub> =150°C, (di/dt) <sub>c</sub> =-10A/ms, V <sub>D</sub> =2/3V <sub>DRM</sub>	5			V/μs
I <sub>H</sub>	Holding Current			25		mA
R <sub>th</sub>	Thermal Resistance	Junction to case			2.5	°C/W

Trigger mode of the triac

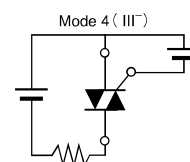
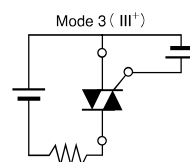
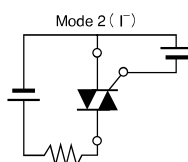
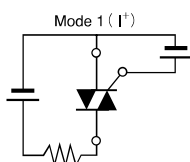

### Gate Characteristics

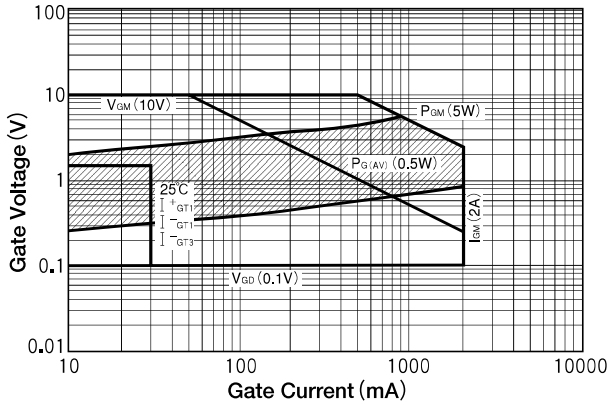

### On-State Characteristics (MAX)

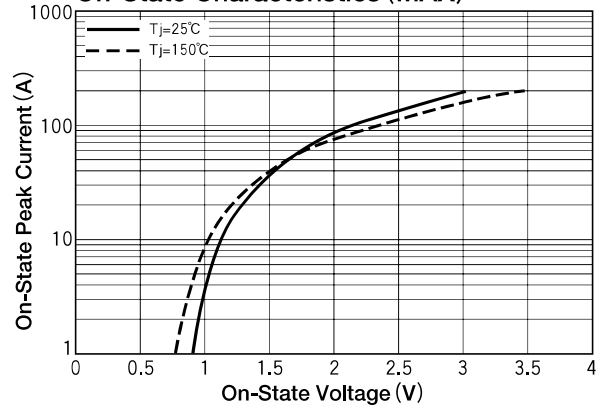

### R.M.S. On-State Current vs Maximum Power Dissipation

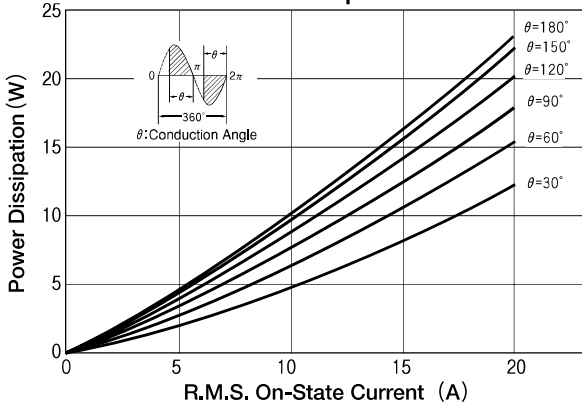

### R.M.S. On-State Current vs Allowable Case Temperature

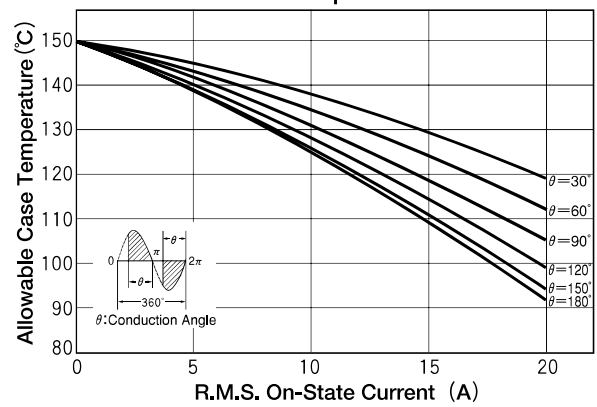

### Surge On-State Current Rating (Non-Repetitive)

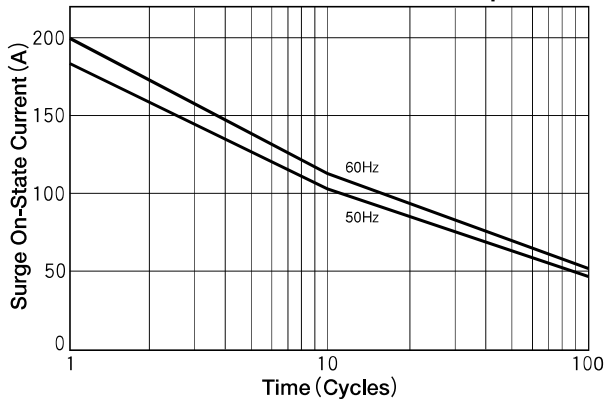

### Transient Thermal Impedance

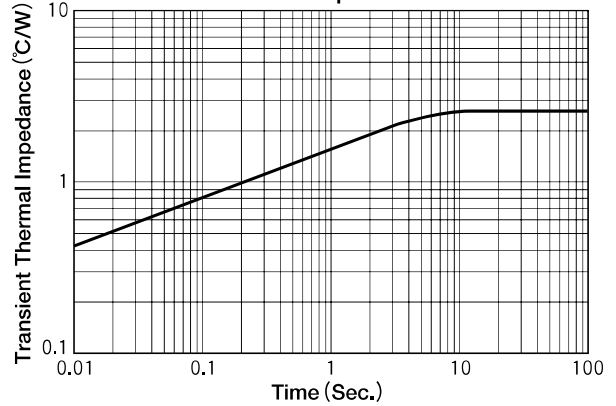

### I<sub>GT</sub> - T<sub>j</sub> (Typical)

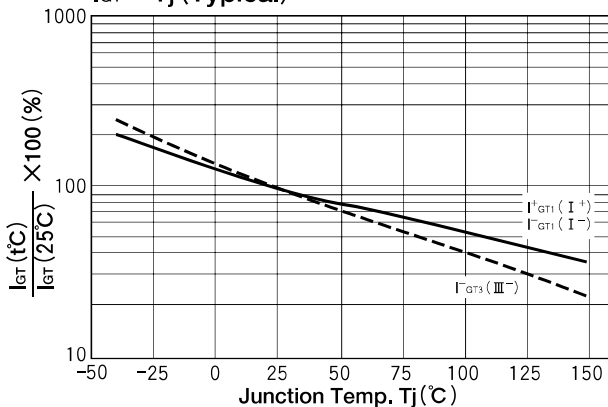

### V<sub>GT</sub> - T<sub>j</sub> (Typical)

