

TRIAC (ISOLATED TYPE)

TG25C/E/D

UL:E76102(M)

TG25C/E/D are isolated molded triacs suitable for wide range of applications like copier, microwave oven, solid state switch, motor control, light control and heater control.

- I_{T(AV)} 25A
- High surge capability 250A
- Isolated Nounting (AC2500V)
- Tab Terminals

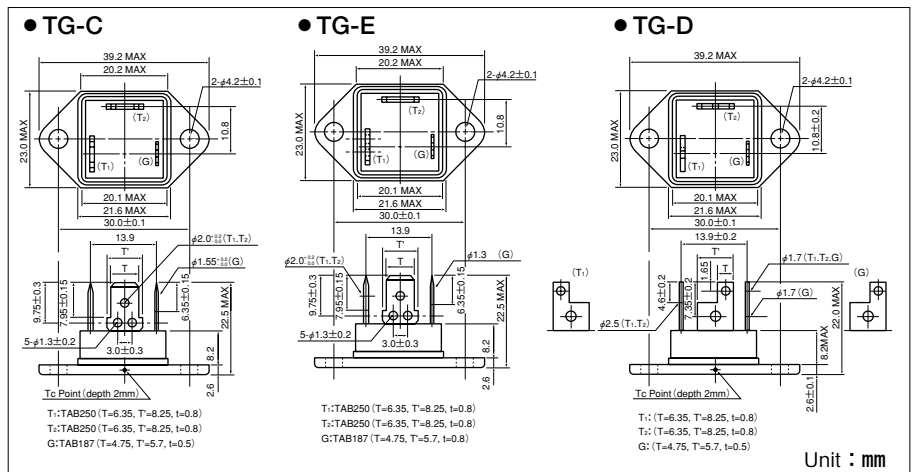
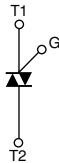

Maximum Ratings

(T_j=25°C unless otherwise specified)

Symbol	Item	Ratings		Unit
		TG25C40	TG25C60	
V _{DRM}	Repetitive Peak Off-State Voltage	400	600	V

Symbol	Item	Conditions	Ratings	Unit
I _{T(RMS)}	R.M.S. On-State Current	T _c =74°C	25	A
I _{TSM}	Surge On-State Current	One cycle, 50Hz/60Hz, peak, non-repetitive	220/250	A
I ² t	I ² t	Value for one cycle of surge current	260	A ² S
P _{GM}	Peak Gate Power Dissipation		10	W
P _{G(AV)}	Average Gate Power Dissipation		1	W
I _{GM}	Peak Gate Current		3	A
V _{GM}	Peak Gate Voltage		10	V
di/dt	Critical Rate of Rise of On-State Current	I _G =100mA, T _j =25°C, V _D =1/2V _{DRM} , di _G /dt=1A/μs	50	A/μs
T _j	Operating Junction Temperature		-25 to +125	°C
T _{stg}	Storage Temperature		-40 to +125	°C
V _{iso}	Isolation Breakdown Voltage (R.M.S.)	A.C. 1 minute	2500	V
	Mounting Torque (M4)	Recommended Value 1.0-1.4 (10-14)	1.5 (15)	N·m (kgf·cm)
	Mass	Typical value (Excluding bolt, nut and wrapping material)	27	g

Electrical Characteristics

Symbol	Item	Conditions	Ratings	Unit
I _{DRM}	Repetitive Peak Off-State Current, max	V _D =V _{DRM} , Single phase, half wave, T _j =125°C	5	mA
V _{TM}	Peak On-State Voltage, max	On-State Current (√2×I _{T(RMS)}), Inst. measurement	1.4	V
I _{GT1} ⁺	Gate Trigger Current, max	T _j =25°C, I _T =1A, V _D =6V	50	mA
I _{GT1} ⁻		T _j =25°C, I _T =1A, V _D =6V	50	
I _{GT3} ⁺		—	—	
I _{GT3} ⁻		T _j =25°C, I _T =1A, V _D =6V	50	
V _{GT1} ⁺	Gate Trigger Voltage, max	T _j =25°C, I _T =1A, V _D =6V	3	V
V _{GT1} ⁻		T _j =25°C, I _T =1A, V _D =6V	3	
V _{GT3} ⁺		—	—	
V _{GT3} ⁻		T _j =25°C, I _T =1A, V _D =6V	3	
V _{GD}	Non-Trigger Gate Voltage, min	T _j =125°C, V _D =1/2V _{DRM}	0.2	V
t _{gt}	Turn On Time, max.	I _{T(RMS)} , I _G =100mA, V _D =1/2V _{DRM} , T _j =25°C, di _G /dt=1A/μs	10	V
dv/dt	Critical Rate of Rise on-State Voltage, min.	T _j =125°C, V _D =2/3V _{DRM} , Exponential wave.	50	V/μs
(dv/dt) _c	Critical Rate of Rise off-State Voltage at commutation, min	T _j =125°C, V _D =2/3V _{DRM} , (di/dt) _c =15A/ms	6	V/μs
I _H	Holding Current, typ.	T _j =25°C	30	mA
R _{th(j-c)}	Thermal Impedance, max	Junction to case	1.6	°C/W

