

THYRISTOR MODULE

PK(PD,PE,KK)90F

UL:E76102(M)

Power Thyristor/Diode Module **PK90F** series are designed for various rectifier circuits and power controls. For your circuit application, following internal connections and wide voltage ratings up to 1,600V are available. High precision 25mm (1inch) width package and electrically isolated mounting base make your mechanical design easy.

- $I_{T(AV)}$ 90A, $I_{T(RMS)}$ 140A, I_{TSM} 2300A
- di/dt 200 A/ μ s
- dv/dt 500V/ μ s

(Applications)

Various rectifiers
AC/DC motor drives
Heater controls
Light dimmers
Static switches

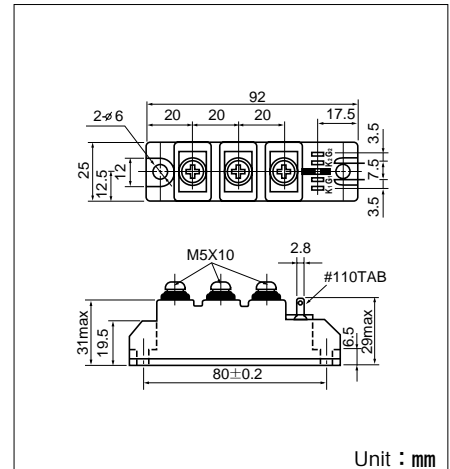
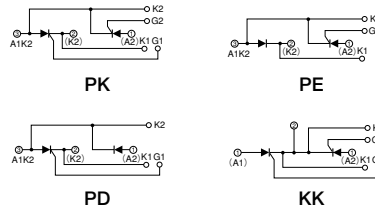

Unit : mm

Maximum Ratings

Symbol	Item	Ratings				Unit
		PK90F40 PD90F40 PE90F40 KK90F40	PK90F80 PD90F80 PE90F80 KK90F80	PK90F120 PD90F120 PE90F120 KK90F120	PK90F160 PD90F160 PE90F160 KK90F160	
VRRM	* Repetitive Peak Reverse Voltage	400	800	1200	1600	V
VRSM	* Non-Repetitive Peak Reverse Voltage	480	960	1300	1700	V
VDRM	Repetitive Peak Off-State Voltage	400	800	1200	1600	V

Symbol	Item	Conditions	Ratings	Unit	
$I_{T(AV)}$	* Average On-State Current	Single phase, half wave, 180° conduction, $T_c : 93^\circ\text{C}$	90	A	
$I_{T(RMS)}$	* R.M.S. On-State Current	Single phase, half wave, 180° conduction, $T_c : 93^\circ\text{C}$	140	A	
I_{TSM}	* Surge On-State Current	1/2 cycle, 50Hz/60Hz, peak Value, non-repetitive	2100/2300	A	
I^2t	* I^2t	Value for one cycle of surge current	22000	A ² S	
P _{GM}	Peak Gate Power Dissipation		10	W	
P _{G(AV)}	Average Gate Power Dissipation		3	W	
I _{FGM}	Peak Gate Current		3	A	
V _{FGM}	Peak Gate Voltage (Forward)		10	V	
V _{RGM}	Peak Gate Voltage (Reverse)		5	V	
di/dt	Critical Rate of Rise of On-State Current	$I_G=100\text{mA}$, $T_j=25^\circ\text{C}$, $V_D=1/2V_{DRM}$, $dI_G/dt=0.1\text{A}/\mu\text{s}$	200	A/ μ s	
V _{ISO}	* Isolation Breakdown Voltage (R.M.S.)	A.C. 1minute	2500	V	
T _j	* Operating Junction Temperature		-40 to +125	°C	
T _{stg}	* Storage Temperature		-40 to +125	°C	
	Mounting Torque	Mounting (M5)	Recommended Value 1.5-2.5 (15-25)	2.7 (28)	N·m (kgf·cm)
		Terminal (M5)	Recommended Value 1.5-2.5 (15-25)	2.7 (28)	
	Mass			170	g

Electrical Characteristics

Symbol	Item	Conditions	Ratings	Unit
I _{DRM}	Repetitive Peak Off-State Current, max.	at V _{DRM} , single phase, half wave, $T_j=125^\circ\text{C}$	20	mA
I _{RRM}	* Repetitive Peak Reverse Current, max.	at V _{DRM} , single phase, half wave, $T_j=125^\circ\text{C}$	20	mA
V _{TM}	* Peak On-State Voltage, max.	On-State Current 285A, $T_j=25^\circ\text{C}$ Inst. measurement	1.40	V
I _{GT} /V _{GT}	Gate Trigger Current/Voltage, max.	$T_j=25^\circ\text{C}$, $I_T=1\text{A}$, $V_D=6\text{V}$	100/3	mA/V
V _{GD}	Non-Trigger Gate, Voltage. min.	$T_j=125^\circ\text{C}$, $V_D=1/2V_{DRM}$	0.25	V
t _{gt}	Turn On Time, max.	$I_T=90\text{A}$, $I_G=100\text{mA}$, $T_j=25^\circ\text{C}$, $V_D=1/2V_{DRM}$, $dI_G/dt=0.1\text{A}/\mu\text{s}$	10	μ s
dv/dt	Critical Rate of Rise of Off-State Voltage, min.	$T_j=125^\circ\text{C}$, $V_D=2/3V_{DRM}$, Exponential wave.	500	V/ μ s
I _H	Holding Current, typ.	$T_j=25^\circ\text{C}$	50	mA
I _L	Latching Current, typ.	$T_j=25^\circ\text{C}$	100	mA
R _{th(j-c)}	* Thermal Impedance, max.	Junction to case	0.27	°C/W

* mark : Thyristor and Diode part. No mark : Thyristor part

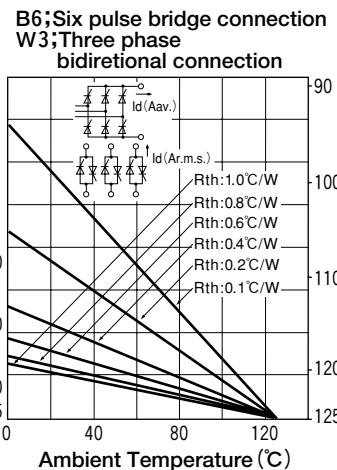
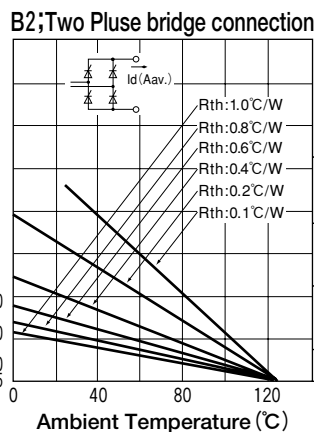
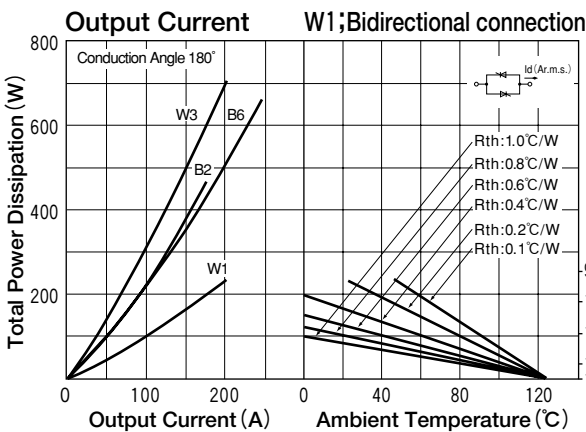
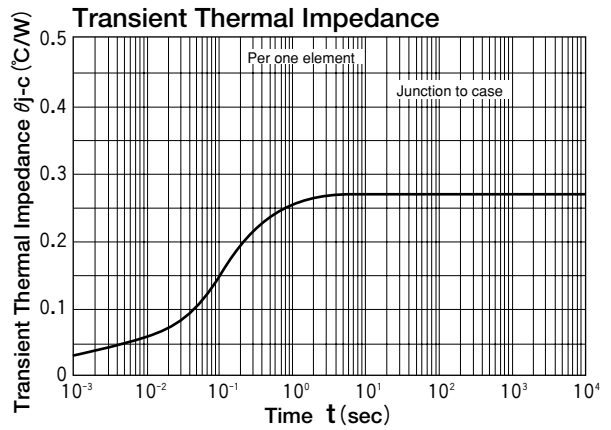
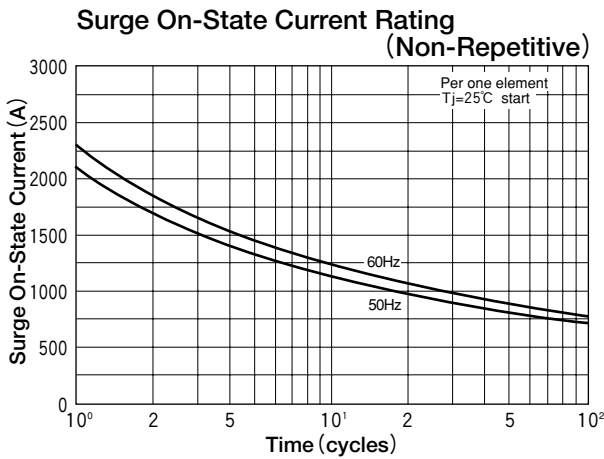
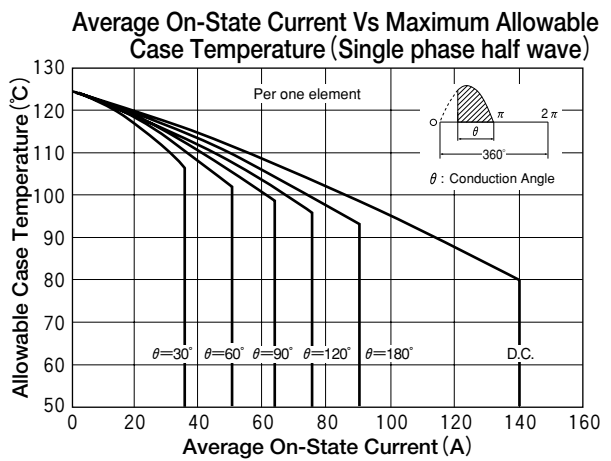
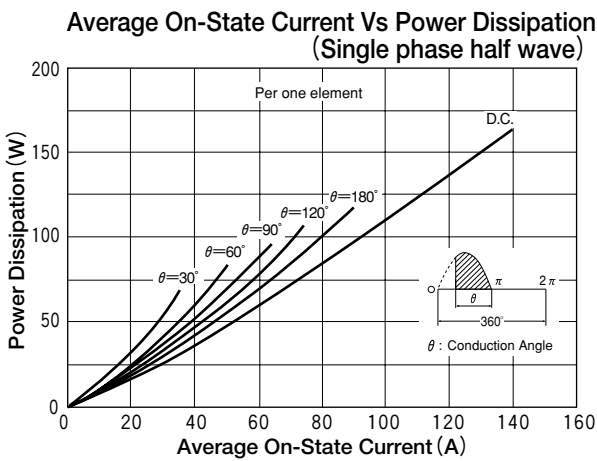
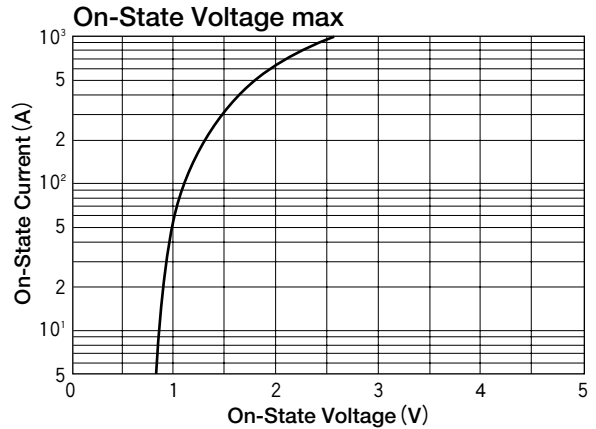
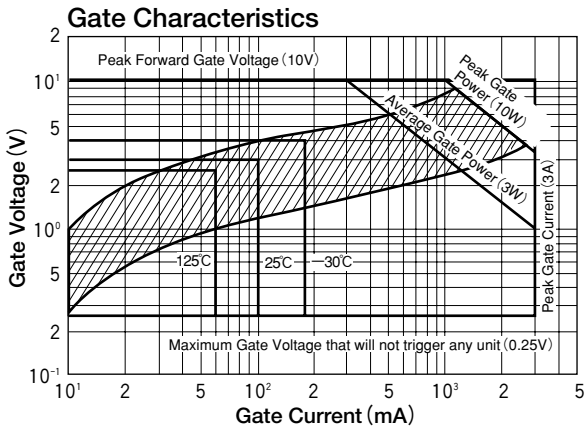

Allowable Case Temperature (°C)