

THYRISTOR MODULE

SCA (SCE) 90AA

UL: E76102 (M)

SCA (SCE) 90AA

《Advantages》

- Isolated package
- $I_T(AV)$ 90A
- di/dt 140A/ μ s
- dv/dt 1000V/ μ s

《Applications》

- various rectifiers, Motor drives, Heater controls, Static switches

《特長》

- 絶縁型パッケージ
- 平均電流 90A
- 定格臨海オン電流上昇率 140A/ μ s
- 定格臨海オフ電圧上昇率 1000V/ μ s

《用途》

- 各種整流器、モーター制御、ヒーター制御、静止型スイッチ

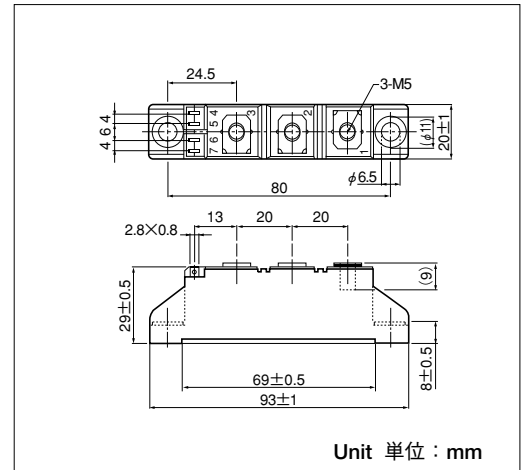
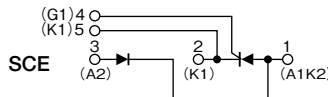
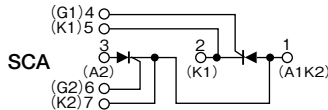

Unit 単位 : mm

■Maximum Ratings 最大定格

(Unless otherwise specified $T_j=25^\circ\text{C}$ / 指定なき場合は $T_j=25^\circ\text{C}$ とする)

Symbol 記号	Item 項目	Ratings 定格値		Unit 単位
		SCA90AA160 SCE90AA160		
V_{RRM}	*Repetitive Peak Reverse Voltage * 定格ピーク繰返し逆電圧	1600		V
V_{RSM}	*Non-Repetitive Peak Reverse Voltage * 定格ピーク非繰返し逆電圧	1700		V
V_{DRM}	Repetitive Peak Off-state Voltage 定格ピーク繰返しオフ電圧	1600		V

Symbol 記号	Item 項目	Conditions 条件	Ratings 定格値	Unit 単位
$I_T(AV)$ $I_F(AV)$	*Average On-state Current * 定格平均オン (順) 電流	Single phase, half wave, 180° conduction, $T_c=100^\circ\text{C}$ 単相半波平均値 180° 導通角 ケース温度	90	A
$I_T(RMS)$ $I_F(RMS)$	*R.M.S. On-state Current * 定格実効オン (順) 電流	Single phase, half wave, 180° conduction, $T_c=100^\circ\text{C}$ 単相半波実効値 180° 導通角 ケース温度	140	A
I_{TSM} I_{FSM}	*Surge On-state Current * 定格サージオン (順) 電流	$\frac{1}{2}$ cycle, 50/60Hz, Peak value, non-repetitive 50/60Hz $\frac{1}{2}$ サイクル正弦波 波高値 非繰返し	2100/2300	A
I^2t	* I^2t (for fusing) * 電流二乗時間積	Value for one cycle surge current 1 サイクルサージオン電流に対する値	22040	A^2s
P_{GM}	Peak Gate Power Dissipation 定格ピークゲート損失		10	W
$P_{G(AV)}$	Average Gate Power Dissipation 定格平均ゲート損失		1	W
I_{FGM}	Peak Gate Current 定格ピークゲート順電流		3	A
V_{FGM}	Peak Gate Voltage (Forward) 定格ピークゲート順電圧		10	V
V_{RGM}	Peak Gate Voltage (Reverse) 定格ピークゲート逆電圧		5	V
di/dt	Critical Rate of Rise of On-state Current 定格臨界オン電流上昇率	$I_G=100\text{mA}$, $V_D=\frac{1}{2}V_{DRM}$, $dI_G/dt=0.1\text{A}/\mu\text{s}$	140	$\text{A}/\mu\text{s}$
V_{ISO}	*Isolation Breakdown Voltage (R. M. S.) * 絶縁耐圧	A.C. 1minute 実効値, A.C. 1 分間	2500	V
T_j	*Operating Junction Temperature * 定格接合部温度		$-40 \sim +130$	$^\circ\text{C}$
T_{stg}	*Storage Temperature * 保存温度		$-40 \sim +125$	$^\circ\text{C}$
Mounting Torque 締付トルク	Mounting (M5) 取付	Recommended value 推奨値 1.5~2.5 (15~25)	2.7 (28)	N·m (kgf·cm)
	Terminal (M5) 端子	Recommended value 推奨値 1.5~2.5 (15~25)	2.7 (28)	
Mass 質量		Typical value 標準値	90	g

■Electrical Characteristics 電気的特性

(Unless otherwise specified Tj=25°C / 指定なき場合はTj=25°Cとする)

Symbol 記号	Item 項目	Conditions 条件	Ratings 定格値			Unit 単位
			Min.	Typ.	Max.	
I _{DRM}	Repetitive Peak Off-state Current, max 最大オフ電流	at V _{DRM} , Single phase, half wave 定格ピーク繰り返しオフ電圧に於て, 単相半波, Tj=130°C			20	mA
I _{RRM}	*Repetitive Peak Reverse Current, max *最大逆電流	at V _{RRM} , Single phase, half wave 定格ピーク繰り返し逆電圧に於て, 単相半波, Tj=130°C			20	mA
V _{TM} V _{FM}	*Peak On-state (Forward) Voltage, max *最大オン(順)電圧	On-State Current 270A, Inst, measurement オン(順)電流波高値 270A 瞬時測定			1.7	V
V _{T(TO)}	*Threshold Voltage, max *最大閾値電圧	Tj=25°C			1.09	V
		Tj=130°C			0.91	
r _t	*Dynamic Resistance, max *最大オン抵抗	Tj=25°C			2.3	mΩ
		Tj=130°C			3.2	
I _{GT}	Gate Trigger Current, max 最大ゲートトリガ電流	I _T =1A, V _D =6V			100	mA
V _{GT}	Gate Trigger Voltage, max 最大ゲートトリガ電圧	I _T =1A, V _D =6V			2.5	V
V _{GD}	Non-Trigger Gate Voltage, min 最小ゲート非トリガ電圧	Tj=130°C, V _D =½V _{DRM}	0.25			V
t _{gt}	Turn-on Time 最大ターンオン時間	I _T =90A, I _G =100mA, V _D =½V _{DRM} , di/dt=0.1A/μs			10	μs
dv/dt	Critical Rate of Rise of Off-state Voltage, min 最小臨界オフ電圧上昇率	Tj=130°C, V _D =¾V _{DRM} , Exponential wave 指数関数波形	1000			V/μs
I _H	Holding Current 代表保持電流			160		mA
I _L	Latching Current 代表ラッチング電流			280		mA
R _{th(j-c)}	*Thermal Impedance, max *最大熱抵抗	Junction to case (per Chip) 接合部-ケース間 (per Chip)			0.2	°C/W
R _{th(c-s)}		case to fin (per Chip) ケース-フィン間 (per Chip)		0.22		°C/W

*mark: Thyristor and Diode part, No mark: Thyristor part.

注) 上表中*印の項目は、サイリスタ部及びダイオード部の両方に適用します。その他の項目は主にサイリスタ部に適用します。

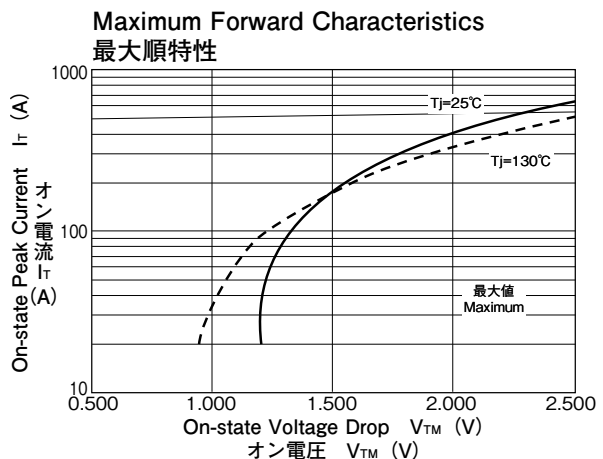
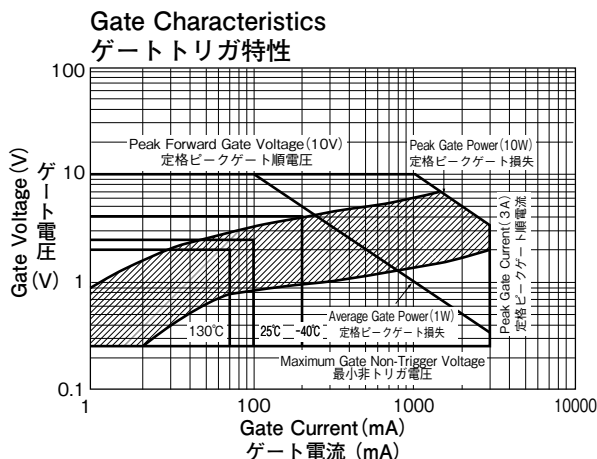

Surge Forward Current Rating (Non-Repetitive)

サージ順電流耐量 (非繰返し)

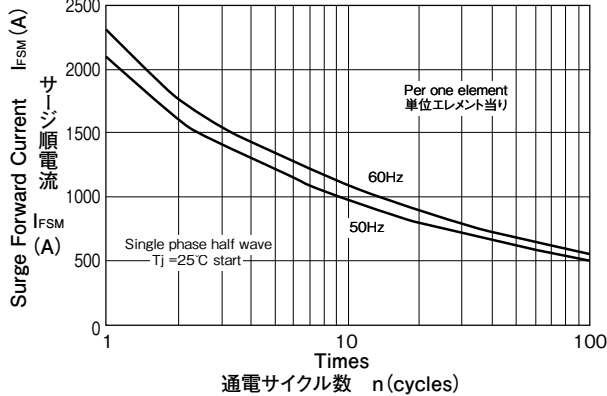

Transient Thermal Impedance

過渡熱インピーダンス特性

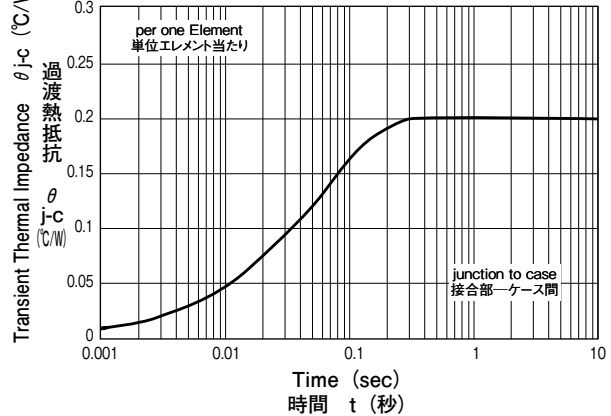

Average On-State Current vs Power Dissipation (Single Phase Half Wave)

最大電力損失特性 (単相半波)

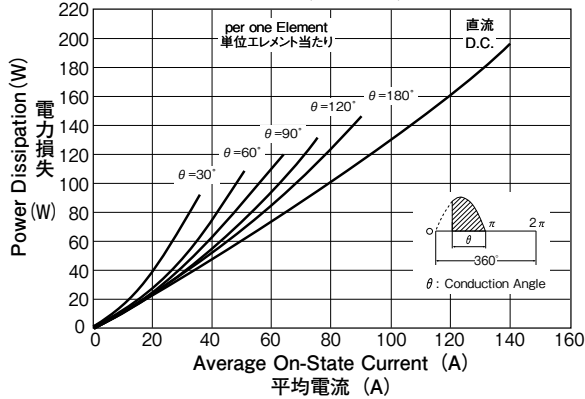

Current vs Allowable Case Temperature (Single Phase Half Wave)

電流対最大許容ケース温度 (単相半波)

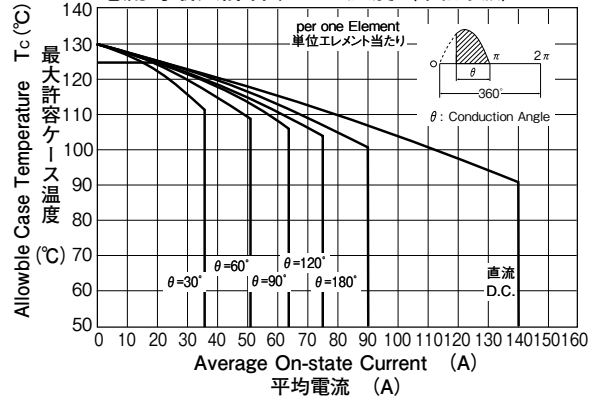

Output Current (W1; Bidirectional connection)

許容出力電流 (W1; 逆並列接続)

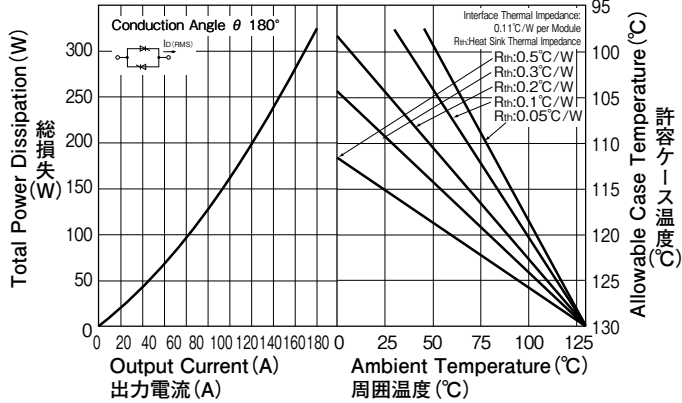

Output Current (B2; Two pulse bridge connection)

許容出力電流 (B2; 単相ブリッジ接続)

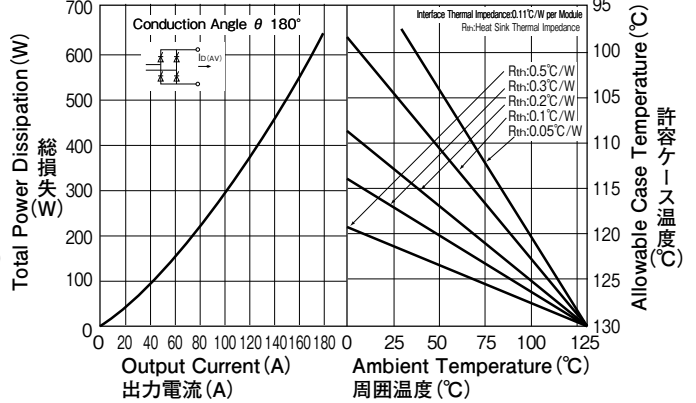

Output Current

(B6; Six pulse bridge connection, W3; Three phase bidirectional connection)

許容出力電流 (B6; 三相ブリッジ接続, W3; 三相逆並列接続)

