

# Si4410DYPbF

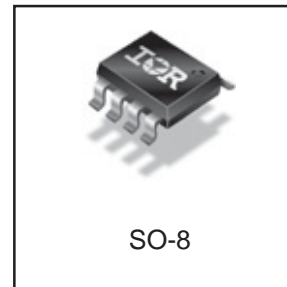
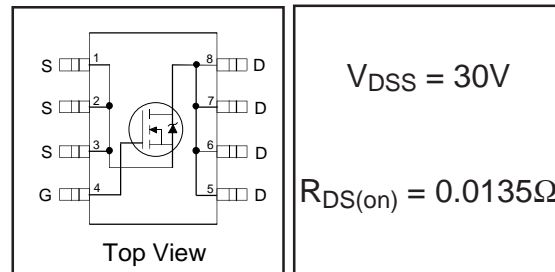
HEXFET® Power MOSFET

- N-Channel MOSFET
- Low On-Resistance
- Low Gate Charge
- Surface Mount
- Logic Level Drive
- Lead-Free

## Description

This N-channel HEXFET® Power MOSFET is produced using International Rectifier's advanced HEXFET power MOSFET technology. The low on-resistance and low gate charge inherent to this technology make this device ideal for low voltage or battery driven power conversion applications

The SO-8 package with copper leadframe offers enhanced thermal characteristics that allow power dissipation of greater than 800mW in typical board mount applications.



## Absolute Maximum Ratings

	Parameter	Max.	Units
$V_{DS}$	Drain- Source Voltage	30	V
$I_D @ T_A = 25^\circ C$	Continuous Drain Current, $V_{GS} @ 10V$	$\pm 10$	A
$I_D @ T_A = 70^\circ C$	Continuous Drain Current, $V_{GS} @ 10V$	$\pm 8.0$	
$I_{DM}$	Pulsed Drain Current ①	$\pm 50$	
$P_D @ T_A = 25^\circ C$	Power Dissipation ③	2.5	W
$P_D @ T_A = 70^\circ C$	Power Dissipation ③	1.6	
	Linear Derating Factor	0.02	W/°C
dv/dt	Peak Diode Recovery dv/dt ②	5.0	V/ns
$E_{AS}$	Single Pulse Avalanche Energy④	400	mJ
$V_{GS}$	Gate-to-Source Voltage	$\pm 20$	V
$T_J, T_{STG}$	Junction and Storage Temperature Range	-55 to + 150	°C

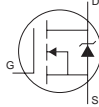
## Thermal Resistance

	Parameter	Max.	Units
$R_{\theta JA}$	Maximum Junction-to-Ambient③	50	°C/W

Electrical Characteristics @  $T_J = 25^\circ\text{C}$  (unless otherwise specified)

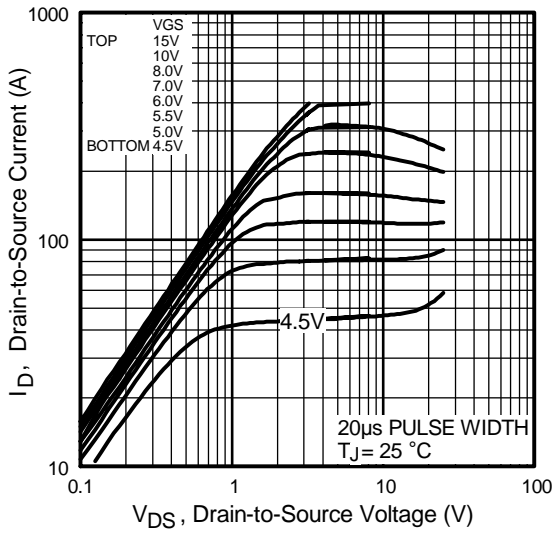
	Parameter	Min.	Typ.	Max.	Units	Conditions
$V_{(BR)DSS}$	Drain-to-Source Breakdown Voltage	30	—	—	V	$V_{GS} = 0V, I_D = 250\mu A$
$\Delta V_{(BR)DSS}/\Delta T_J$	Breakdown Voltage Temp. Coefficient	—	0.029	—	V/°C	Reference to $25^\circ\text{C}$ , $I_D = 1\text{mA}$
$R_{DS(on)}$	Static Drain-to-Source On-Resistance	—	0.010	0.0135	$\Omega$	$V_{GS} = 10V, I_D = 10A$ ②
		—	0.015	0.020		$V_{GS} = 4.5V, I_D = 5.0A$ ②
$V_{GS(th)}$	Gate Threshold Voltage	1.0	—	—	V	$V_{DS} = V_{GS}, I_D = 250\mu A$
$g_{fs}$	Forward Transconductance	—	35	—	S	$V_{DS} = 15V, I_D = 10A$
$I_{DSS}$	Drain-to-Source Leakage Current	—	—	1.0	$\mu A$	$V_{DS} = 30V, V_{GS} = 0V$
		—	—	25		$V_{DS} = 30V, V_{GS} = 0V, T_J = 55^\circ\text{C}$
$I_{GSS}$	Gate-to-Source Forward Leakage	—	—	-100	nA	$V_{GS} = -20V$
	Gate-to-Source Reverse Leakage	—	—	100		$V_{GS} = 20V$
$Q_g$	Total Gate Charge	—	30	45	nC	$I_D = 10A$
$Q_{gs}$	Gate-to-Source Charge	—	5.4	—		$V_{DS} = 15V$
$Q_{gd}$	Gate-to-Drain ("Miller") Charge	—	6.5	—		$V_{GS} = 10V$ , See Fig. 10 ②
$t_{d(on)}$	Turn-On Delay Time	—	11	—	ns	$V_{DD} = 25V$
$t_r$	Rise Time	—	7.7	—		$I_D = 1.0A$
$t_{d(off)}$	Turn-Off Delay Time	—	38	—		$R_G = 6.0\Omega$
$t_f$	Fall Time	—	44	—		$R_D = 25\Omega$ , ②
$C_{iss}$	Input Capacitance	—	1585	—	pF	$V_{GS} = 0V$
$C_{oss}$	Output Capacitance	—	739	—		$V_{DS} = 15V$
$C_{rss}$	Reverse Transfer Capacitance	—	106	—		$f = 1.0\text{MHz}$ , See Fig. 9

## Source-Drain Ratings and Characteristics

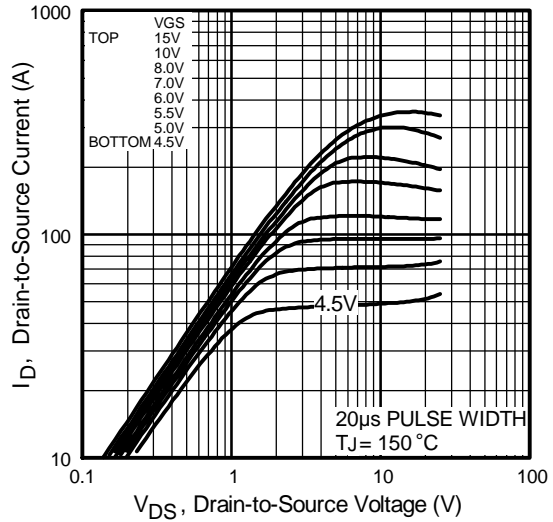
	Parameter	Min.	Typ.	Max.	Units	Conditions
$I_S$	Continuous Source Current (Diode Conduction) ③	—	—	2.3	A	MOSFET symbol showing the integral reverse p-n junction diode. 
$I_{SM}$	Pulsed Source Current (Body Diode) ①	—	—	50		
$V_{SD}$	Diode Forward Voltage	—	0.7	1.1	V	$T_J = 25^\circ\text{C}$ , $I_S = 2.3A$ , $V_{GS} = 0V$ ②
$t_{rr}$	Reverse Recovery Time	—	50	80	ns	$T_J = 25^\circ\text{C}$ , $I_F = 2.3A$

## Notes:

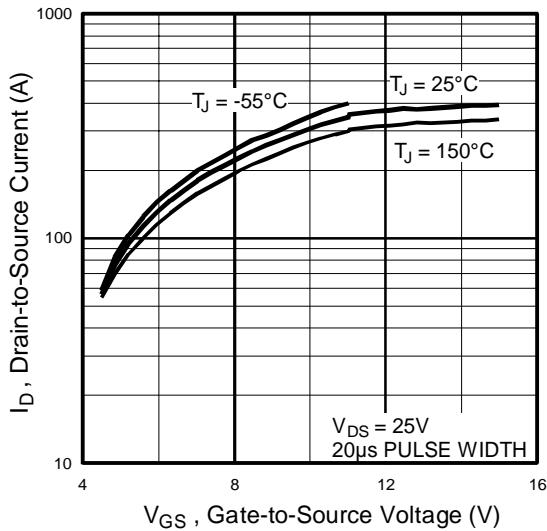
- ① Repetitive rating; pulse width limited by max. junction temperature.
- ② Pulse width  $\leq 300\mu s$ ; duty cycle  $\leq 2\%$ .
- ③ When mounted on FR4 Board,  $t \leq 10$  sec
- ④ Starting  $T_J = 25^\circ\text{C}$ ,  $L = 8.0\text{mH}$   
 $R_G = 25\Omega$ ,  $I_{AS} = 10A$ . (See Figure 15)
- ⑤  $I_{SD} \leq 2.3A$ ,  $di/dt \leq 130A/\mu s$ ,  $V_{DD} \leq V_{(BR)DSS}$ ,  
 $T_J \leq 150^\circ\text{C}$



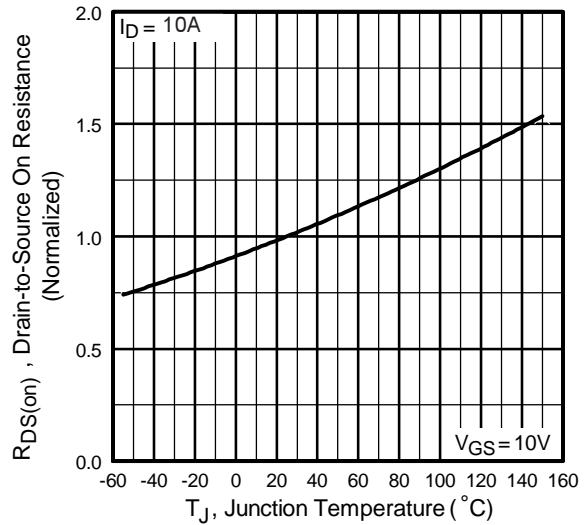
**Fig 1.** Typical Output Characteristics



**Fig 2.** Typical Output Characteristics



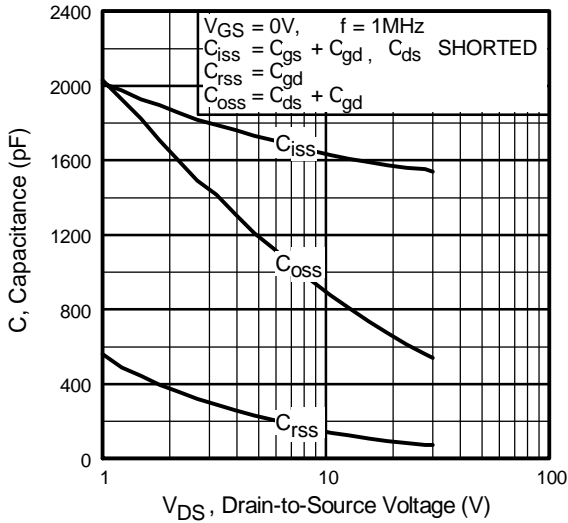
**Fig 3.** Typical Transfer Characteristics



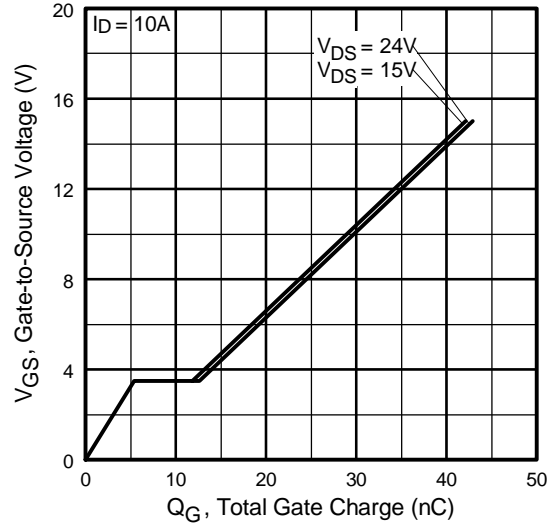
**Fig 4.** Normalized On-Resistance Vs. Temperature

# Si4410DYPbF

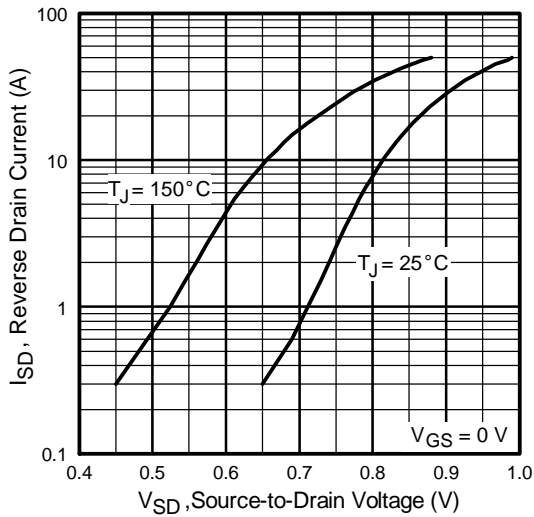
International  
**IRF** Rectifier



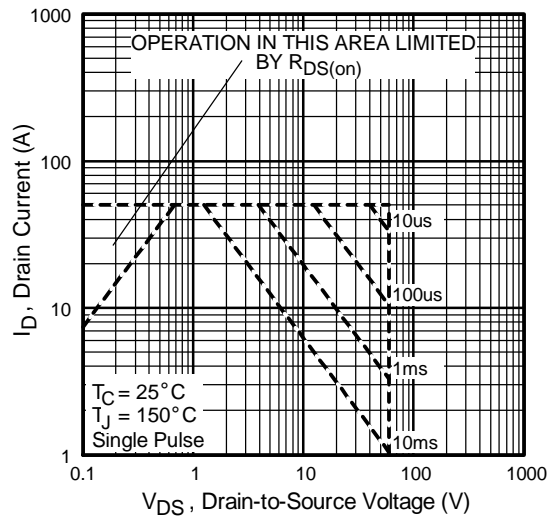
**Fig 5.** Typical Capacitance Vs. Drain-to-Source Voltage



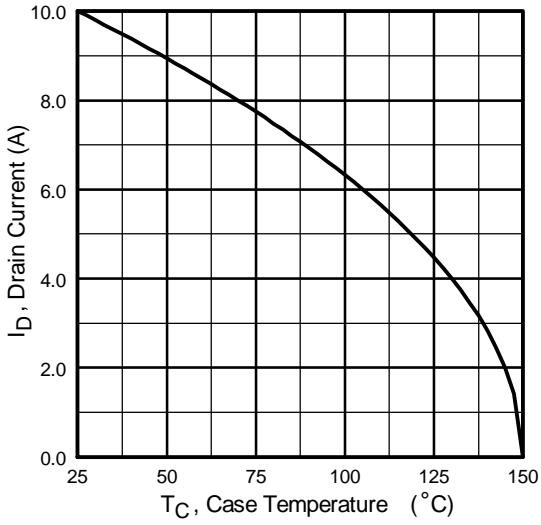
**Fig 6.** Typical Gate Charge Vs. Gate-to-Source Voltage



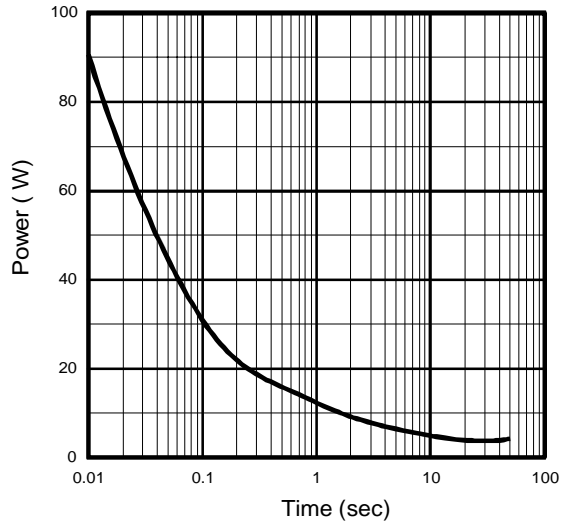
**Fig 7.** Typical Source-Drain Diode Forward Voltage



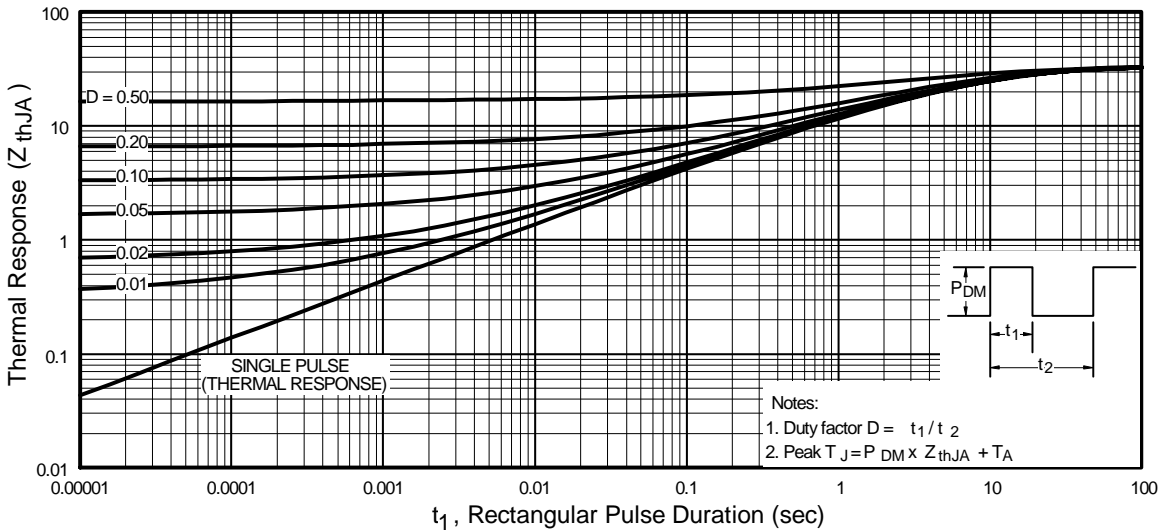
**Fig 8.** Maximum Safe Operating Area



**Fig 9.** Maximum Drain Current Vs. Case Temperature

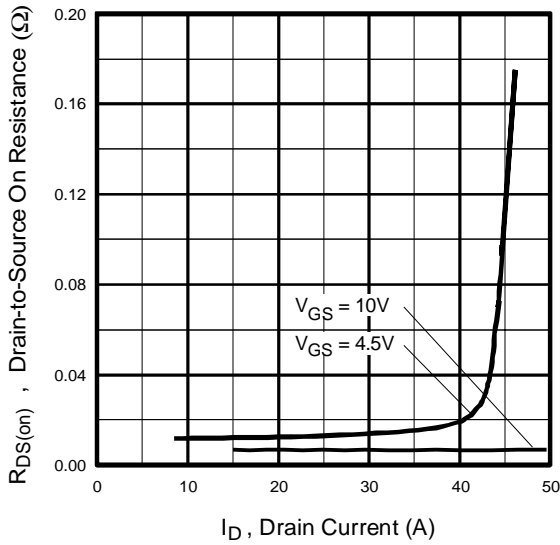


**Fig 10.** Typical Power Vs. Time

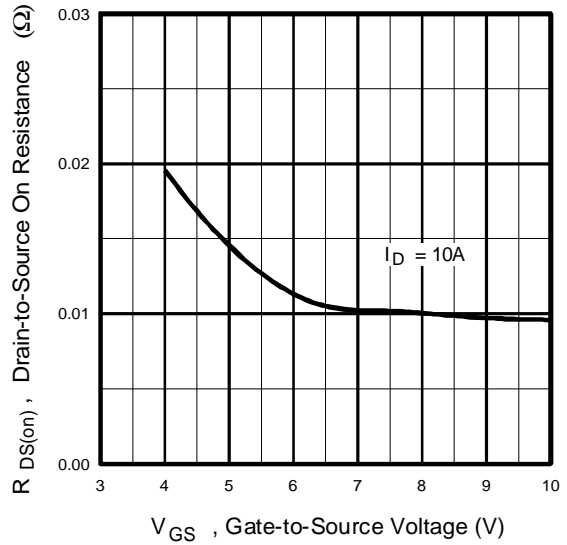


**Fig 11.** Typical Effective Transient Thermal Impedance, Junction-to-Ambient

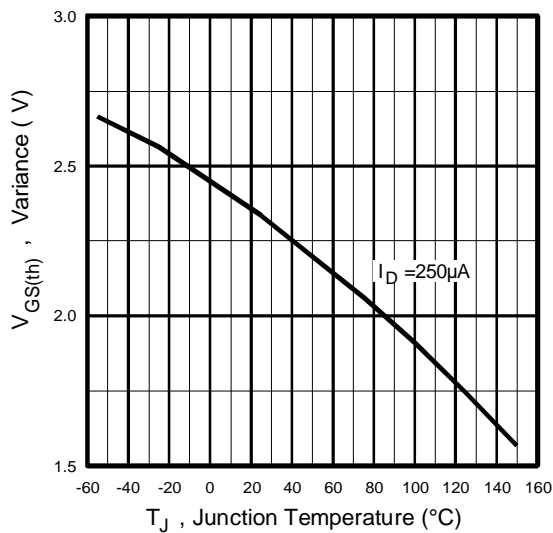
# Si4410DYPbF



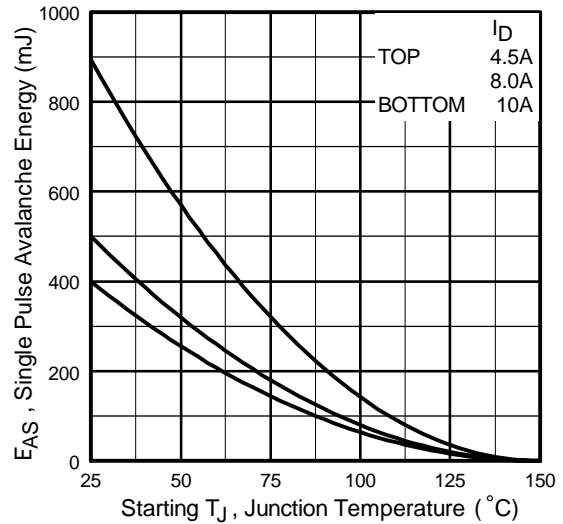
**Fig 12.** Typical On-Resistance Vs. Drain Current



**Fig 13.** Typical On-Resistance Vs. Gate Voltage



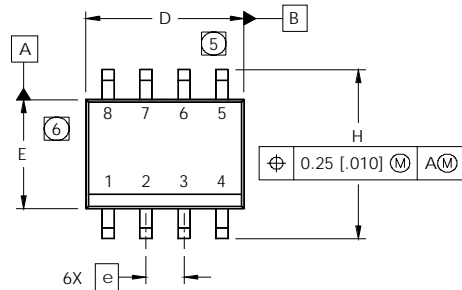
**Fig 14.** Typical Threshold Voltage Vs. Temperature



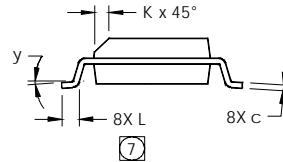
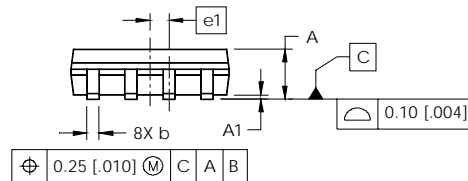
**Fig 15.** Maximum Avalanche Energy Vs. Drain Current

## SO-8 Package Outline

Dimensions are shown in millimeters (inches)



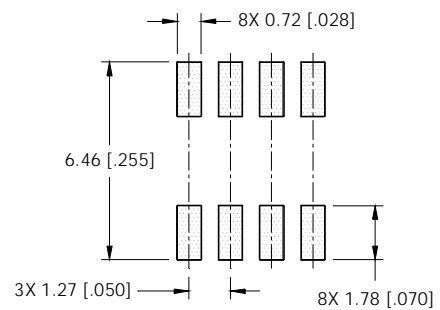
DIM	INCHES		MILLIMETERS	
	MIN	MAX	MIN	MAX
A	.0532	.0688	1.35	1.75
A1	.0040	.0098	0.10	0.25
b	.013	.020	0.33	0.51
c	.0075	.0098	0.19	0.25
D	.189	.1968	4.80	5.00
E	.1497	.1574	3.80	4.00
e	.050 BASIC		1.27 BASIC	
e1	.025 BASIC		0.635 BASIC	
H	.2284	.2440	5.80	6.20
K	.0099	.0196	0.25	0.50
L	.016	.050	0.40	1.27
y	0°	8°	0°	8°



**NOTES:**

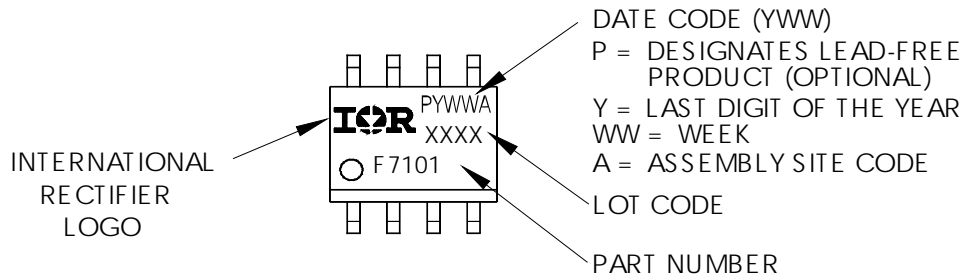
1. DIMENSIONING & TOLERANCING PER ASME Y14.5M-1994.
2. CONTROLLING DIMENSION: MILLIMETER
3. DIMENSIONS ARE SHOWN IN MILLIMETERS [INCHES].
4. OUTLINE CONFORMS TO JEDEC OUTLINE MS-012AA.
- ⑤ DIMENSION DOES NOT INCLUDE MOLD PROTRUSIONS. MOLD PROTRUSIONS NOT TO EXCEED 0.15 [0.006].
- ⑥ DIMENSION DOES NOT INCLUDE MOLD PROTRUSIONS. MOLD PROTRUSIONS NOT TO EXCEED 0.25 [0.010].
- ⑦ DIMENSION IS THE LENGTH OF LEAD FOR SOLDERING TO A SUBSTRATE.

**FOOTPRINT**



## SO-8 Part Marking

EXAMPLE: THIS IS AN IRF7101 (MOSFET)

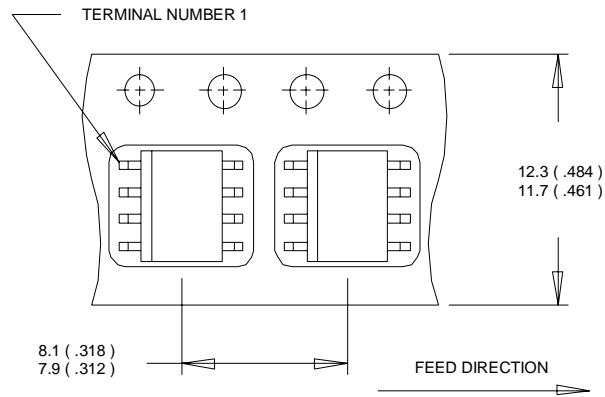


# Si4410DYPbF

International  
**IR** Rectifier

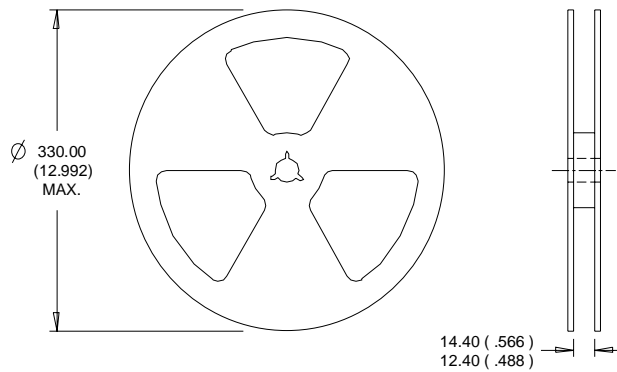
## SO-8 Tape and Reel

Dimensions are shown in millimeters (inches)



### NOTES:

1. CONTROLLING DIMENSION : MILLIMETER.
2. ALL DIMENSIONS ARE SHOWN IN MILLIMETERS(INCHES).
3. OUTLINE CONFORMS TO EIA-481 & EIA-541.



### NOTES:

1. CONTROLLING DIMENSION : MILLIMETER.
2. OUTLINE CONFORMS TO EIA-481 & EIA-541.

Data and specifications subject to change without notice.  
This product has been designed and qualified for the Consumer market.  
Qualifications Standards can be found on IR's Web site.

International  
**IR** Rectifier

**IR WORLD HEADQUARTERS:** 233 Kansas St., El Segundo, California 90245, USA Tel: (310) 252-7105  
TAC Fax: (310) 252-7903

Visit us at [www.irf.com](http://www.irf.com) for sales contact information.09/04

[www.irf.com](http://www.irf.com)