

# TPDxE05U06 1, 4, 6 Channel ESD Protection Device for Super-Speed (Up to 6 Gbps) Interface

## 1 Features

- IEC 61000-4-2 level 4 ESD protection
  - ±12-kV contact discharge
  - ±15-kV air gap discharge
- IEC 61000-4-4 EFT protection
  - 80 A (5/50 ns)
- IEC 61000-4-5 surge protection
  - 2.5 A (8/20 μs)
- IO capacitance 0.42 pF to 0.5 pF (typical)
- DC breakdown voltage 6.5 V (minimum)
- Ultra low leakage current 10 nA (maximum)
- Low ESD clamping voltage
- Industrial temperature range: –40°C to +125°C
- Easy straight-through routing packages
- Industry standard SOD-523 package (1.60 mm × 0.80 mm × 0.65 mm)

## 2 Applications

- [HDMI 1.4b](#)
- [HDMI 2.0](#)
- [USB 3.0](#)
- [MHL](#)
- [LVDS interfaces](#)
- [DisplayPort](#)
- [PCI-express®](#)
- [eSata interfaces](#)
- [V-by-One® HS](#)

## 3 Description

The TPDxE05U06 is a family of unidirectional Transient Voltage Suppressor (TVS) based Electrostatic Discharge (ESD) protection diodes with ultra-low capacitance. Each device can dissipate ESD strikes above the maximum level specified by the IEC 61000-4-2 international standard. The TPDxE05U06s ultra-low loading capacitance makes it ideal for protecting any high-speed signal pins.

Typical applications for TPDxE05U06 includes high speed signal lines in HDMI 1.4b, HDMI 2.0, USB 3.0, MHL, LVDS, DisplayPort, PCI-Express®, eSata, and V-by-One® HS.

### Device Information<sup>(1)</sup>

| PART NUMBER | PACKAGE     | BODY SIZE (NOM)   |
|-------------|-------------|-------------------|
| TPD1E05U06  | X1SON (2)   | 0.60 mm × 1.00 mm |
|             | SOD-523 (2) | 0.80 mm × 1.20 mm |
| TPD4E05U06  | USON (10)   | 2.50 mm × 1.00 mm |
| TPD6E05U06  | USON (14)   | 3.50 mm × 1.35 mm |

(1) For all available packages, see the orderable addendum at the end of the data sheet.

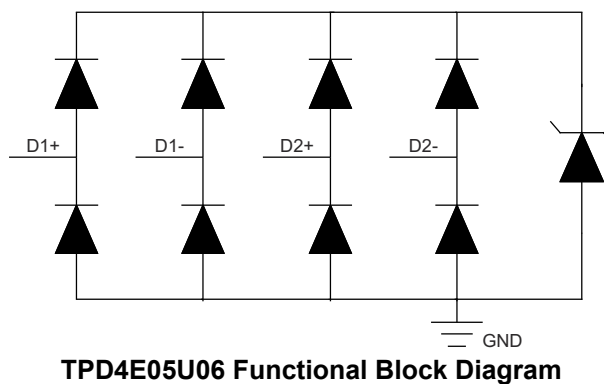
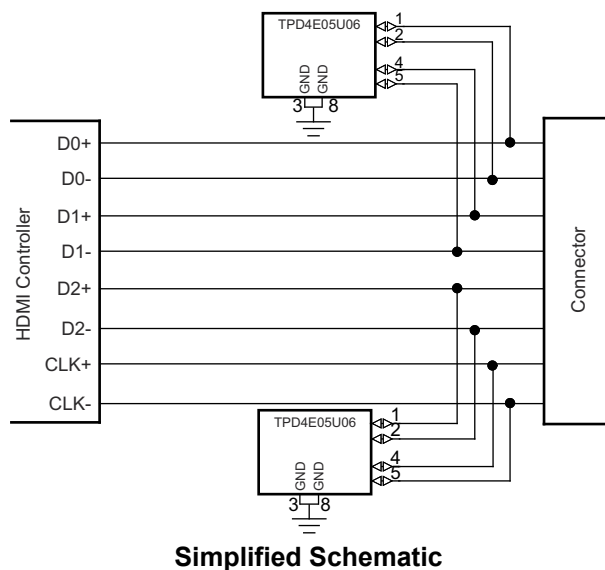

## Table of Contents

|  |    |  |    |
|--|----|--|----|
| <b>1 Features</b> .....                        | 1  | 7.4 Device Functional Modes.....                                     | 12 |
| <b>2 Applications</b> .....                    | 1  | <b>8 Application and Implementation</b> .....                        | 13 |
| <b>3 Description</b> .....                     | 1  | 8.1 Application Information.....                                     | 13 |
| <b>4 Revision History</b> .....                | 2  | 8.2 Typical Applications.....  | 13 |
| <b>5 Pin Configuration and Functions</b> ..... | 4  | <b>9 Power Supply Recommendations</b> .....                          | 16 |
| <b>6 Specifications</b> .....                  | 6  | <b>10 Layout</b> .....   | 17 |
| Absolute Maximum Ratings.....                  | 6  | 10.1 Layout Guidelines.....  | 17 |
| 6.1 ESD Ratings—JEDEC Specification.....       | 6  | 10.2 Layout Example.....   | 17 |
| 6.2 ESD Ratings—IEC Specification.....         | 6  | <b>11 Device and Documentation Support</b> .....                     | 19 |
| Recommended Operating Conditions.....          | 6  | 11.1 Documentation Support.....                                      | 19 |
| 6.3 Thermal Information.....                   | 7  | 11.2 Receiving Notification of Documentation Updates..               | 19 |
| 6.4 Electrical Characteristics.....            | 7  | 11.3 Support Resources.....  | 19 |
| 6.5 Typical Characteristics.....               | 9  | 11.4 Trademarks.....   | 19 |
| <b>7 Detailed Description</b> .....            | 11 | 11.5 Electrostatic Discharge Caution.....                            | 19 |
| 7.1 Overview.....                              | 11 | 11.6 Glossary.....   | 19 |
| 7.2 Functional Block Diagram.....              | 11 | <b>12 Mechanical, Packaging, and Orderable<br/>Information</b> ..... | 19 |
| 7.3 Feature Description.....                   | 12 |  |    |

## 4 Revision History

NOTE: Page numbers for previous revisions may differ from page numbers in the current version.

### Changes from Revision M (January 2017) to Revision N (February 2022) Page

- Updated the SOD-523 package information from the body size dimensions (0.8 mm × 1.2 mm) to the lead-to-lead dimensions (1.60 mm × 0.80 mm × 0.65 mm) ..... 1

### Changes from Revision L (January 2017) to Revision M (December 2021) Page

- Updated the numbering format for tables, figures, and cross-references throughout the document..... 1
- Updated the *Features* section to include SOD-523 package information..... 1
- Added the DYA package to the *Device Information* table..... 1
- Added the DYA package to the *Pin Configuration and Functions* section..... 4
- Changed the minimum *DC breakdown voltage* from 6 V to 6.5 V in the *Detailed Description* section..... 12
- Changed the minimum *reverse standoff voltage* from 5 V to 5.5 V in the *Detailed Description* section..... 12
- Updated the *Related Documentation* section..... 19

### Changes from Revision K (November 2016) to Revision L (January 2017) Page

- Updated DPY pinout image..... 4
- Updated title from TPD4E05U06 to TPD6E05U06 in [Figure 7-3](#) ..... 11

### Changes from Revision J (March 2016) to Revision K (November 2016) Page

- Changed min value of  $V_{BR}$  from 6 V to 6.5 V in the *Electrical Characteristics* table..... 6

### Changes from Revision I (June 2015) to Revision J (March 2016) Page

- Replaced all instances of X2SON with X1SON ..... 1
- Update the *Pin Functions* table ..... 4
- Added the *Power Supply Recommendations* section..... 16

### Changes from Revision H (May 2015) to Revision I (June 2015) Page

- Added trademarks ..... 1
- Corrected TPD6E05U06 Pin 13 name..... 4
- Corrected TLP definition..... 6

| <b>Changes from Revision G (July 2014) to Revision H (May 2015)</b>          | <b>Page</b> |
|--|-------------|
| • Added additional application.....  | 1           |
| • Updated with HDMI 2.0 Eye Diagrams.....                                    | 14          |
| <hr/>  |             |
| <b>Changes from Revision F (November 2013) to Revision G (July 2014)</b>     | <b>Page</b> |
| • Added 61000-4-4 EFT compliance.....  | 1           |
| • Added <i>Thermal Information</i> table.....                                | 6           |
| • Added <i>Handling Ratings</i> table.....                                   | 6           |
| • Added the <i>Detailed Description</i> section.....                         | 11          |
| • Added the <i>Application and Implementation</i> section.....               | 13          |
| • Added Layout section. ....   | 17          |
| <hr/>  |             |
| <b>Changes from Revision * (December 2012) to Revision A (December 2012)</b> | <b>Page</b> |
| • Added TPS2EUSB30A part to document.....                                    | 1           |
| <hr/>  |             |
| <b>Changes from Revision A (December 2012) to Revision B (January 2013)</b>  | <b>Page</b> |
| • Added Insertion Loss Graphic.....  | 9           |
| • Added Eye Diagrams.....  | 14          |
| <hr/>  |             |
| <b>Changes from Revision B (January 2013) to Revision C (March 2013)</b>     | <b>Page</b> |
| • Changed IO Capacitance range.....  | 1           |
| • Changed test conditions and typ values for $V_{clamp}$ .....               | 6           |
| • Added typ $R_{DYN}$ values for DQA and RVZ packages.....                   | 6           |
| • Added $C_L$ values for DQA and RVZ packages.....                           | 6           |
| • Changed CURRENT vs VOLTAGE graphic.....                                    | 9           |
| • Changed Insertion Loss graphic.....  | 9           |
| • Changed HDMI Eye Diagrams.....   | 14          |
| <hr/>  |             |
| <b>Changes from Revision C (March 2013) to Revision D ( )</b>                | <b>Page</b> |
| • Updated Title.....   | 1           |
| • Removed Ordering Information table.....                                    | 4           |
| <hr/>  |             |
| <b>Changes from Revision D (August 2013) to Revision E (November 2013)</b>   | <b>Page</b> |
| • Updated document formatting.....   | 1           |
| • Added additional application.....  | 1           |

## 5 Pin Configuration and Functions

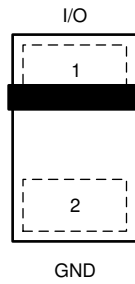

Figure 5-1. DPY Package 2-Pin X1SON Top View

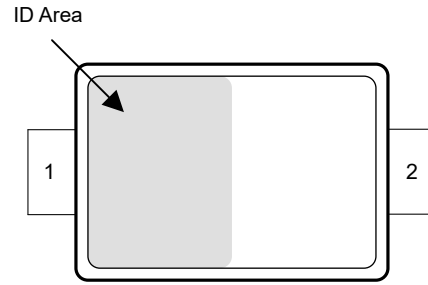

Figure 5-2. DYA Package 2-Pin SOD-523 Top View

Table 5-1. Pin Functions TPD1E05U06 DPY and DYA

| PIN  |     | TYPE   | DESCRIPTION                          |
|------|-----|--------|--------------------------------------|
| NAME | NO. |        |                                      |
| GND  | 2   | Ground | Ground; Connect to ground            |
| I/O  | 1   | I/O    | ESD protected channel <sup>(1)</sup> |

(1) Place as close to the connector as possible.

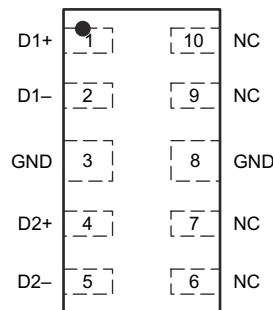
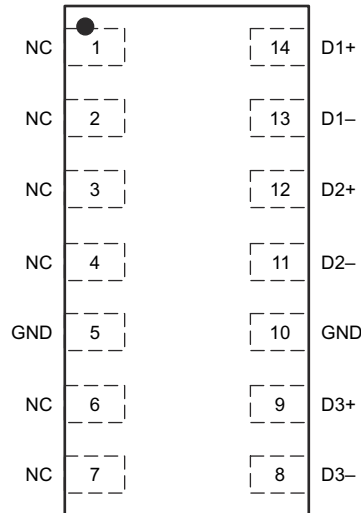

Figure 5-3. DQA Package 10-Pin USON Top View

Table 5-2. Pin Functions TPD4E05U06 DQA

| PIN  |     | TYPE   | DESCRIPTION   |
|------|-----|--------|---|
| NAME | NO. |        |   |
| D1+  | 1   | I/O    | ESD protected channel <sup>(1)</sup>  |
| D1–  | 2   | I/O    | ESD protected channel <sup>(1)</sup>  |
| D2+  | 4   | I/O    | ESD protected channel <sup>(1)</sup>  |
| D2–  | 5   | I/O    | ESD protected channel <sup>(1)</sup>  |
| GND  | 3   | Ground | Ground; Connect to ground   |
| GND  | 8   |        |   |
| NC   | 6   | —      | Not connected; Used for optional straight-through routing. Can be left floating or grounded |
| NC   | 7   |        |   |
| NC   | 9   |        |   |
| NC   | 10  |        |   |

(1) Place as close to the connector as possible.



**Figure 5-4. RVZ Package 14-Pin USON Top View**

**Table 5-3. Pin Functions TPD6E05U06 RVZ**

| PIN  |     | TYPE   | DESCRIPTION   |
|------|-----|--------|---|
| NAME | NO. |        |   |
| D1+  | 14  | I/O    | ESD protected channel <sup>(1)</sup>  |
| D1-  | 13  | I/O    | ESD protected channel <sup>(1)</sup>  |
| D2+  | 12  | I/O    | ESD protected channel <sup>(1)</sup>  |
| D2-  | 11  | I/O    | ESD protected channel <sup>(1)</sup>  |
| D3+  | 9   | I/O    | ESD protected channel <sup>(1)</sup>  |
| D3-  | 8   | I/O    | ESD protected channel <sup>(1)</sup>  |
| GND  | 5   | Ground | Ground; Connect to ground   |
| GND  | 10  |        |   |
| NC   | 1   | —      | Not connected; Used for optional straight-through routing. Can be left floating or grounded |
| NC   | 2   |        |   |
| NC   | 3   |        |   |
| NC   | 4   |        |   |
| NC   | 6   |        |   |
| NC   | 7   |        |   |

(1) Place as close to the connector as possible.

## 6 Specifications

### Absolute Maximum Ratings

over operating free-air temperature range (unless otherwise noted) <sup>(1)</sup>

|                                      |                                   | MIN | MAX | UNIT |
|--------------------------------------|-----------------------------------|-----|-----|------|
| Electrical Fast Transient<br>(2) (3) | IEC 61000-4-4 (5/50ns)            |     | 80  | A    |
| Peak Pulse (2) (3)                   | IEC 61000-4-5 Current<br>(8/20us) |     | 2.5 | A    |
|                                      | IEC 61000-4-5 Power<br>(8/20us)   |     | 40  | W    |
| T <sub>A</sub>                       | Ambient Operating<br>Temperature  | -40 | 125 | °C   |
| T <sub>stg</sub>                     | Storage Temperature               | -65 | 155 | °C   |

- (1) Stresses beyond those listed under Absolute Maximum Ratings may cause permanent damage to the device. These are stress ratings only, which do not imply functional operation of the device at these or any other conditions beyond those indicated under Recommended Operating Conditions. Exposure to absolute-maximum-rated conditions for extended periods may affect device reliability.
- (2) Voltages are with respect to GND unless otherwise noted.
- (3) Measured at 25°C

### 6.1 ESD Ratings—JEDEC Specification

|                    |   |   | VALUE | UNIT |
|--------------------|---|---|-------|------|
| V <sub>(ESD)</sub> | Electrostatic discharge – DPY, DQA, and RVZ | Human body model (HBM), per ANSI/ESDA/<br>JEDEC JS-001 <sup>(1)</sup>             | ±4000 | V    |
|                    |   | Charged device model (CDM), per JEDEC<br>specification JESD22-C101 <sup>(2)</sup> | ±1500 | V    |
| V <sub>(ESD)</sub> | Electrostatic discharge – DYA               | Human body model (HBM), per ANSI/ESDA/<br>JEDEC JS-001                            | ±2500 | V    |
|                    |   | Charged device model (CDM), per JEDEC<br>specification JS-002                     | ±1000 | V    |

- (1) JEDEC document JEP155 states that 500-V HBM allows safe manufacturing with a standard ESD control process. Manufacturing with less than 500-V HBM is possible with the necessary precautions. Pins listed as ±4000 V may actually have higher performance.
- (2) JEDEC document JEP157 states that 250-V CDM allows safe manufacturing with a standard ESD control process. Manufacturing with less than 250-V CDM is possible with the necessary precautions. Pins listed as ±1500 V may actually have higher performance.

### 6.2 ESD Ratings—IEC Specification

|                    |                         |                                 | VALUE  | UNIT |
|--------------------|-------------------------|---------------------------------|--------|------|
| V <sub>(ESD)</sub> | Electrostatic discharge | IEC 61000-4-2 contact discharge | ±12000 | V    |
|                    |                         | IEC 61000-4-2 air-gap discharge | ±15000 |      |

### Recommended Operating Conditions

over operating free-air temperature range (unless otherwise noted)

|                 |                                   | MIN | NOM | MAX | UNIT |
|-----------------|-----------------------------------|-----|-----|-----|------|
| V <sub>IO</sub> | Input pin voltage                 | 0   |     | 5.5 | V    |
| T <sub>A</sub>  | Operating free-air<br>temperature | -40 |     | 125 | °C   |

### 6.3 Thermal Information

| THERMAL METRIC <sup>(1)</sup> |  | TPD1E05U06  |              | TPD4E05U06 | TPD6E05U06 | UNIT |
|-------------------------------|--|-------------|--------------|------------|------------|------|
|                               |  | DPY (X1SON) | DYA (SOD523) | DQA (USON) | RVZ (USON) |      |
|                               |  | 2 PINS      | 2 PINS       | 10 PINS    | 14 PINS    |      |
| R <sub>θJA</sub>              | Junction-to-ambient thermal resistance       | 697.3       | 772.1        | 327        | 197.9      | °C/W |
| R <sub>θJC(top)</sub>         | Junction-to-case (top) thermal resistance    | 471         | 444.6        | 189.5      | 119.1      | °C/W |
| R <sub>θJB</sub>              | Junction-to-board thermal resistance         | 575.9       | 540.4        | 257.7      | 92.6       | °C/W |
| Ψ <sub>JT</sub>               | Junction-to-top characterization parameter   | 175.7       | 159.9        | 60.9       | 22         | °C/W |
| Ψ <sub>JB</sub>               | Junction-to-board characterization parameter | 575.1       | 533.9        | 257        | 91.6       | °C/W |

(1) For more information about traditional and new thermal metrics, see the [Semiconductor and IC Package Thermal Metrics](#) application report.

### 6.4 Electrical Characteristics

over operating free-air temperature range (unless otherwise noted)

| PARAMETER                        |                                 | TEST CONDITION   | MIN                       | TYP  | MAX  | UNIT |
|----------------------------------|---------------------------------|--|---------------------------|------|------|------|
| <b>INPUT - OUTPUT RESISTANCE</b> |                                 |  |                           |      |      |      |
| V <sub>RWM</sub>                 | Reverse stand-off voltage       | I <sub>IO</sub> < 10 μA  |                           |      | 5.5  | V    |
| V <sub>BR</sub>                  | Break-down voltage              | I <sub>IO</sub> = 1 mA   | 6.5                       |      | 8.5  | V    |
| V <sub>Clamp</sub>               | Clamp voltage                   | I <sub>PP</sub> = 1 A, TLP, from I/O to GND <sup>(1)</sup>                           |                           | 10   |      | V    |
|                                  |                                 | I <sub>PP</sub> = 5 A, TLP, from I/O to GND <sup>(1)</sup>                           |                           | 14   |      |      |
|                                  |                                 | I <sub>PP</sub> = 1 A, TLP, from GND to I/O <sup>(1)</sup>                           |                           | 3    |      |      |
|                                  |                                 | I <sub>PP</sub> = 5 A, TLP, from GND to I/O <sup>(1)</sup>                           |                           | 7    |      |      |
| I <sub>LEAK</sub>                | Leakage current                 | V <sub>IO</sub> = 2.5 V  |                           | 0.01 | 10   | nA   |
| R <sub>DYN</sub>                 | Dynamic resistance              | DPY package  | I/O to GND <sup>(2)</sup> |      | 0.8  | Ω    |
|                                  |                                 |  | GND to I/O <sup>(2)</sup> |      | 0.8  |      |
|                                  |                                 | DYA package  | I/O to GND <sup>(2)</sup> |      | 0.8  |      |
|                                  |                                 |  | GND to I/O <sup>(2)</sup> |      | 0.7  |      |
|                                  |                                 | DQA package  | I/O to GND <sup>(2)</sup> |      | 0.8  |      |
|                                  |                                 |  | GND to I/O <sup>(2)</sup> |      | 0.8  |      |
|                                  |                                 | RVZ package  | I/O to GND <sup>(2)</sup> |      | 0.8  |      |
|                                  |                                 |  | GND to I/O <sup>(2)</sup> |      | 0.8  |      |
| <b>CAPACITANCE</b>               |                                 |  |                           |      |      |      |
| C <sub>L</sub>                   | Line capacitance <sup>(3)</sup> | V <sub>IO</sub> = 2.5 V; f = 1 MHz, I/O to GND                                       | TPD1E05U06 DPY package    |      | 0.42 | pF   |
|                                  |                                 |  | TPD1E05U06 DYA package    |      | 0.42 |      |
|                                  |                                 |  | TPD4E05U06 DQA package    |      | 0.5  |      |
|                                  |                                 |  | TPD6E05U06 RVZ package    |      | 0.47 |      |
| Δ C <sub>IO-TO-GND</sub>         | Variation of input capacitance  | GND Pin = 0 V, f = 1 MHz, VBIAS = 2.5 V, Channel x pin to GND – channel y pin to GND |                           | 0.05 | 0.07 | pF   |

## 6.4 Electrical Characteristics (continued)

over operating free-air temperature range (unless otherwise noted)

| PARAMETER              |                                      | TEST CONDITION   | MIN | TYP  | MAX  | UNIT |
|------------------------|--------------------------------------|--|-----|------|------|------|
| C <sub>CROS</sub><br>s | Channel to channel input capacitance | GND Pin = 0 V, f = 1 MHz, VBIAS = 2.5 V,<br>between channel pins |     | 0.01 | 0.06 | pF   |

- (1) Transition line pulse with 100 ns width, 200 ps rise time.
- (2) Extraction of R<sub>DYN</sub> using least squares fit of TLP characteristics between I = 10 A and I = 20 A.
- (3) Capacitance data is taken at 25°C.



## 6.5 Typical Characteristics

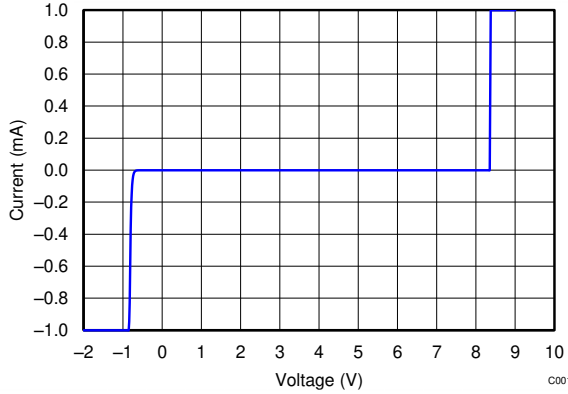

Figure 6-1. DC Voltage Sweep I-V Curve

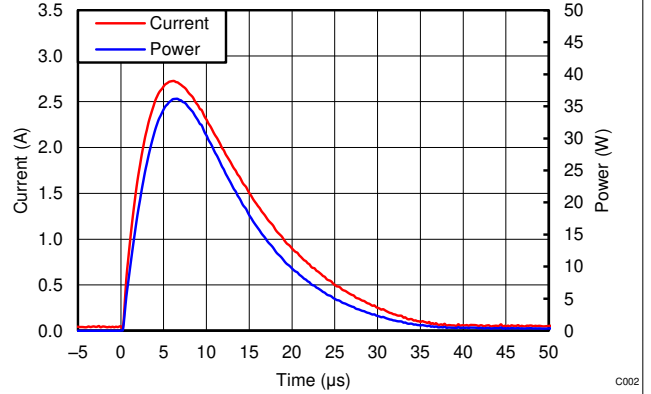

Figure 6-2. Surge Curve ( $t_p = 8/20 \mu s$ ), Pin IO to GND

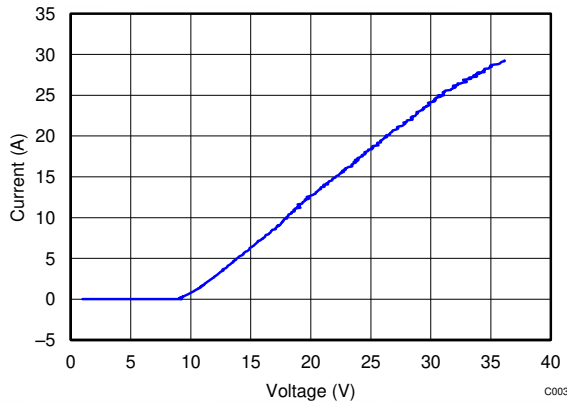

Figure 6-3. Positive TLP Plot IO to GND

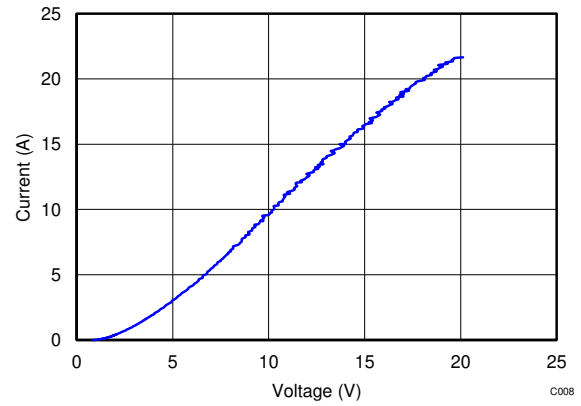

Figure 6-4. Negative TLP Plot IO to GND

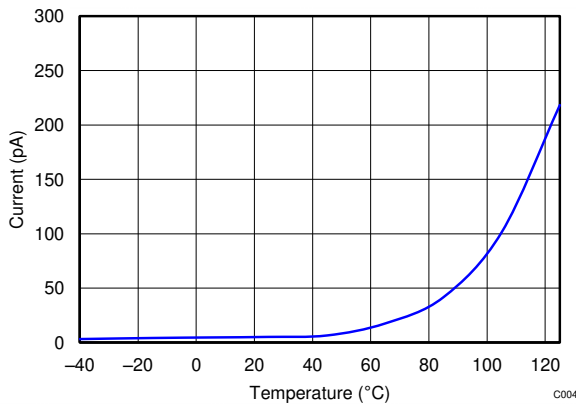

Figure 6-5. Leakage vs Temperature

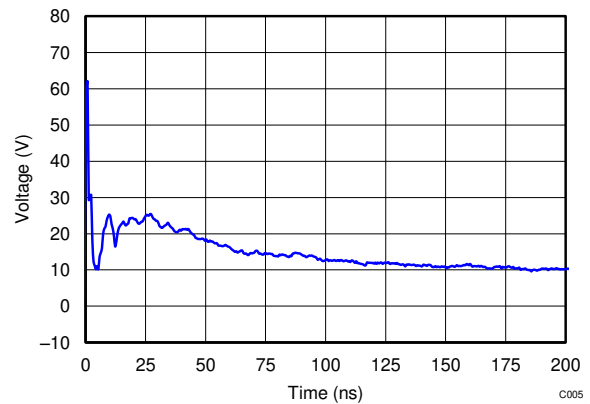

Figure 6-6. 8-kV IEC Waveform

## 6.5 Typical Characteristics (continued)

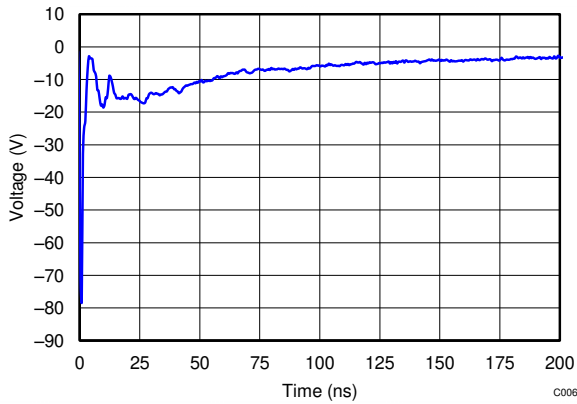

Figure 6-7. -8-kV IEC Waveform

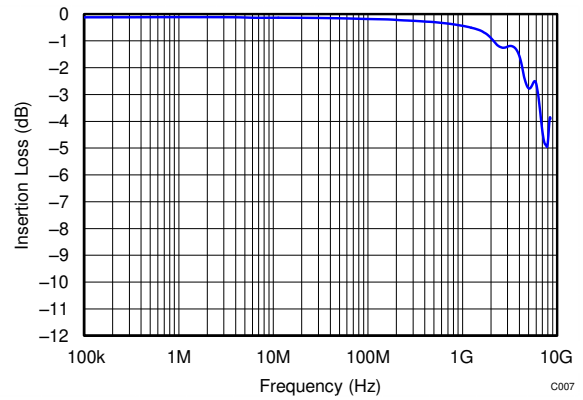

Figure 6-8. TPD1E05U06 Insertion Loss

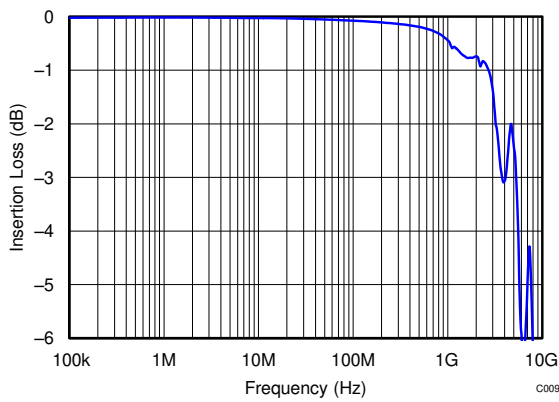

Figure 6-9. TPD4E05U06 Insertion Loss

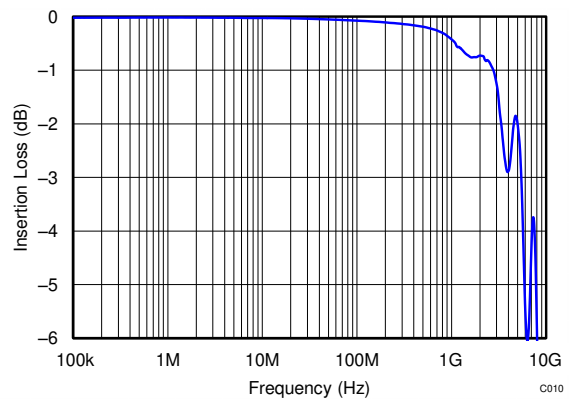

Figure 6-10. TPD6E05U06 Insertion Loss

## 7 Detailed Description

### 7.1 Overview

The TPDxE05U06 is a family of unidirectional Transient Voltage Suppressor (TVS) based Electrostatic Discharge (ESD) protection diodes with ultra-low capacitance. Each device can dissipate ESD strikes above the maximum level specified by the IEC 61000-4-2 international standard. The TPDxE05U06s ultra-low loading capacitance makes it ideal for protecting any high-speed signal pins.

### 7.2 Functional Block Diagram

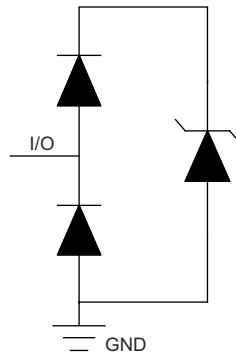

**Figure 7-1. TPD1E05U06 Block Diagram**

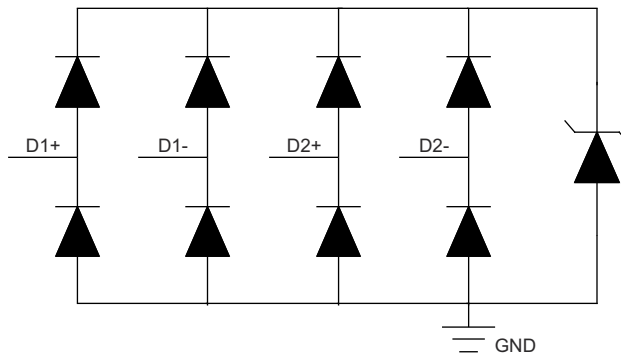

**Figure 7-2. TPD4E05U06 Block Diagram**

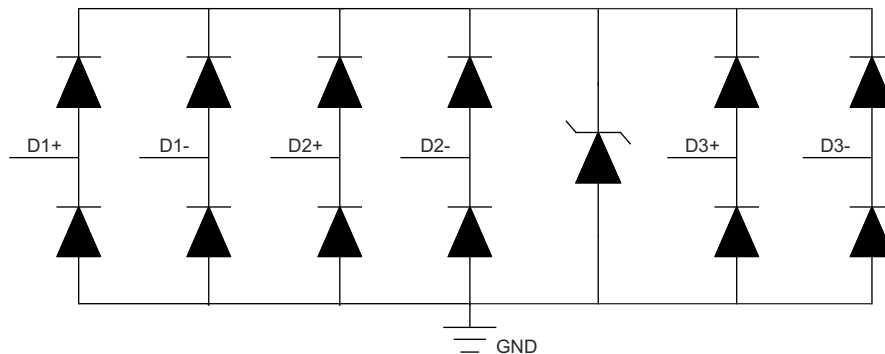

**Figure 7-3. TPD6E05U06 Block Diagram**

## 7.3 Feature Description

The TPDxE05U06 is a family of unidirectional Transient Voltage Suppressor (TVS) Electrostatic Discharge (ESD) protection diodes with ultra-low capacitance. Each device can dissipate ESD strikes above the maximum level specified by the IEC 61000-4-2 international standard. The TPDxE05U06s ultra-low loading capacitance makes it ideal for protecting any high-speed signal pins.

### 7.3.1 ±15-kV IEC61000-4-2 Level 4 ESD Protection

The I/O pins can withstand ESD events up to ±12-kV contact and ±15-kV air. An ESD-surge clamp diverts the current to ground.

### 7.3.2 IEC61000-4-4 EFT Protection

The I/O pins can withstand an electrical fast transient burst of up to 80 A (5/50 ns waveform, 4 kV with 50-Ω impedance). An ESD-surge clamp diverts the current to ground. This has been validated on the TPD4E05U06 only.

### 7.3.3 IEC61000-4-5 Surge Protection

The I/O pins can withstand surge events up to 2.5 A and 40 W (8/20 μs waveform). An ESD-surge clamp diverts this current to ground.

### 7.3.4 I/O Capacitance

The capacitance between each I/O pin to ground is 0.42 pF (TPD1E05U06), 0.5 pF (TPD4E05U06) or 0.47 pF (TPD6E05U06). These devices support data rates up to 6 Gbps.

### 7.3.5 DC Breakdown Voltage

The DC breakdown voltage of each I/O pin is a minimum of 6.5 V. This ensures that sensitive equipment is protected from surges above the reverse standoff voltage of 5.5 V.

### 7.3.6 Ultra-Low Leakage Current

The I/O pins feature an ultra-low leakage current of 10 nA (maximum) with a bias of 2.5 V.

### 7.3.7 Low ESD Clamping Voltage

The I/O pins feature an ESD clamp that is capable of clamping the voltage to 10 V ( $I_{PP} = 1$  A).

### 7.3.8 Industrial Temperature Range

This device features an industrial operating range of –40°C to +125°C.

### 7.3.9 Easy Flow-Through Routing

The layout of this device makes it simple and easy to add protection to an existing layout. The packages offers flow-through routing, requiring minimal modification to an existing layout.

## 7.4 Device Functional Modes

The TPDxE05U06 is a passive integrated circuit that triggers when voltages are above VBR or below the lower diodes  $V_f$  (–0.6 V). During ESD events, voltages as high as ±15 kV (air) can be directed to ground via the internal diode network. When the voltages on the protected line fall below the trigger levels of TPDxE05U06 (usually within 10s of nano-seconds) the device reverts to passive.

## 8 Application and Implementation

### Note

Information in the following applications sections is not part of the TI component specification, and TI does not warrant its accuracy or completeness. TI's customers are responsible for determining suitability of components for their purposes, as well as validating and testing their design implementation to confirm system functionality.

### 8.1 Application Information

The TPDxE05U06 is a diode type TVS which is typically used to provide a path to ground for dissipating ESD events on hi-speed signal lines between a human interface connector and a system. As the current from ESD passes through the TVS, only a small voltage drop is present across the diode. This is the voltage presented to the protected IC. The low  $R_{DYN}$  of the triggered TVS holds this voltage,  $V_{CLAMP}$ , to a safe level for the protected IC.

### 8.2 Typical Applications

#### 8.2.1 HDMI 2.0 Application

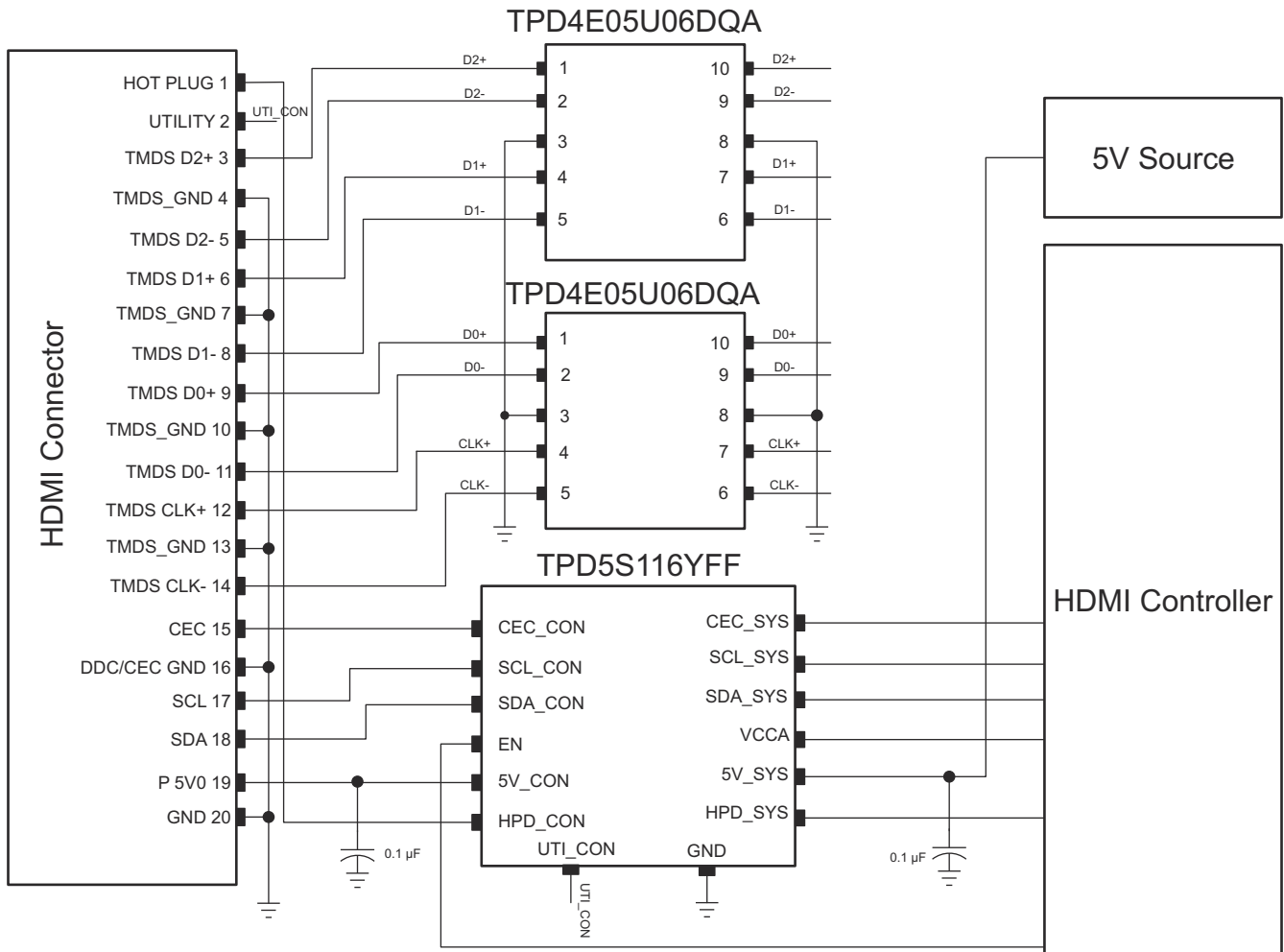

Figure 8-1. HDMI 2.0 Schematic

### 8.2.1.1 Design Requirements

For this design example, the two TPD4E05U06 devices, and a TPD5S116 are being used in an HDMI 2.0 application. This provides a complete port protection scheme.

Given the HDMI 2.0 application, the parameters listed in [Table 8-1](#) are known.

**Table 8-1. Design Parameters**

| DESIGN PARAMETER                   | VALUE      |
|------------------------------------|------------|
| Signal range on pins 1, 2, 4, or 5 | 0 V to 5 V |
| Operating frequency                | 3 GHz      |

### 8.2.1.2 Detailed Design Procedure

#### 8.2.1.2.1 Signal Range on Pin 1, 2, 4, or 5

The TPD4E05U06 has 4 identical protection channels for signal lines. The symmetry of the device provides flexibility when selecting which of the 4 I/O channels is going to protect which signal lines. Any I/O supports a signal range of 0 to 5.5 V.

### 8.2.1.3 Application Curves

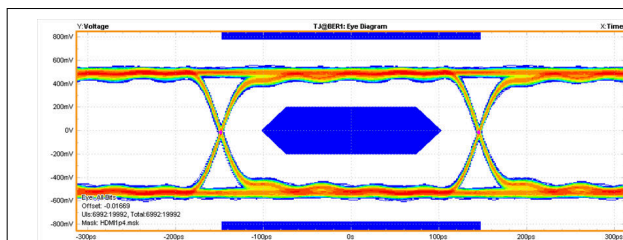

**Figure 8-2. 3.4-Gbps HDMI 1.4 TP1 Eye Diagram Unpopulated EVM**

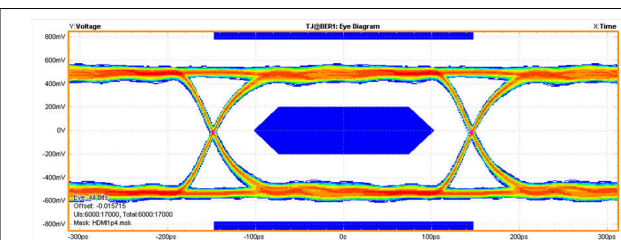

**Figure 8-3. 3.4-Gbps HDMI 1.4 TP1 Eye Diagram TPD1E05U06**

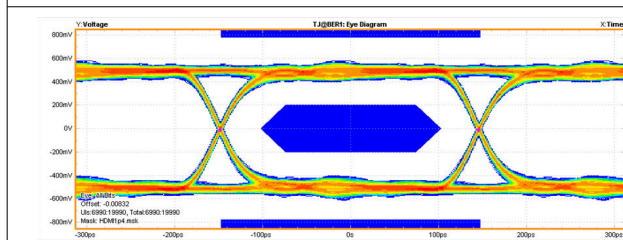

**Figure 8-4. 3.4-Gbps HDMI 1.4 TP1 Eye Diagram TPD4E05U06**

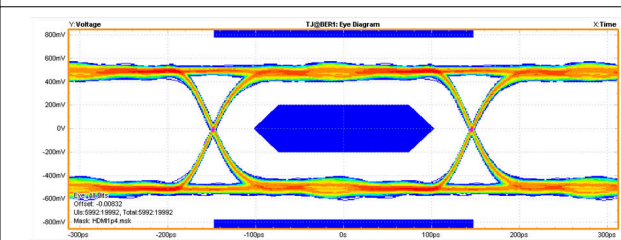

**Figure 8-5. 3.4-Gbps HDMI 1.4 TP1 Eye Diagram TPD6E05U06**

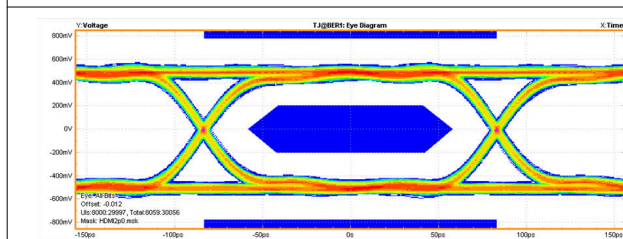

**Figure 8-6. 6-Gbps HDMI 2.0 (TP1) Eye Diagram Unpopulated EVM**

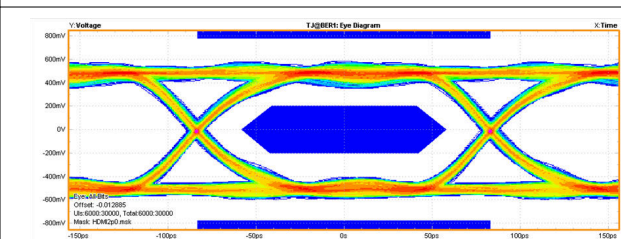

**Figure 8-7. 6-Gbps HDMI 2.0 (TP1) Eye Diagram TPD1E05U06**

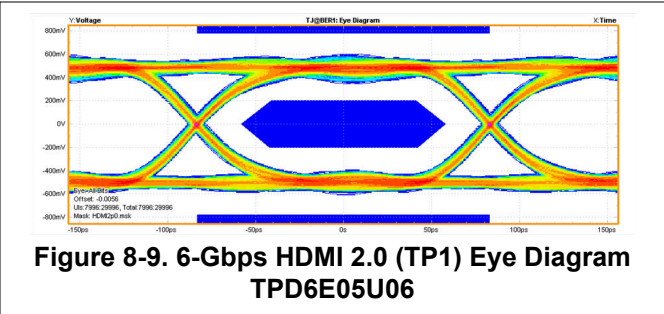
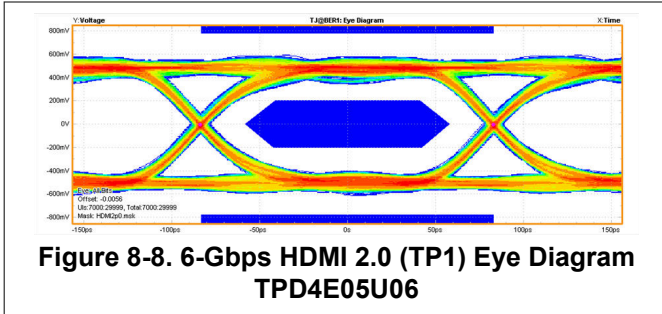

### 8.2.2 HDMI 2.0 Application

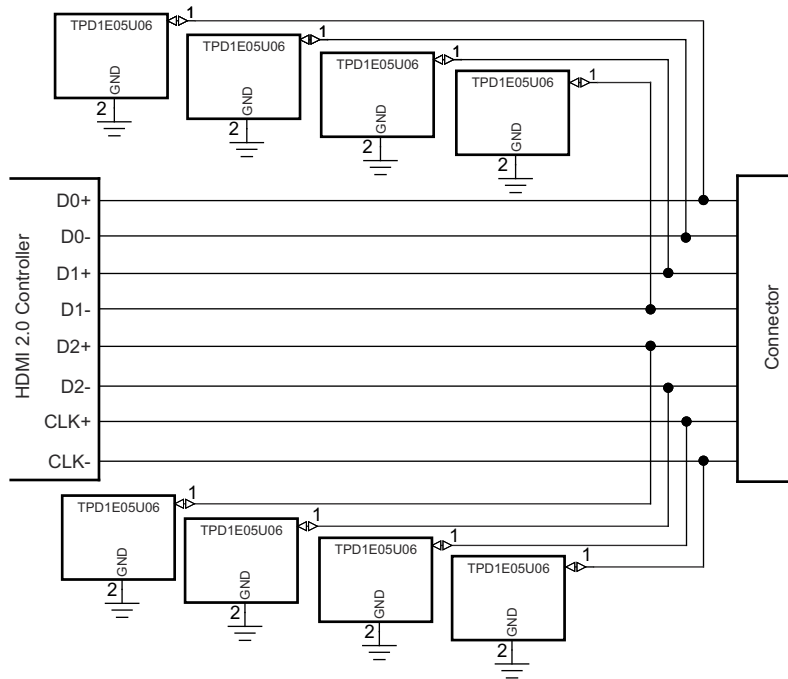

**Figure 8-10. HDMI 2.0 Schematic**

### 8.2.2.1 Design Requirements

For this design example, the TPD1E05U06 and the TPD5S116 are used to protect the data pairs and control lines of the HDMI 2.0 connection. This provides full HDMI 2.0 port protection.

Given the HDMI 2.0 application, the following parameters in [Table 8-2](#) are known.

**Table 8-2. Design Parameters**

| DESIGN PARAMETER           | VALUE      |
|----------------------------|------------|
| Signal range on data lines | 0 V to 5 V |
| Operating frequency        | 3 GHz      |

### 8.2.2.2 Detailed Design Procedure

#### 8.2.2.2.1 Signal Range

The TPD1E05U06 has 1 protection channel for signal lines, supporting a signal range of 0 V to 5.5 V.

#### 8.2.2.2.2 Operating Frequency

The TPD1E05U06 has 0.42 pF of capacitance, which supports HDMI 2.0 data rates.

#### 8.2.2.3 Application Curves

Refer to the [Section 8.2.1.3](#) section.

## 9 Power Supply Recommendations

This device is a passive ESD protection device and there is no need to power it. Care must be taken to make sure that the maximum voltage specifications for each line are not violated.



## 10 Layout

### 10.1 Layout Guidelines

- The optimum placement is as close to the connector as possible.
  - EMI during an ESD event can couple from the trace being struck to other nearby unprotected traces, resulting in early system failures.
  - The PCB designer needs to minimize the possibility of EMI coupling by keeping any unprotected traces away from the protected traces which are between the TVS and the connector.
- Route the protected traces as straight as possible.
- Eliminate any sharp corners on the protected traces between the TVS and the connector by using rounded corners with the largest radii possible.
  - Electric fields tend to build up on corners, increasing EMI coupling.

### 10.2 Layout Example

#### 10.2.1 TPD4E05U06 Layout Example

This application is typical of an HDMI 1.4 layout.

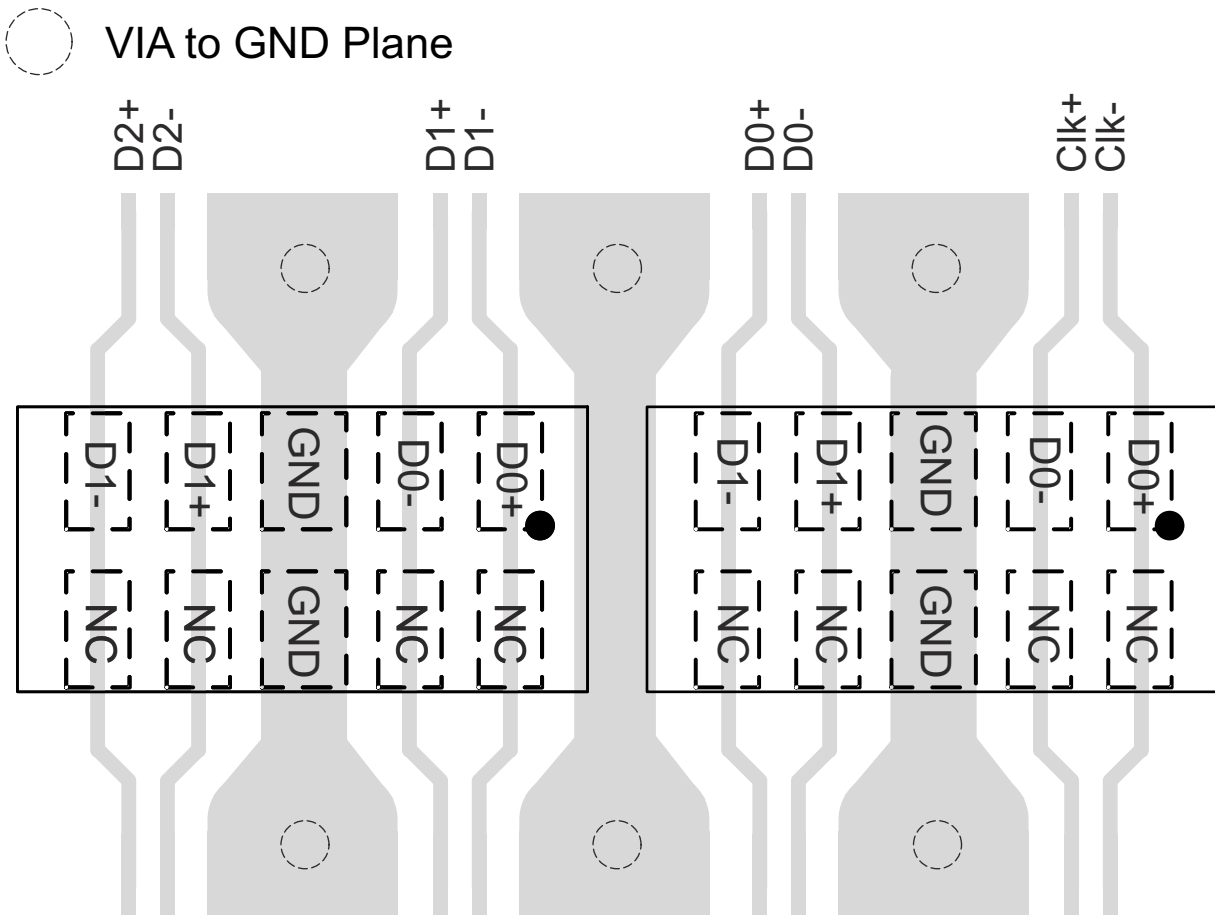

Figure 10-1. TPD4E05U06 Layout

### 10.2.2 TPD1E05U06 Layout Example

This application is typical of an HDMI 2.0 layout.

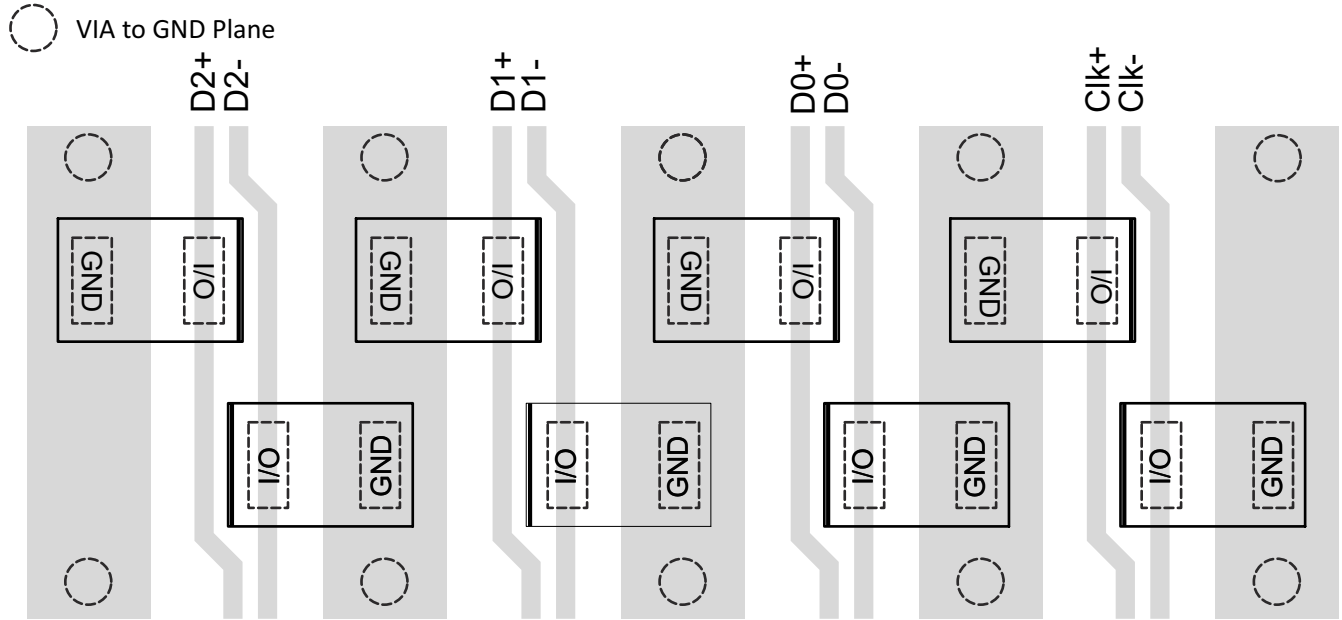

Figure 10-2. TPD1E05U06 Layout

## 11 Device and Documentation Support

### 11.1 Documentation Support

#### 11.1.1 Related Documentation

For related documentation, see the following:

- Texas Instruments, [Reading and Understanding an ESD Protection data sheet](#)
- Texas Instruments, [ESD Layout Guide application reports](#)
- Texas Instruments, [TPD6E05U06RVZ EVM user's guide](#)
- Texas Instruments, [Picking ESD Diodes for Ultra High-Speed Data Lines application reports](#)
- Texas Instruments, [ESD PROTECTION DIODES EVM user's guide](#)
- Texas Instruments, [TPD1E05U06DPY EVM user's guide](#)
- Texas Instruments, [TPD4E05U06DQA EVM user's guide](#)
- Texas Instruments, [Generic ESD Evaluation Module user's guide](#)

#### 11.2 Receiving Notification of Documentation Updates

To receive notification of documentation updates, navigate to the device product folder on [ti.com](#). Click on *Subscribe to updates* to register and receive a weekly digest of any product information that has changed. For change details, review the revision history included in any revised document.

#### 11.3 Support Resources

[TI E2E™ support forums](#) are an engineer's go-to source for fast, verified answers and design help — straight from the experts. Search existing answers or ask your own question to get the quick design help you need.

Linked content is provided "AS IS" by the respective contributors. They do not constitute TI specifications and do not necessarily reflect TI's views; see TI's [Terms of Use](#).

#### 11.4 Trademarks

TI E2E™ is a trademark of Texas Instruments.

PCI-express® and PCI-Express® are registered trademarks of PCI-SIG .

V-by-One® is a registered trademark of Thine Electronics, Inc.

All trademarks are the property of their respective owners.

#### 11.5 Electrostatic Discharge Caution



This integrated circuit can be damaged by ESD. Texas Instruments recommends that all integrated circuits be handled with appropriate precautions. Failure to observe proper handling and installation procedures can cause damage.

ESD damage can range from subtle performance degradation to complete device failure. Precision integrated circuits may be more susceptible to damage because very small parametric changes could cause the device not to meet its published specifications.

#### 11.6 Glossary

[TI Glossary](#) This glossary lists and explains terms, acronyms, and definitions.

## 12 Mechanical, Packaging, and Orderable Information

The following pages include mechanical, packaging, and orderable information. This information is the most current data available for the designated devices. This data is subject to change without notice and revision of this document. For browser-based versions of this data sheet, refer to the left-hand navigation.

## PACKAGING INFORMATION

| Orderable Device | Status<br>(1) | Package Type | Package Drawing | Pins | Package Qty | Eco Plan<br>(2) | Lead finish/<br>Ball material<br>(6) | MSL Peak Temp<br>(3) | Op Temp (°C) | Device Marking<br>(4/5) | Samples                 |
|------------------|---------------|--------------|-----------------|------|-------------|-----------------|--------------------------------------|----------------------|--------------|-------------------------|-------------------------|
| TPD1E05U06DPYR   | ACTIVE        | X1SON        | DPY             | 2    | 10000       | RoHS & Green    | NIPDAU                               | Level-1-260C-UNLIM   | -40 to 125   | (BK, C1, C6)<br>C2      | <a href="#">Samples</a> |
| TPD1E05U06DPYT   | ACTIVE        | X1SON        | DPY             | 2    | 250         | RoHS & Green    | NIPDAU                               | Level-1-260C-UNLIM   | -40 to 125   | (BK, C1, C6)<br>C2      | <a href="#">Samples</a> |
| TPD1E05U06DYAR   | ACTIVE        | SOT-5X3      | DYA             | 2    | 3000        | RoHS & Green    | SN                                   | Level-3-260C-168 HR  | -40 to 125   | 1KS                     | <a href="#">Samples</a> |
| TPD4E05U06DQAR   | ACTIVE        | USON         | DQA             | 10   | 3000        | RoHS & Green    | NIPDAU                               | Level-1-260C-UNLIM   | -40 to 125   | (BLG, BRG)<br>BRY       | <a href="#">Samples</a> |
| TPD6E05U06RVZR   | ACTIVE        | USON         | RVZ             | 14   | 3000        | RoHS & Green    | NIPDAU                               | Level-1-260C-UNLIM   | -40 to 125   | (BV, BVY)               | <a href="#">Samples</a> |

(1) The marketing status values are defined as follows:

**ACTIVE:** Product device recommended for new designs.

**LIFEBUY:** TI has announced that the device will be discontinued, and a lifetime-buy period is in effect.

**NRND:** Not recommended for new designs. Device is in production to support existing customers, but TI does not recommend using this part in a new design.

**PREVIEW:** Device has been announced but is not in production. Samples may or may not be available.

**OBSELETE:** TI has discontinued the production of the device.

(2) **RoHS:** TI defines "RoHS" to mean semiconductor products that are compliant with the current EU RoHS requirements for all 10 RoHS substances, including the requirement that RoHS substance do not exceed 0.1% by weight in homogeneous materials. Where designed to be soldered at high temperatures, "RoHS" products are suitable for use in specified lead-free processes. TI may reference these types of products as "Pb-Free".

**RoHS Exempt:** TI defines "RoHS Exempt" to mean products that contain lead but are compliant with EU RoHS pursuant to a specific EU RoHS exemption.

**Green:** TI defines "Green" to mean the content of Chlorine (Cl) and Bromine (Br) based flame retardants meet JS709B low halogen requirements of <=1000ppm threshold. Antimony trioxide based flame retardants must also meet the <=1000ppm threshold requirement.

(3) MSL, Peak Temp. - The Moisture Sensitivity Level rating according to the JEDEC industry standard classifications, and peak solder temperature.

(4) There may be additional marking, which relates to the logo, the lot trace code information, or the environmental category on the device.

(5) Multiple Device Markings will be inside parentheses. Only one Device Marking contained in parentheses and separated by a "-" will appear on a device. If a line is indented then it is a continuation of the previous line and the two combined represent the entire Device Marking for that device.

(6) Lead finish/Ball material - Orderable Devices may have multiple material finish options. Finish options are separated by a vertical ruled line. Lead finish/Ball material values may wrap to two lines if the finish value exceeds the maximum column width.

**Important Information and Disclaimer:** The information provided on this page represents TI's knowledge and belief as of the date that it is provided. TI bases its knowledge and belief on information provided by third parties, and makes no representation or warranty as to the accuracy of such information. Efforts are underway to better integrate information from third parties. TI has taken and continues to take reasonable steps to provide representative and accurate information but may not have conducted destructive testing or chemical analysis on incoming materials and chemicals. TI and TI suppliers consider certain information to be proprietary, and thus CAS numbers and other limited information may not be available for release.

In no event shall TI's liability arising out of such information exceed the total purchase price of the TI part(s) at issue in this document sold by TI to Customer on an annual basis.

**OTHER QUALIFIED VERSIONS OF TPD1E05U06, TPD4E05U06 :**

- Automotive : [TPD1E05U06-Q1](#), [TPD4E05U06-Q1](#)

NOTE: Qualified Version Definitions:

- Automotive - Q100 devices qualified for high-reliability automotive applications targeting zero defects

## TAPE AND REEL INFORMATION



### QUADRANT ASSIGNMENTS FOR PIN 1 ORIENTATION IN TAPE

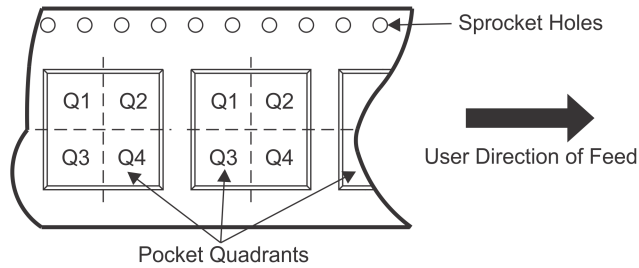

\*All dimensions are nominal

| Device         | Package Type | Package Drawing | Pins | SPQ   | Reel Diameter (mm) | Reel Width W1 (mm) | A0 (mm) | B0 (mm) | K0 (mm) | P1 (mm) | W (mm) | Pin1 Quadrant |
|----------------|--------------|-----------------|------|-------|--------------------|--------------------|---------|---------|---------|---------|--------|---------------|
| TPD1E05U06DPYR | X1SON        | DPY             | 2    | 10000 | 180.0              | 9.5                | 0.66    | 1.15    | 0.66    | 2.0     | 8.0    | Q1            |
| TPD1E05U06DPYR | X1SON        | DPY             | 2    | 10000 | 180.0              | 9.5                | 0.73    | 1.13    | 0.5     | 2.0     | 8.0    | Q1            |
| TPD1E05U06DPYR | X1SON        | DPY             | 2    | 10000 | 180.0              | 8.4                | 0.07    | 1.1     | 0.47    | 2.0     | 8.0    | Q1            |
| TPD1E05U06DPYT | X1SON        | DPY             | 2    | 250   | 180.0              | 8.4                | 0.07    | 1.1     | 0.47    | 2.0     | 8.0    | Q1            |
| TPD1E05U06DPYT | X1SON        | DPY             | 2    | 250   | 180.0              | 9.5                | 0.66    | 1.15    | 0.66    | 2.0     | 8.0    | Q1            |
| TPD1E05U06DYAR | SOT-5X3      | DYA             | 2    | 3000  | 178.0              | 9.5                | 0.5     | 1.94    | 0.73    | 4.0     | 8.0    | Q1            |
| TPD4E05U06DQAR | USON         | DQA             | 10   | 3000  | 180.0              | 9.5                | 1.18    | 2.68    | 0.72    | 4.0     | 8.0    | Q1            |
| TPD4E05U06DQAR | USON         | DQA             | 10   | 3000  | 180.0              | 8.4                | 1.23    | 2.7     | 0.6     | 4.0     | 8.0    | Q1            |
| TPD4E05U06DQAR | USON         | DQA             | 10   | 3000  | 180.0              | 9.5                | 1.23    | 2.7     | 0.7     | 4.0     | 8.0    | Q1            |
| TPD6E05U06RVZR | USON         | RVZ             | 14   | 3000  | 178.0              | 13.5               | 1.6     | 3.75    | 0.7     | 4.0     | 12.0   | Q1            |
| TPD6E05U06RVZR | USON         | RVZ             | 14   | 3000  | 180.0              | 13.2               | 1.65    | 3.8     | 0.7     | 4.0     | 12.0   | Q1            |

**TAPE AND REEL BOX DIMENSIONS**

\*All dimensions are nominal

| Device         | Package Type | Package Drawing | Pins | SPQ   | Length (mm) | Width (mm) | Height (mm) |
|----------------|--------------|-----------------|------|-------|-------------|------------|-------------|
| TPD1E05U06DPYR | X1SON        | DPY             | 2    | 10000 | 184.0       | 184.0      | 19.0        |
| TPD1E05U06DPYR | X1SON        | DPY             | 2    | 10000 | 189.0       | 185.0      | 36.0        |
| TPD1E05U06DPYR | X1SON        | DPY             | 2    | 10000 | 203.2       | 196.8      | 33.3        |
| TPD1E05U06DPYT | X1SON        | DPY             | 2    | 250   | 203.2       | 196.8      | 33.3        |
| TPD1E05U06DPYT | X1SON        | DPY             | 2    | 250   | 184.0       | 184.0      | 19.0        |
| TPD1E05U06DYAR | SOT-5X3      | DYA             | 2    | 3000  | 210.0       | 200.0      | 42.0        |
| TPD4E05U06DQAR | USON         | DQA             | 10   | 3000  | 189.0       | 185.0      | 36.0        |
| TPD4E05U06DQAR | USON         | DQA             | 10   | 3000  | 203.2       | 196.8      | 33.3        |
| TPD4E05U06DQAR | USON         | DQA             | 10   | 3000  | 184.0       | 184.0      | 19.0        |
| TPD6E05U06RVZR | USON         | RVZ             | 14   | 3000  | 189.0       | 185.0      | 36.0        |
| TPD6E05U06RVZR | USON         | RVZ             | 14   | 3000  | 184.0       | 184.0      | 19.0        |

DPY (R-PX1SON-N2)

PLASTIC SMALL OUTLINE NO-LEAD

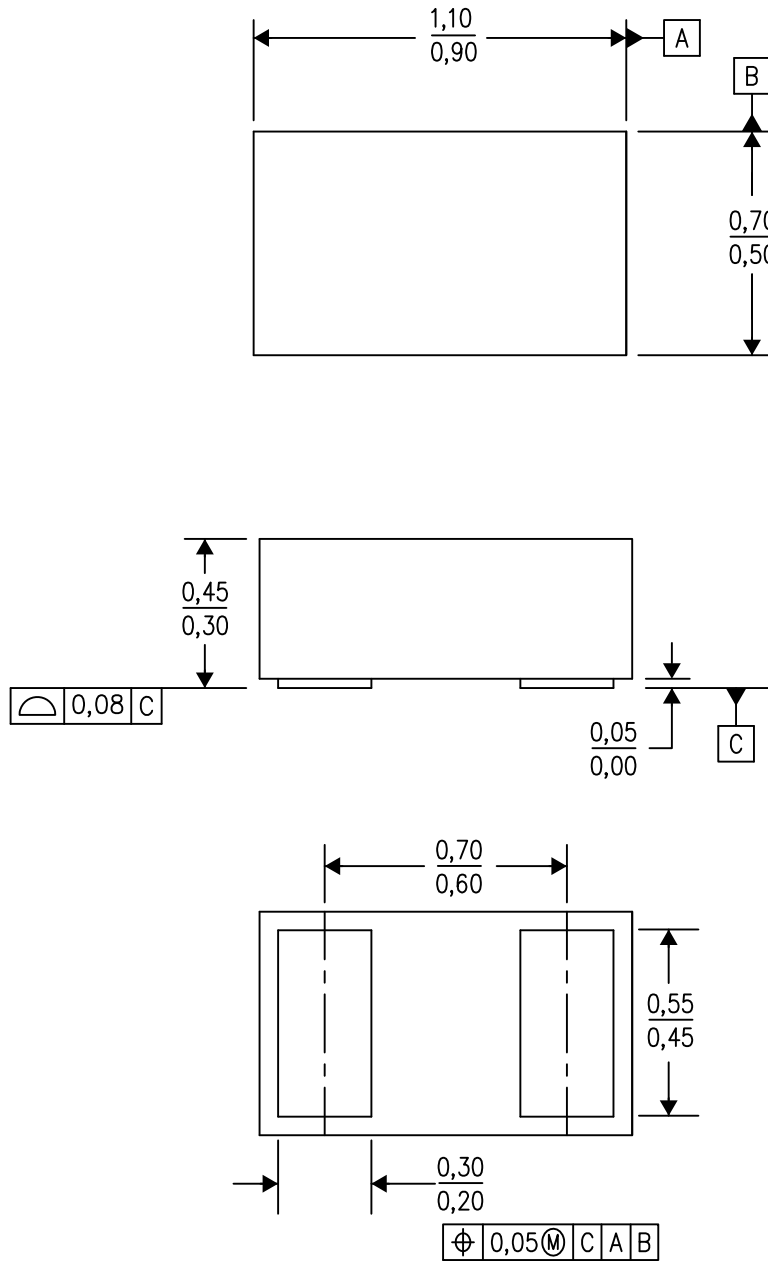

4211012/D 08/14

- NOTES:
- All linear dimensions are in millimeters. Dimensioning and tolerancing per ASME Y14.5-1994.
  - This drawing is subject to change without notice.
  - SON (Small Outline No-Lead) package configuration.



DPY0002A

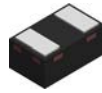

**PACKAGE OUTLINE**  
**X1SON - 0.45 mm max height**

PLASTIC SMALL OUTLINE - NO LEAD

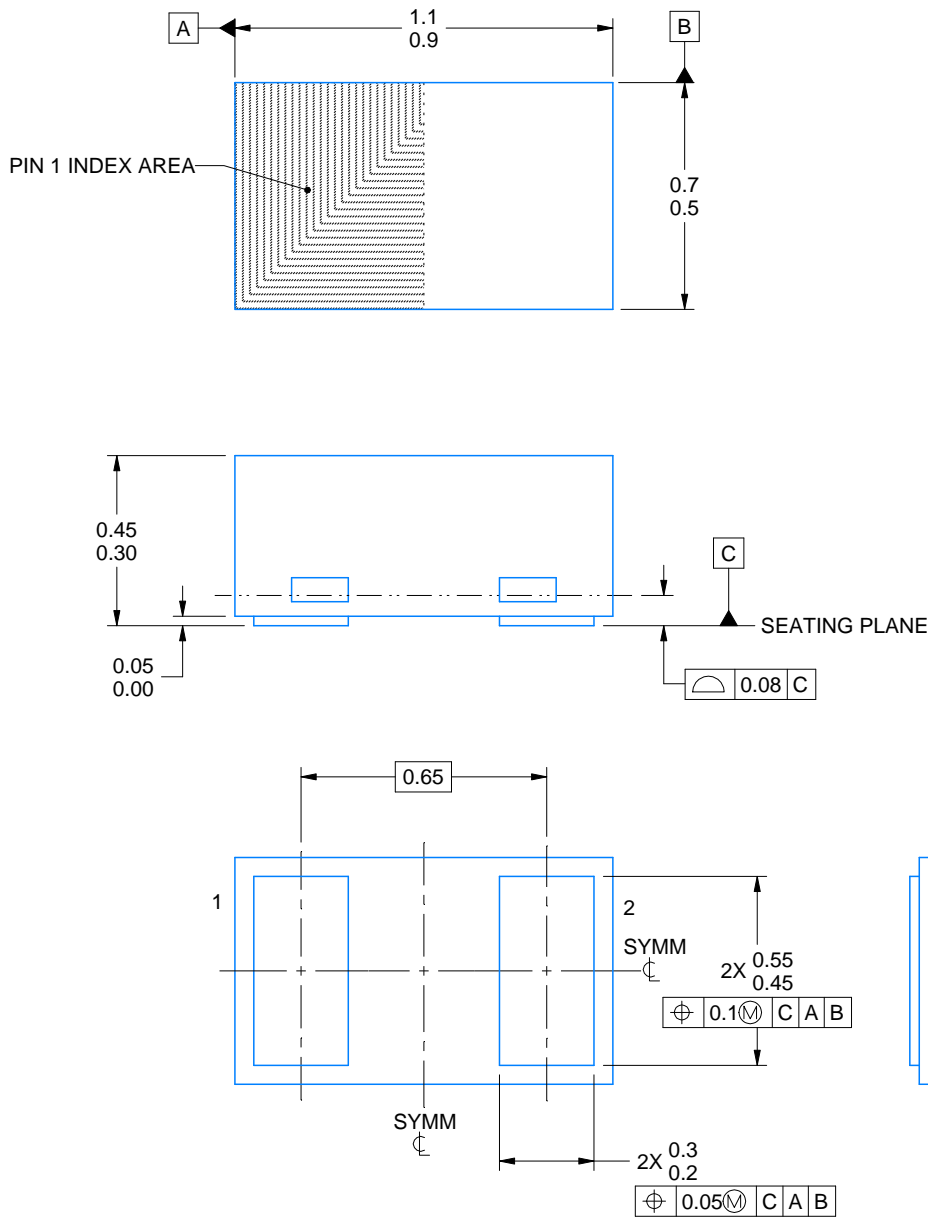

4224561/B 03/2021

NOTES:

1. All linear dimensions are in millimeters. Any dimensions in parenthesis are for reference only. Dimensioning and tolerancing per ASME Y14.5M
2. This drawing is subject to change without notice.

# EXAMPLE BOARD LAYOUT

DPY0002A

X1SON - 0.45 mm max height

PLASTIC SMALL OUTLINE - NO LEAD

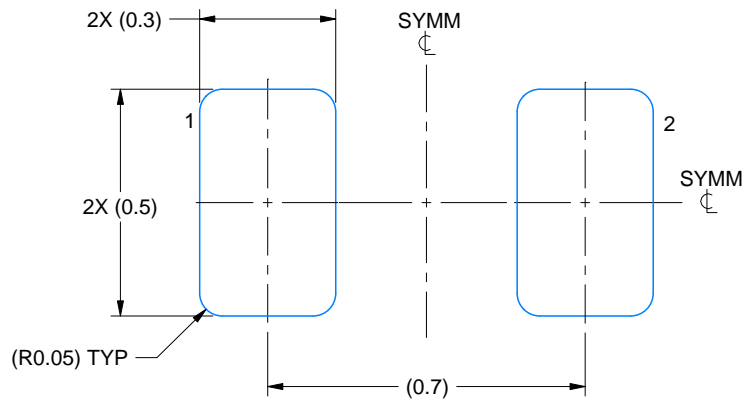

LAND PATTERN EXAMPLE  
EXPOSED METAL SHOWN  
SCALE:60X

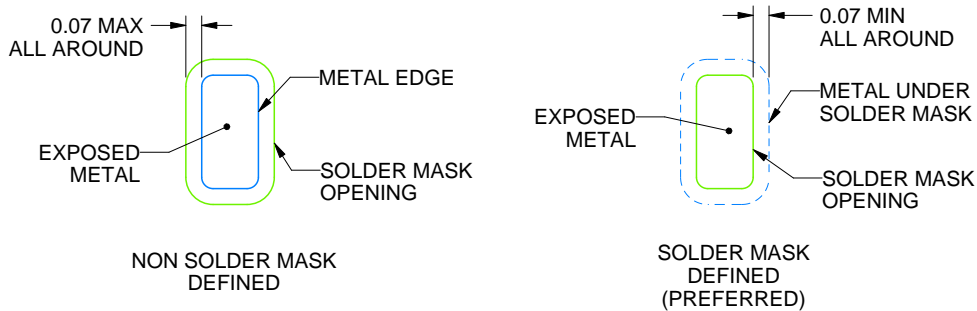

SOLDER MASK DETAILS

4224561/B 03/2021

NOTES: (continued)

3. For more information, see Texas Instruments literature number SLUA271 ([www.ti.com/lit/slue271](http://www.ti.com/lit/slue271)).
4. Vias are optional depending on application, refer to device data sheet. If any vias are implemented, refer to their locations shown on this view. It is recommended that vias under paste be filled, plugged or tented.

# EXAMPLE STENCIL DESIGN

DPY0002A

X1SON - 0.45 mm max height

PLASTIC SMALL OUTLINE - NO LEAD

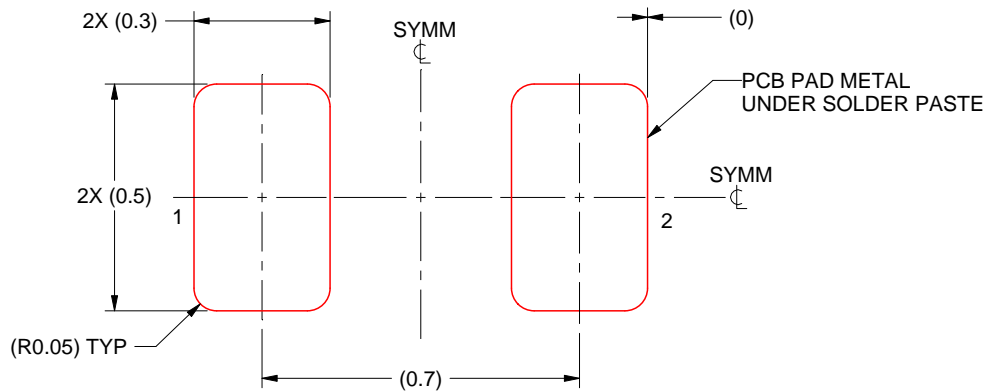

SOLDER PASTE EXAMPLE  
BASED ON 0.1 mm THICK STENCIL  
SCALE:60X

4224561/B 03/2021

NOTES: (continued)

5. Laser cutting apertures with trapezoidal walls and rounded corners may offer better paste release. IPC-7525 may have alternate design recommendations.

RVZ (R-PUSON-N14)

PLASTIC SMALL OUTLINE NO-LEAD

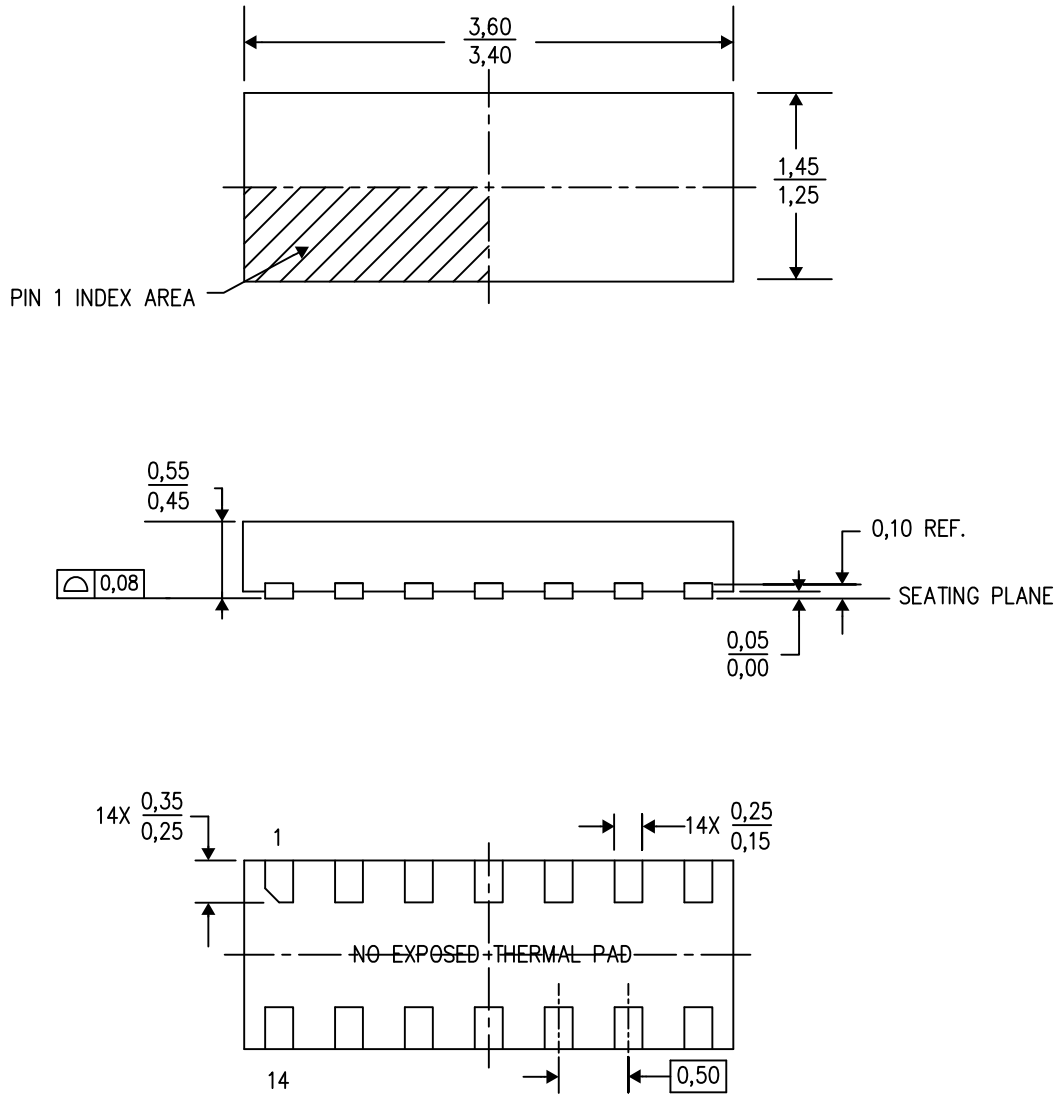

4218112/B 04/14

- NOTES:
- All linear dimensions are in millimeters. Dimensioning and tolerancing per ASME Y14.5M-1994.
  - This drawing is subject to change without notice.
  - QFN (Quad Flatpack No-Lead) package configuration.

RVZ (R-PUSON-N14)

PLASTIC SMALL OUTLINE NO-LEAD

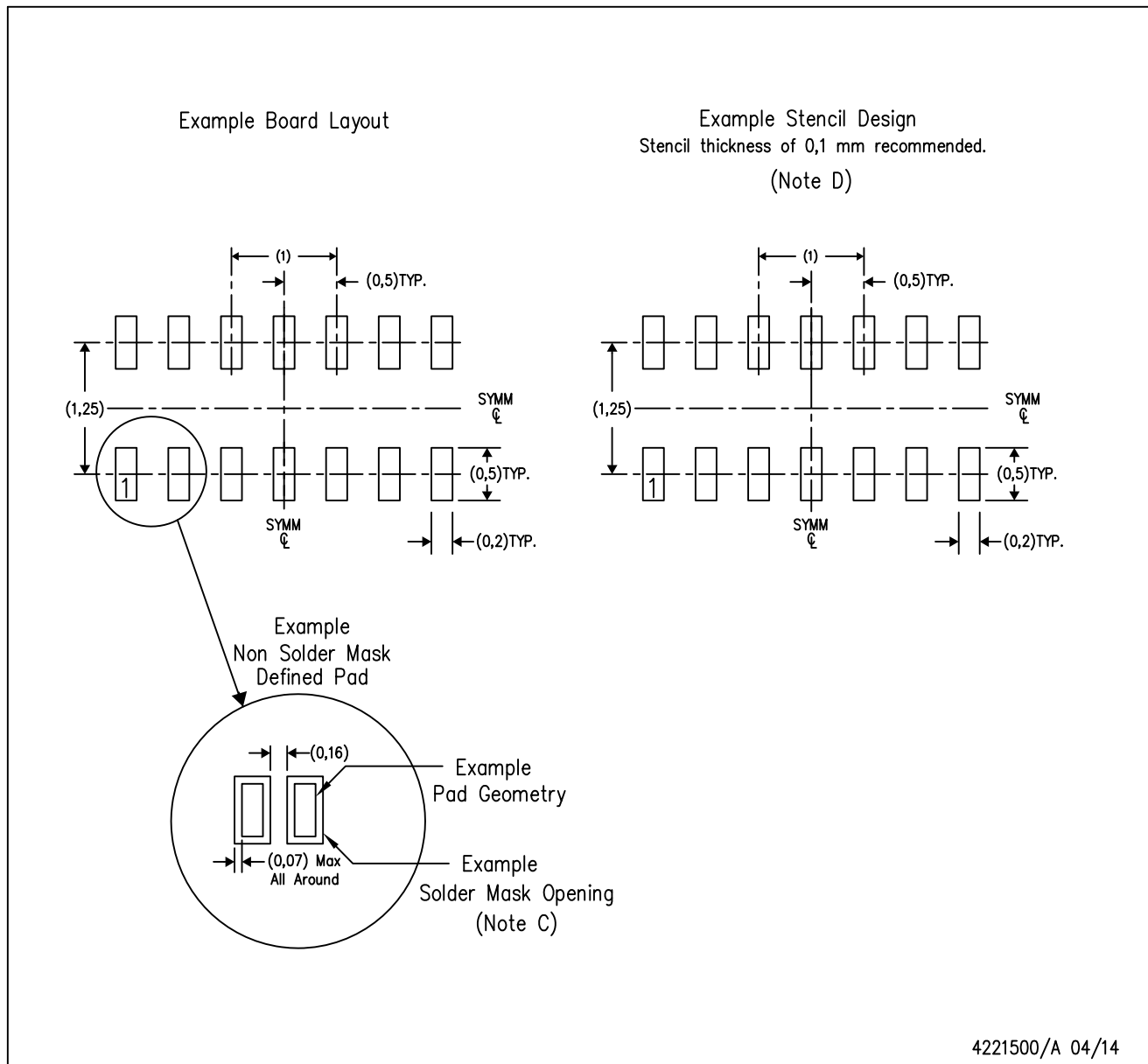

- NOTES:
- A. All linear dimensions are in millimeters.
  - B. This drawing is subject to change without notice.
  - C. Customers should contact their board fabrication site for minimum solder mask web tolerances between signal pads.
  - D. Laser cutting apertures with trapezoidal walls and also rounding corners will offer better paste release. Customers should contact their board assembly site for stencil design recommendations. Refer to IPC 7525 for stencil design considerations.

DYA0002A



# PACKAGE OUTLINE

SOT (SOD-523) - 0.77 mm max height

PLASTIC SMALL OUTLINE

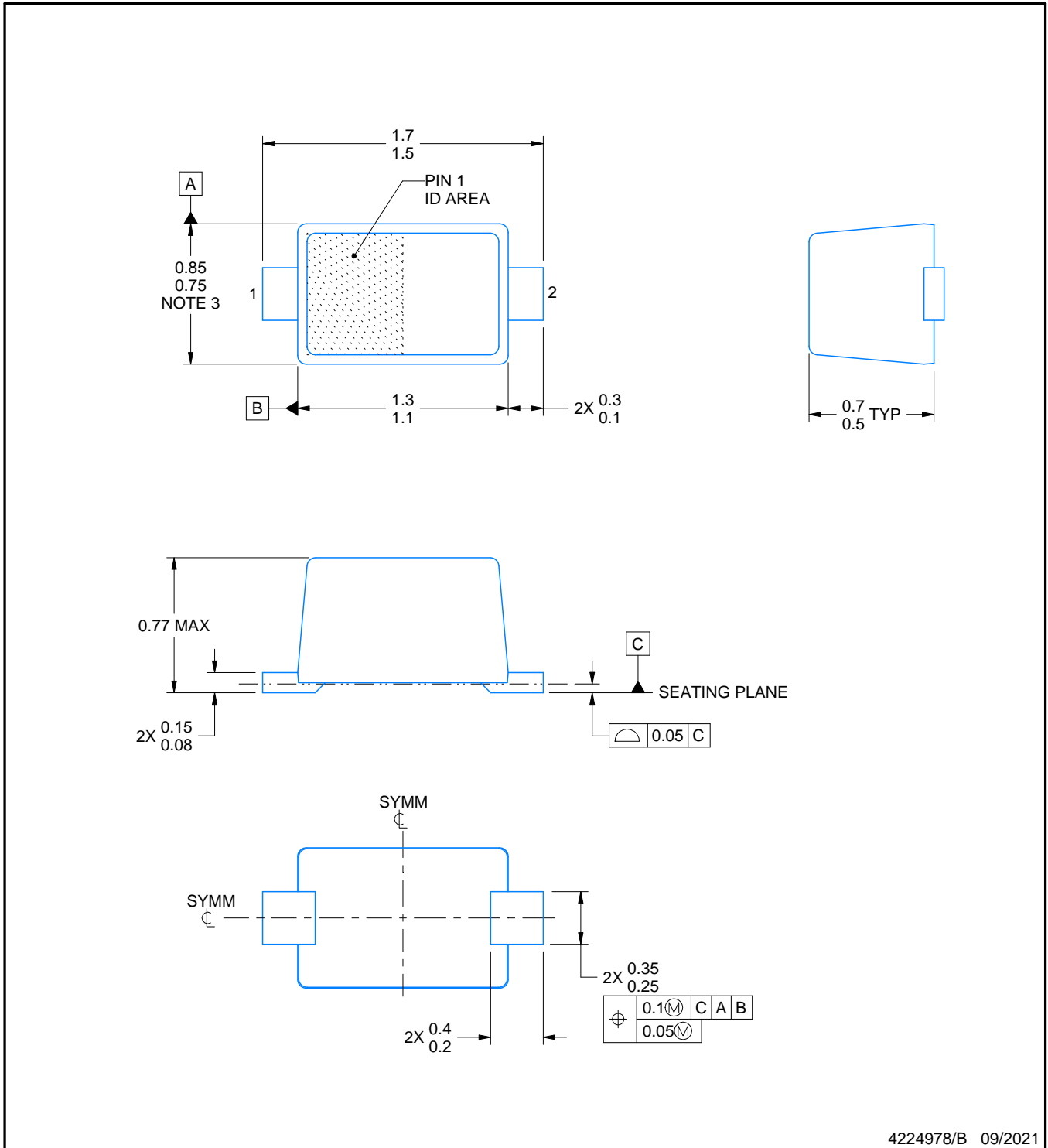

4224978/B 09/2021

NOTES:

1. All linear dimensions are in millimeters. Any dimensions in parenthesis are for reference only. Dimensioning and tolerancing per ASME Y14.5M.
2. This drawing is subject to change without notice.
3. This dimension does not include mold flash, protrusions, or gate burrs. Mold flash, protrusions, or gate burrs shall not exceed 0.15 mm per side.
4. Reference JEITA SC-79 registration except for package height

# EXAMPLE BOARD LAYOUT

DYA0002A

SOT (SOD-523) - 0.77 mm max height

PLASTIC SMALL OUTLINE

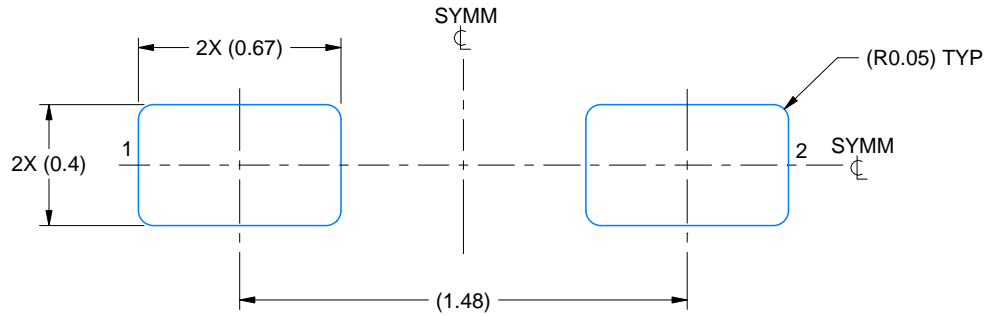

LAND PATTERN EXAMPLE  
SCALE:40X

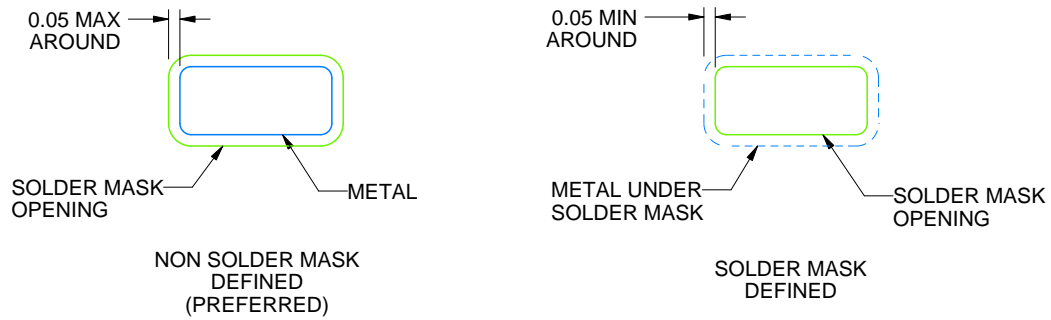

SOLDEMASK DETAILS

4224978/B 09/2021

NOTES: (continued)

- 5. Publication IPC-7351 may have alternate designs.
- 6. Solder mask tolerances between and around signal pads can vary based on board fabrication site.

# EXAMPLE STENCIL DESIGN

DYA0002A

SOT (SOD-523) - 0.77 mm max height

PLASTIC SMALL OUTLINE

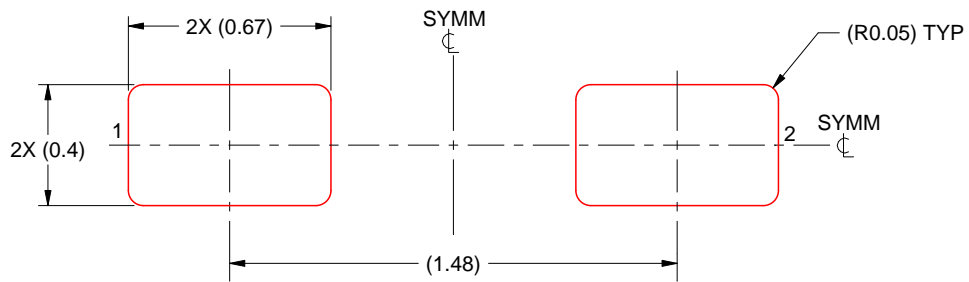

SOLDER PASTE EXAMPLE  
BASED ON 0.1 mm THICK STENCIL  
SCALE:40X

4224978/B 09/2021

NOTES: (continued)

7. Laser cutting apertures with trapezoidal walls and rounded corners may offer better paste release. IPC-7525 may have alternate design recommendations.
8. Board assembly site may have different recommendations for stencil design.



# DQA0010A

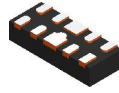

## PACKAGE OUTLINE

USON - 0.55 mm max height

PLASTIC SMALL OUTLINE - NO LEAD

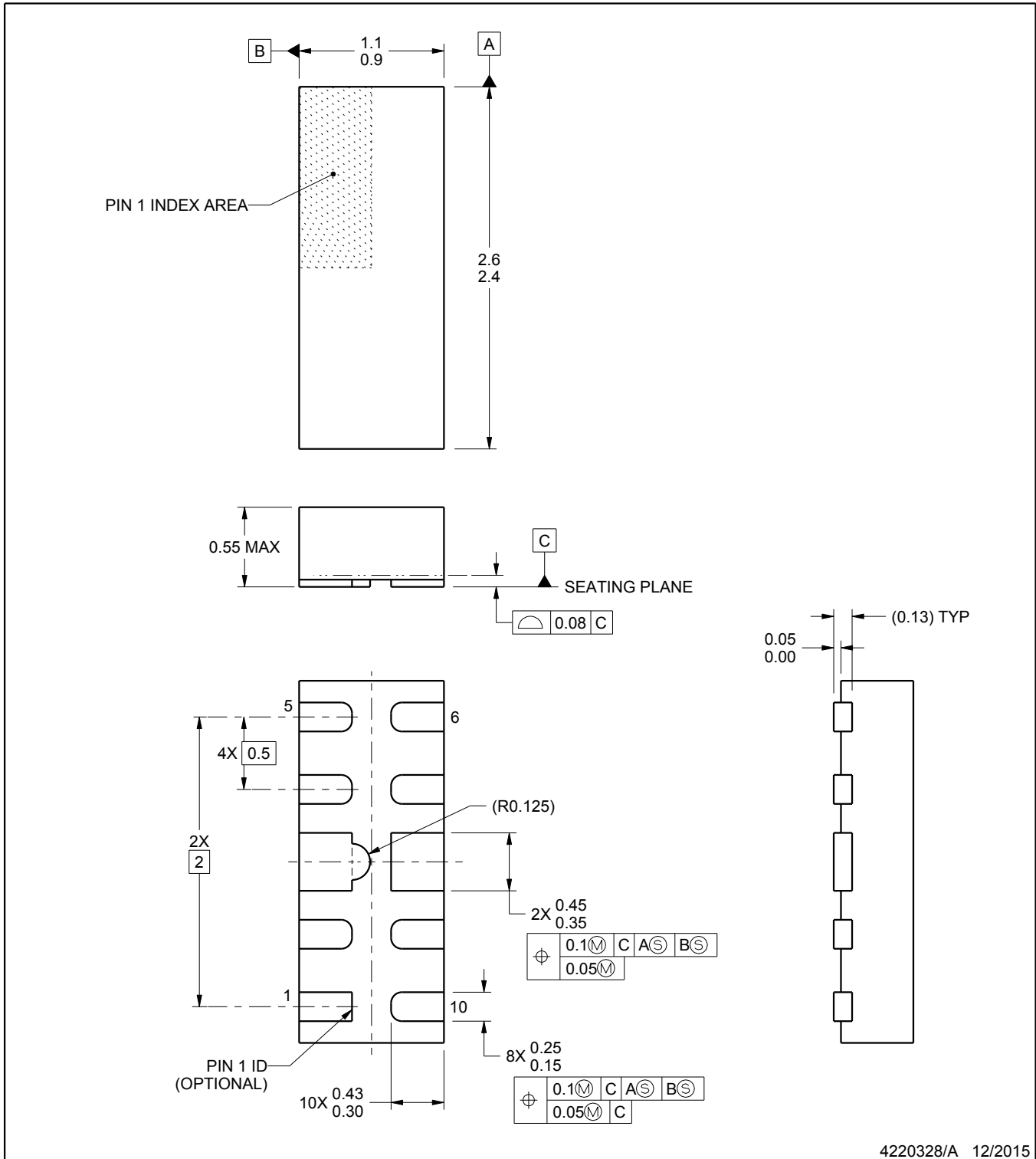

4220328/A 12/2015

**NOTES:**

1. All linear dimensions are in millimeters. Any dimensions in parenthesis are for reference only. Dimensioning and tolerancing per ASME Y14.5M.
2. This drawing is subject to change without notice.

# EXAMPLE BOARD LAYOUT

DQA0010A

USON - 0.55 mm max height

PLASTIC SMALL OUTLINE - NO LEAD

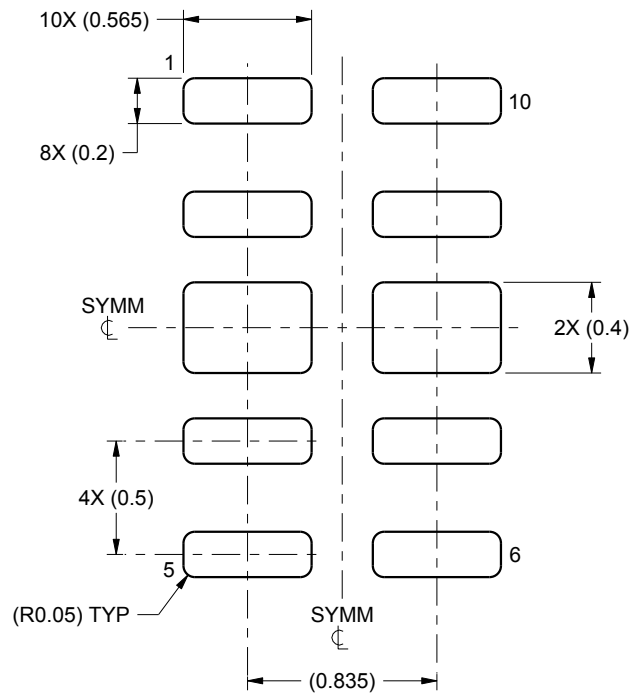

LAND PATTERN EXAMPLE  
SCALE:30X

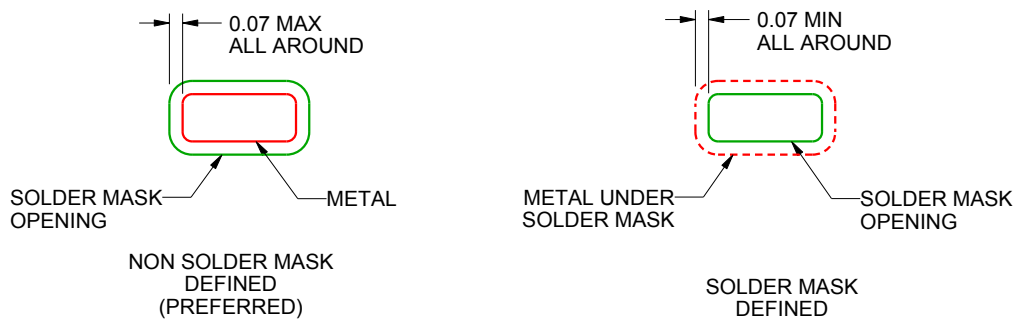

SOLDER MASK DETAILS

4220328/A 12/2015

NOTES: (continued)

3. For more information, see Texas Instruments literature number SLUA271 ([www.ti.com/lit/slua271](http://www.ti.com/lit/slua271)).

# EXAMPLE STENCIL DESIGN

DQA0010A

USON - 0.55 mm max height

PLASTIC SMALL OUTLINE - NO LEAD

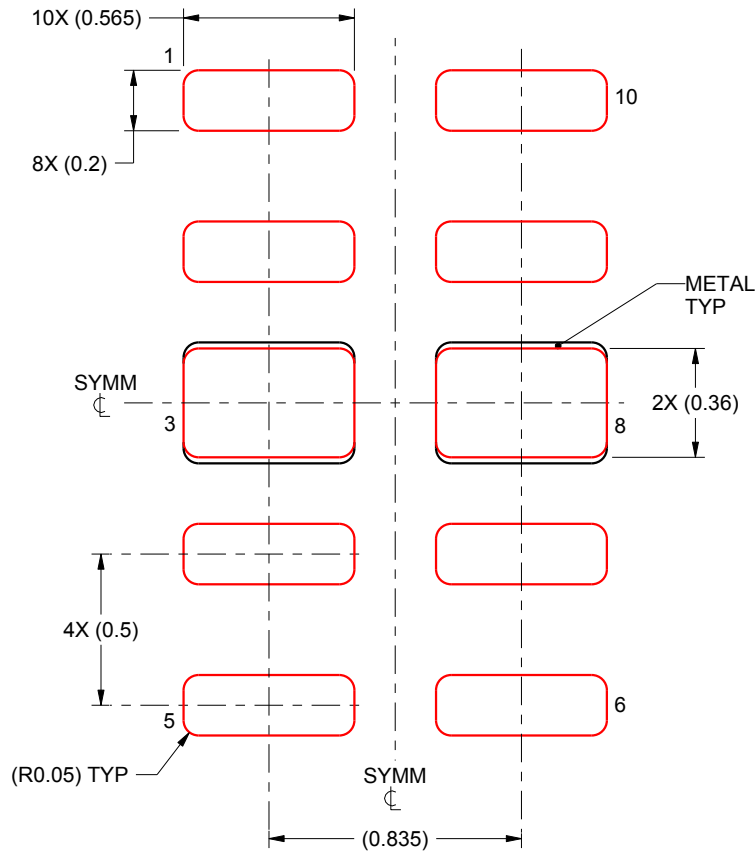

SOLDER PASTE EXAMPLE  
BASED ON 0.1 mm THICK STENCIL

EXPOSED PADS 3 & 8:  
90% PRINTED SOLDER COVERAGE BY AREA UNDER PACKAGE  
SCALE:40X

4220328/A 12/2015

NOTES: (continued)

4. Laser cutting apertures with trapezoidal walls and rounded corners may offer better paste release. IPC-7525 may have alternate design recommendations.

## IMPORTANT NOTICE AND DISCLAIMER

TI PROVIDES TECHNICAL AND RELIABILITY DATA (INCLUDING DATA SHEETS), DESIGN RESOURCES (INCLUDING REFERENCE DESIGNS), APPLICATION OR OTHER DESIGN ADVICE, WEB TOOLS, SAFETY INFORMATION, AND OTHER RESOURCES "AS IS" AND WITH ALL FAULTS, AND DISCLAIMS ALL WARRANTIES, EXPRESS AND IMPLIED, INCLUDING WITHOUT LIMITATION ANY IMPLIED WARRANTIES OF MERCHANTABILITY, FITNESS FOR A PARTICULAR PURPOSE OR NON-INFRINGEMENT OF THIRD PARTY INTELLECTUAL PROPERTY RIGHTS.

These resources are intended for skilled developers designing with TI products. You are solely responsible for (1) selecting the appropriate TI products for your application, (2) designing, validating and testing your application, and (3) ensuring your application meets applicable standards, and any other safety, security, regulatory or other requirements.

These resources are subject to change without notice. TI grants you permission to use these resources only for development of an application that uses the TI products described in the resource. Other reproduction and display of these resources is prohibited. No license is granted to any other TI intellectual property right or to any third party intellectual property right. TI disclaims responsibility for, and you will fully indemnify TI and its representatives against, any claims, damages, costs, losses, and liabilities arising out of your use of these resources.

TI's products are provided subject to [TI's Terms of Sale](#) or other applicable terms available either on [ti.com](http://ti.com) or provided in conjunction with such TI products. TI's provision of these resources does not expand or otherwise alter TI's applicable warranties or warranty disclaimers for TI products.

TI objects to and rejects any additional or different terms you may have proposed.

Mailing Address: Texas Instruments, Post Office Box 655303, Dallas, Texas 75265  
Copyright © 2022, Texas Instruments Incorporated