

This product is completed the Lead-free & RoHS2.0 & Halogen-free.

Customer : Ozdisan

Issued Date	2023-1-30
No.	RD20230130006

SPECIFICATION FOR APPROVAL

No.	(Customer No.)	(Koshin Part No.)	Description	ΦD x L
1		MRS-035V101ME077-T/R	35V100μF	6.3X7.7
2		MRS-016V101ME054-T/R	16V100μF	6.3X5.4



KOSHIN INTERNATONAL LIMITED

Headquarters

Unit 9-10,16/F,New commerce Centre,19 On Sun Street,Siu Lek Yuen,Shatin,N.T.,Hong kong
TEL: (852) 2690 0609 FAX: (852) 2697 9532

Manufacturing Sites

- No.4-6 West Zone,Shangxue Technology Industrial City,Bantian,Longgang,Shenzhen,China
TEL: +86-755-89500370 89500371 FAX: +86-755-89500348
- Koshin Technology Industrial Zone South Huancheng Road,LinWu,Chenzhou,Hunan
Provice,China
TEL: +86-0735-6252288 Postal code:424300

KOSHIN APPROVED SIGNATURE FOR KOSHIN			APPROVED SIGNATURE FOR CUSTOMER
APPROVAL	CHECK	DESIGN	APPROVED BY
			

Please return one copy with your authorized signature when you accept these specifications.

DJS-SD-0013

CONTENTS

NO.	Items
1	Scope
2	Operating Temperature Range
3	Characteristics
4	Frequency Coefficient for Ripple Current
5	Max. Impedance Ratio
6	Characteristics Table
7	Marking
8	Inner conformation drawing and inner constitute parts(curtness drawing)
9	Recommended soldering heat conditions
10	Electrical characteristics
11	Mechanical characteristics
12	Reliability
13	Koshin Part No
14	Product processing diagram
15	Packing
16	Guidelines and Precautions

1. Scope

This specification covers "MRS series" V-Chip Aluminium Electrolytic Capacitors.

2. Operating Temperature Range

Operating temperature range is the range of ambient temperature at which the capacitor can be operated continuously at rated voltage.

3. Characteristics

Unless otherwise specified, the standard range of atmospheric conditions for making measurements and tests are as follows.

Ambient temperature : 15 to 35°C

Air pressure : 86kpa to 106kpa

If there may be doubt on the results, measurements shall be made within the following limits.

Ambient temperature : 20±2°C

Air pressure : 86kpa to 106kpa

4. Frequency Coefficient for Ripple Current

Capacitance(μ F)	Frequency (Hz)			
	120	1K	10K	100K
1.0	1.00	1.50	1.75	1.80
2.2 to 10	1.00	1.30	1.40	1.50
22 to 1,500	1.00	1.05	1.08	1.08

5. Max. Impedance Ratio

Low temperature characteristics	Rated voltage(V)		6.3	10	16	25	35	50	63	100	120Hz	
	Impedance ratio (max)	$Z_{(-25^{\circ}\text{C})} / Z_{(+20^{\circ}\text{C})}$	4	3	2	2	2	2	2	2		2
		$Z_{(-40^{\circ}\text{C})} / Z_{(+20^{\circ}\text{C})}$	10	8	6	4	3	3	3	3		3

6.Characteristics Table

Aluminum Electrolytic Capacitor Specification																						
Series	MRS	35 V 100 μ F		Part No.	MRS-035V101ME077-T/R																	
Customer No.				Case size	Φ D6.3 X L 7.7																	
Specification	Items			Standard																		
	Operating temperature range			- 40 ~ + 85 $^{\circ}$ C																		
	Capacitance tolerance			\pm 20% (20 $^{\circ}$ C ,120Hz)																		
	Dissipation factor (MAX)			小于(Less than) 14% (20 $^{\circ}$ C ,120Hz)																		
	Leakage current (MAX)			小于(Less than) 35 μ A (20 $^{\circ}$ C 35 V 2 min)																		
	ESR (MAX)			/																		
	Ripple current (MAX)			132mA _{rms} (120Hz ,85 $^{\circ}$ C)																		
	Load life			2000 hrs																		
Outline	(Dimensions)																					
	<p>Lead spacing and Diameter Unit: mm</p> <table border="1"> <thead> <tr> <th>D</th> <th>L</th> <th>a</th> <th>A</th> <th>B</th> <th>C</th> <th>W</th> <th>P\pm0.2</th> </tr> </thead> <tbody> <tr> <td>6.3</td> <td>7.7</td> <td>0.5</td> <td>6.6</td> <td>6.6</td> <td>7.2</td> <td>0.5~0.8</td> <td>1.9</td> </tr> </tbody> </table>							D	L	a	A	B	C	W	P \pm 0.2	6.3	7.7	0.5	6.6	6.6	7.2	0.5~0.8
D	L	a	A	B	C	W	P \pm 0.2															
6.3	7.7	0.5	6.6	6.6	7.2	0.5~0.8	1.9															
APPROVAL		CHECK			DESIGN																	

Aluminum Electrolytic Capacitor Specification

Series	MRS	16 V 100 μ F	Part No.	MRS-016V101ME054-T/R
Customer No.			Case size	Φ D6.3 X L 5.4
Specification	Items		Standard	
	Operating temperature range		- 40 ~ + 85 $^{\circ}$ C	
	Capacitance tolerance		\pm 20% (20 $^{\circ}$ C ,120Hz)	
	Dissipation factor (MAX)		小于(Less than) 26% (20 $^{\circ}$ C ,120Hz)	
	Leakage current (MAX)		小于(Less than) 16 μ A (20 $^{\circ}$ C 16 V 2 min)	
	ESR (MAX)		/	
	Ripple current (MAX)		103mArms (120Hz ,85 $^{\circ}$ C)	
	Load life		2000 hrs	

(Dimensions)

Lead spacing and Diameter Unit: mm

D	L	a	A	B	C	W	P \pm 0.2
6.3	5.4	0.5	6.6	6.6	7.2	0.5~0.8	1.9

APPROVAL	CHECK	DESIGN

7. Marking

7.1. Marking on capacitors includes:

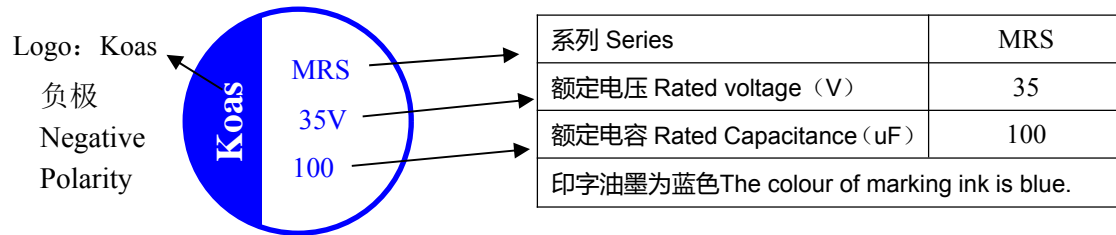

8. Inner conformation drawing and inner constitute parts(curtness drawing)

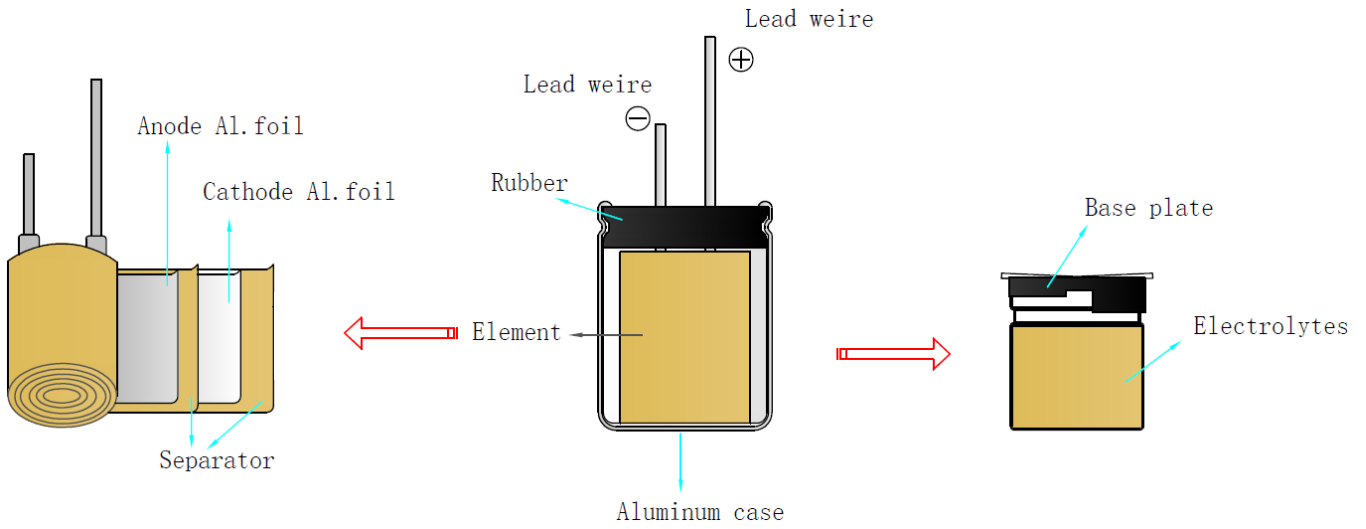

Composing Part	Material
Lead Wire	Fe+Al+Cu+Sn
Case	Aluminum
Base Plate	PPA
Paper	Cellulose
Anode Foil	Aluminum Foil
Cathode Foil	Aluminum Foil
Electrolyte	GBL
Seal	Rubber

9.Recommended soldering heat conditions:

RECOMMEDEDSOLDERINGCONDITIONSFORALUMINIUM SURFACE MOUNT TYPE

-Air or Infrared reflow soldering

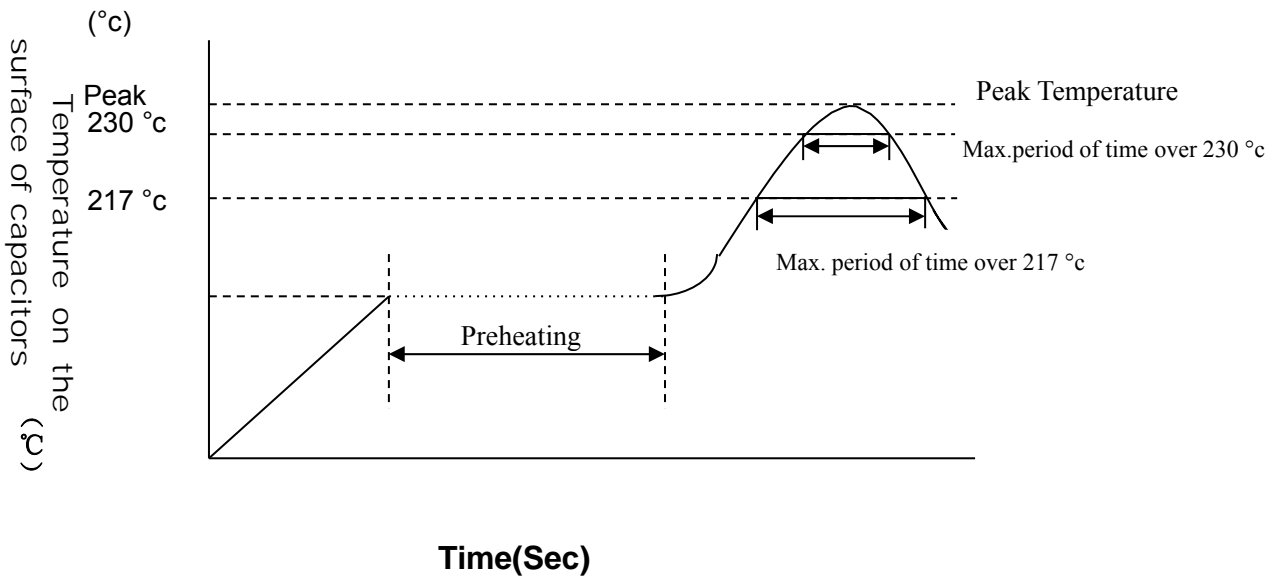

SMDshape	size	voltage	preheating	Time maintained over 217 °c	Time maintained over 230 °c	Peak temperature	Reflow number
	B52~E87	4~63V	150 - 180C ≤120Sec.	≤90 Sec	≤60 Sec	≤260 °c	≤2 times
		63V,80V		≤60 Sec	≤40 Sec	≤250 °c	≤2 times
	F63~G100	4~50V		≤60 Sec	≤30 Sec	≤245 °c	≤2 times
		63V~100, 400V		≤30 Sec	≤20 Sec	≤240 °c	≤2 times
	H135~K215	6.3~50V		≤30 Sec	≤20 Sec	≤240 °c	≤2 times
		63~450V		≤20 Sec	-	≤230 °c	≤2 times

Remark: Reflow number cannot over 2 times. After first time reflow , must be ensure that the temperature of capacitors became cold to room temperature(5~35°C) ,then continue second flow.

NO.	ITEM	TEST METHOD	SPECIFICATION																				
10.6	Surge test	<p>Rated surge voltage shall be applied (switch on)for 30±5 second and then shall be applied (switch off) with discharge for 5.5min at room temperature. This cycle shall be repeated for 1000 cycles. Duration of one cycle is 6±0.5 minutes</p> <p>Surge voltage</p> <table border="1"> <tr> <td>Working voltage(V) 工作电压(V)</td> <td>6.3</td> <td>10</td> <td>16</td> <td>25</td> <td>35</td> <td>50</td> <td>63</td> <td>80</td> <td>100</td> </tr> <tr> <td>Surge voltage (V) 浪涌电压(V)</td> <td>8</td> <td>13</td> <td>20</td> <td>32</td> <td>44</td> <td>63</td> <td>79</td> <td>100</td> <td>125</td> </tr> </table>	Working voltage(V) 工作电压(V)	6.3	10	16	25	35	50	63	80	100	Surge voltage (V) 浪涌电压(V)	8	13	20	32	44	63	79	100	125	<p>Capacitance change: within±15% of the initial specified value.</p> <p>Dissipation factor: Less than specified value.</p> <p>Leakage current: Within initial specified value.</p>
Working voltage(V) 工作电压(V)	6.3	10	16	25	35	50	63	80	100														
Surge voltage (V) 浪涌电压(V)	8	13	20	32	44	63	79	100	125														

11.Mechanical characteristics :

NO.	ITEM	TEST METHOD	SPECIFICATION																
11.1	Lead strength	<p>(A)Tensile strength: wire lead terminal:</p> <table border="1"> <tr> <td>d(mm)</td> <td>≤0.5</td> <td>0.5<d≤0.8</td> <td>0.8<d≤1.25</td> </tr> <tr> <td>load(kg)</td> <td>0.5</td> <td>1.0</td> <td>2.0</td> </tr> </table> <p>The capacitor shall withstand the constant tensile force specified between the body and each lead for 10seconds without damage either mechanical or electrical.</p> <p>(B) Bending strength: wire lead terminal:</p> <table border="1"> <tr> <td>d(mm)</td> <td>≤0.5</td> <td>0.5<d≤0.8</td> <td>0.8<d≤1.25</td> </tr> <tr> <td>load(kg)</td> <td>0.5</td> <td>0.5</td> <td>1.0</td> </tr> </table> <p>with the capacitor in a vertical position apply the load specified axially to each lead. The capacitor shall be rotated slowly from the vertical to the horizontal position, back to the vertical position. The 90° in the opposite direction and back the original position. Performance of capacitor shall not have change and leads shall be undamaged.</p>	d(mm)	≤0.5	0.5<d≤0.8	0.8<d≤1.25	load(kg)	0.5	1.0	2.0	d(mm)	≤0.5	0.5<d≤0.8	0.8<d≤1.25	load(kg)	0.5	0.5	1.0	<p>When the capacitance is measured, there shall be no intermittent contacts, or open-or short-circuiting.</p> <p>There shall be no such mechanical damage as terminal damage etc.</p>
d(mm)	≤0.5	0.5<d≤0.8	0.8<d≤1.25																
load(kg)	0.5	1.0	2.0																
d(mm)	≤0.5	0.5<d≤0.8	0.8<d≤1.25																
load(kg)	0.5	0.5	1.0																

NO.	ITEM	TEST METHOD	SPECIFICATION
11.2	Vibration resistance	The frequency of the vibration shall vary uniformly within the range 10 to 55 Hz with the amplitude of 0.75mm, completing the cycle in the interval of one minute. The capacitor shall be securely mounted by its leads with hold the body of capacitor. The capacitor shall be vibrated in three mutually perpendicular directions for a period of 2 hours in each direction.	Capacitance: no unsteady. Appearance: no abnormal. Capacitance change: within $\pm 5\%$ of initial measured value.
11.3	Solder-ability	The leads are dipped in the solder bath of Sn at $245^{\circ}\text{C}\pm 5^{\circ}\text{C}$ for 2 ± 0.5 seconds. The dipping depth should be set at 1.5~2.0 mm.	The solder alloy shall cover the 95% or more of dipped lead's area.

12. Reliability :

NO.	ITEM	TEST METHOD	SPECIFICATION
12.1	Soldering heat resistance	The leads immerse in the solder bath of Sn at $260^{\circ}\text{C}\pm 5^{\circ}\text{C}$ for 10 ± 1 seconds until a distance of 1.5~2.0mm from the case.	No visible damage or leakage of electrolyte. Capacitance change: Within $\pm 5\%$ of the initial measured value Tan δ : Less than specified value. Leakage current: Less than specified value
12.2	Moisture Resistance	Subject the capacitor to $40^{\circ}\text{C} \pm 2^{\circ}\text{C}$ and 90% to 95% relative humidity for 504 hours.	Capacitance change: Within $\pm 20\%$ of the initial measured value Tan δ : Less than 1.2 specified value. Leakage current: Less than specified value

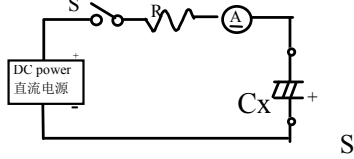
NO.	ITEM	TEST METHOD	SPECIFICATION
12.3	Load life	After 2000 hours continuous application of DC rated working voltage and rated ripple current at $85\text{ }^{\circ}\text{C} \pm 2\text{ }^{\circ}\text{C}$, Measurements shall be performed after 16 hours exposed at room temperature.	Capacitance change: within $\pm 25\%$ of the initial specified value. Dissipation factor: Less than 300% of the initial specified value.
12.4	Shelf life	After storage for 1000 hours at $85\text{ }^{\circ}\text{C} \pm 2\text{ }^{\circ}\text{C}$ without voltage application, Measurements shall be performed after exposed for 16 hrs at room temperature after application of Testing	Leakage current: Within initial specified value.
12.5	Storage at low temperature	The capacitor shall be stored at temperature of $-40\text{ }^{\circ}\text{C} \pm 3\text{ }^{\circ}\text{C}$ for 16 hours, during which time be subjected to standard atmospheric conditions for 16 hours or more. After which measurements shall be made.	Capacitance change: Within $\pm 10\%$ of the initial value. Tan δ : less than specified value Leakage current: Less than specified value. Appearance :no Abnormal.
12.6	Pressure relief	DC test Send the following electricity while applying the inverse voltage. Where case size $D \leq 22.4\text{mm}$: 1 A d.c.max $D > 22.4\text{mm}$: 10 A d.c.max Note: 1.This requirement applies to capacitors with a diameter of 6 mm or more. 2. When the pressure relief device does not open even 30 minutes after commencement of test, the test may be ended.	DC test circuit  : Switch Ⓐ: DC current meter Cx: testing capacitor The pressure relief device shall open in such a way as to avoid any damage of fire or explosion of capacitor elements (terminal and metal foil etc.) or cover.

13.Koshin Part No

Part Number System

MRS-035V 101 M E 077 - T/R

① ② ③ ④ ⑤ ⑥ ⑦

(1) Series

MRS	MRW	MRH	MRL	MRB	MRN	MRE	MRA	MRF	MRT
-----	-----	-----	-----	-----	-----	-----	-----	-----	-----

(2) Voltage(WV)

Voltage(WV)	4	6.3	10	16	25	35	50	63	80	100	110	115
Code	004	6R3	010	016	025	035	050	063	080	100	110	115

Voltage(WV)	125	160	165	200	220	250	330	350	400	450	500	550
Code	125	160	165	200	220	250	330	350	400	450	500	550

(3) Capacitance

Capacitance is show in microfarads (μF)

μF	0.1	0.47	1	2.2	22	220	2200	22000
Code	0R1	R47	010	2R2	220	221	222	223

(4) Capacitance tolerance

Tolerance %	± 5	± 10	± 15	± 20	-0 to +100	-0 to +20	-10 to +20	-10 to +100
Code	J	K	L	M	P	R	V	W

Tolerance %	-15 to +20	-20 to +40	-20 to +80	-20 to +5	+5 to +20	-10 to +5	-30 to +20	-15 to +5
Code	N	X	E	A	B	C	D	F

(5) Case (D: mm)

Diameter	4	5	6.3	8	10	12.5	16	18
Code	B	C	E	F	G	H	J	K

(6) Case (L: mm)

Description	5	7	11	12.5	25	35.5	40	100	110	111	120	130	140	150	220	250
Code	050	070	110	125	250	355	400	A00	A10	A11	A20	A30	A40	A50	B20	B50

(7) Lead treatment

Description	Reel Packing
Code	T/R

14. Product processing diagram:

14.1. Product size drawing:

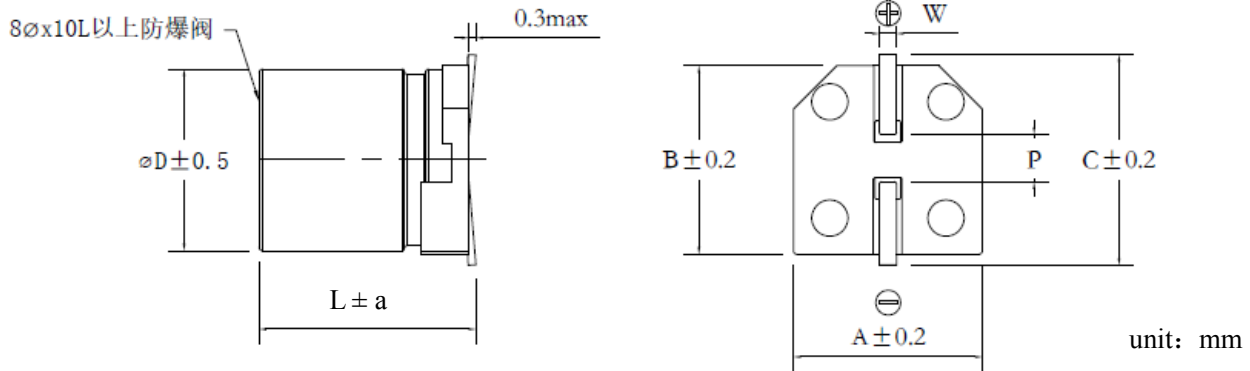

ΦD	L	a	A	B	C	W	P ± 0.2
5	5.7	0.5	5.3	5.3	5.9	0.5~0.8	1.4
6.3	5.4/5.7	0.5	6.6	6.6	7.2	0.5~0.8	1.9
6.3	7.7	0.5	6.6	6.6	7.2	0.5~0.8	1.9
8	7	0.5	8.3	8.3	9.0	0.7~1.1	3.1
8	10.5	0.5	8.3	8.3	9.0	0.7~1.1	3.1
10	10.5	0.5	10.3	10.3	11.0	0.7~1.1	4.7
12.5	13.5	1.0	13.0	13.0	13.7	1.0~1.3	4.2
12.5	16.5	1.0	13.0	13.0	13.7	1.0~1.3	4.2
16	16.5	1.0	17.0	17.0	18.0	1.0~1.3	6.5
16	21.5	1.0	17.0	17.0	18.0	1.0~1.3	6.5
18	16.5	1.0	19.0	19.0	20.0	1.0-1.3	6.5
18	21.5	1.0	19.0	19.0	20.0	1.0-1.3	6.5

14.2 Land/Pad Pattern

unit: mm

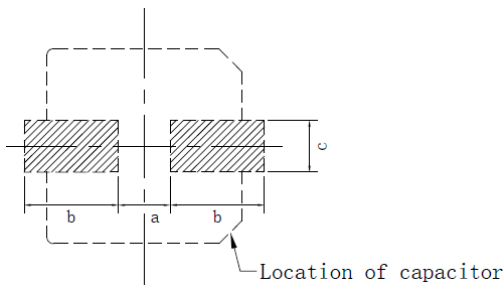

: Solder land on PC board

Size	a	b	c
C052,C057	1.4	3.0	1.6
E052,E057,E077	1.9	3.5	1.6
F063	2.3	4.5	1.6
F100	3.1	4.2	2.2
G100	4.5	4.4	2.2
H135,H160	4.0	5.7	2.5
J165,J215	6.0	6.9	2.5
K165,K215	6.0	7.9	2.5

15.Packing

15.1 Taping Specification for SMD Type

15.1.1 Carrier Tape

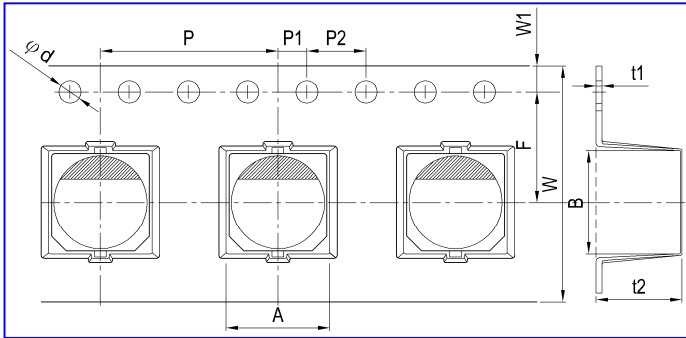

Fig. 1-1

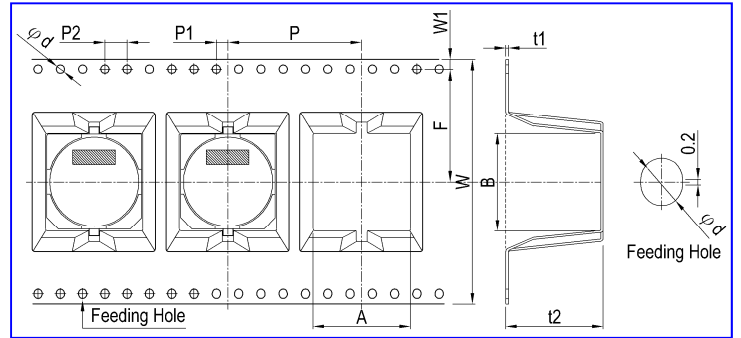
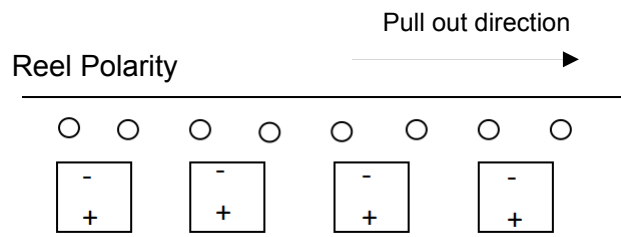
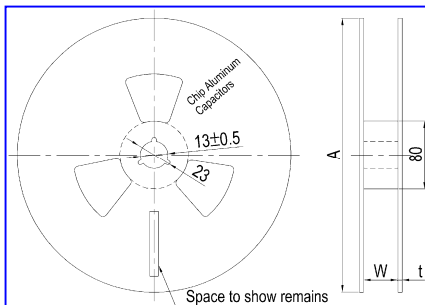

Fig. 1-2

Unit: mm

φDXL	A	B	φd	F	P	P1	P2	t1	t2	W	W1	Fig.No.
	±0.2	±0.2	±0.1	±0.1	±0.1	±0.1	±0.1	max	±0.2	±0.3	±0.15	
5X5.7	5.7	5.7	1.5	5.5	12	2.0	4.0	0.6	6.3	12	1.75	1-1
6.3X5.4/5.7	7.0	7.0	1.5	7.5	12	2.0	4.0	0.6	6.3	16	1.75	1-1
6.3X7.7	7.0	7.0	1.5	7.5	12	2.0	4.0	0.6	8.3	16	1.75	1-1
8X7	8.7	8.7	1.5	11.5	16	2.0	4.0	0.6	8.8	24	1.75	1-1
8X10.5	8.7	8.7	1.5	11.5	16	2.0	4.0	0.6	11.0	24	1.75	1-1
10X10.5	10.7	10.7	1.5	11.5	16	2.0	4.0	0.6	11.0	24	1.75	1-1
12.5X13.5	13.4	13.4	1.5	14.2	24	2.0	4.0	0.6	15	32	1.75	1-2
12.5X16.5	13.4	13.4	1.5	14.2	24	2.0	4.0	0.6	17.5	32	1.75	1-2
16X16.5	17.5	17.5	1.5	20.2	28	2.0	4.0	0.5	17.5	44	1.75	1-2
16X21.5	17.5	17.5	1.5	20.2	28	2.0	4.0	0.5	22.5	44	1.75	1-2
18X16.5	19.5	19.5	1.5	20.2	32	2.0	4.0	0.5	17.5	44	1.75	1-2
18X21.5	19.5	19.5	1.5	20.2	32	2.0	4.0	0.5	22.5	44	1.75	1-2

15.1.2 Reel Package



Case size	Φ5	Φ6.3	Φ8x7	Φ8x8~12.5	Φ10	Φ12.5	Φ16~18
W	14	18	18	26	26	34	46
A	380	380	380	380	380	380	380
t	3.0	3.0	3.0	3.0	3.0	3.0	3.0

15.1.3 Packing specification

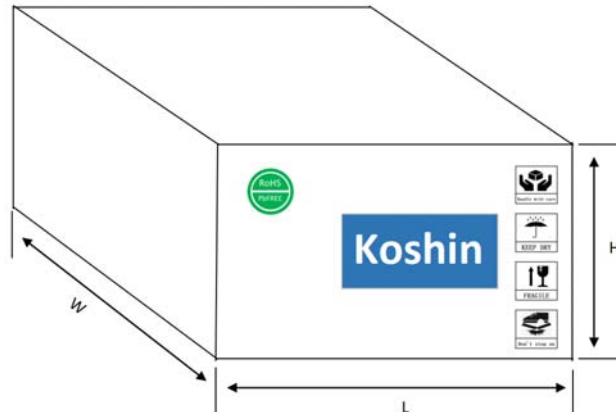

Product size	Carton size ± 2 (mm)			Q'ty / Reel	Q'ty / Box
	L	W	H		
5X5.2~7	410	410	285	1000	12000
6.3X5.2~7.7	410	410	285	1000	10000
6.3X11	410	410	285	500	5000
8X6.5~11	410	410	285	500	4000
8X12	410	410	285	400	3200
10X8~10.5	410	410	285	500	4000
10X13.5	410	410	285	400	3200
12.5X13.5	410	410	285	200	1200
18X16.5	410	410	285	125	500

15.1.4 Label:

Series	Size(mm)	Sample
Label	90×40	As the right

Koshin Electrolytic Capacitors	
OPN:	× × × ×
Type: ③	Qty: ⑨ pcs
CPN: ④	Work order number: ②
①	



① Customer name

⑥ Voltage

⑩ Work order number

⑦ Capacity

③ Koshin Part No.

⑧ Size

④ Customer Part No.

⑨ Quantity

⑤ Series

15.1.5 Sealing Tape Reel Strength

15.1.5.1 Peel angle: 165 to 180°C referred to the surface on which the tape is glued

15.1.5.2 Peel speed: 300mm per minutes

15.1.5.3 The peel strength must be 0.1 ~ 0.7N under these conditions.

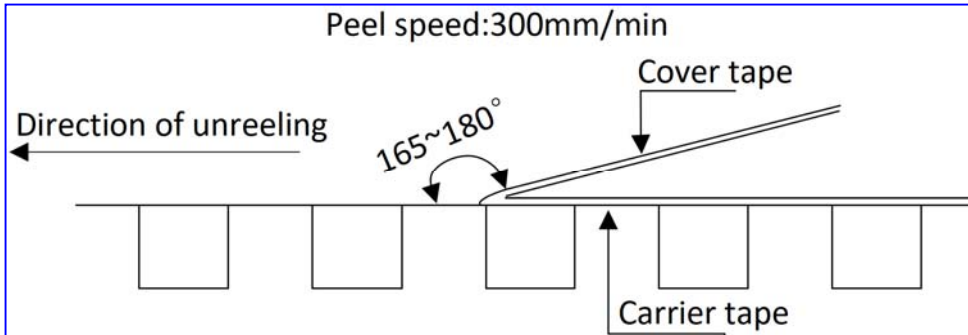

15.1.6 Taping method and polarity

15.1.6.1 5、6、8 phi

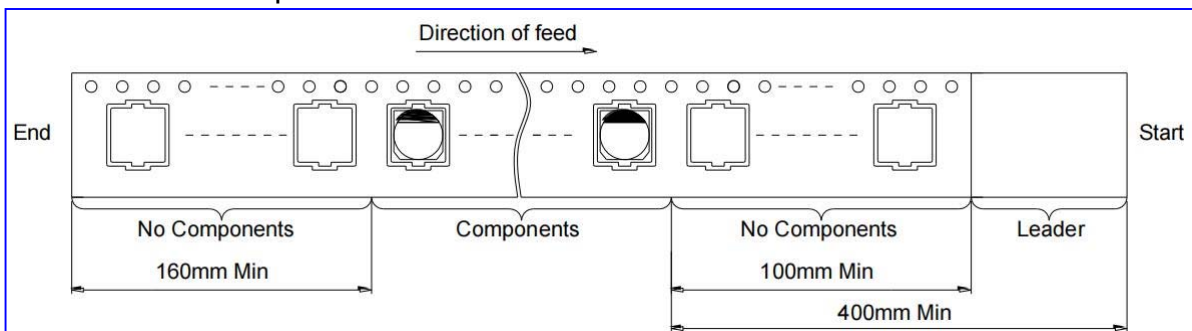

15.1.6.2 10 phi

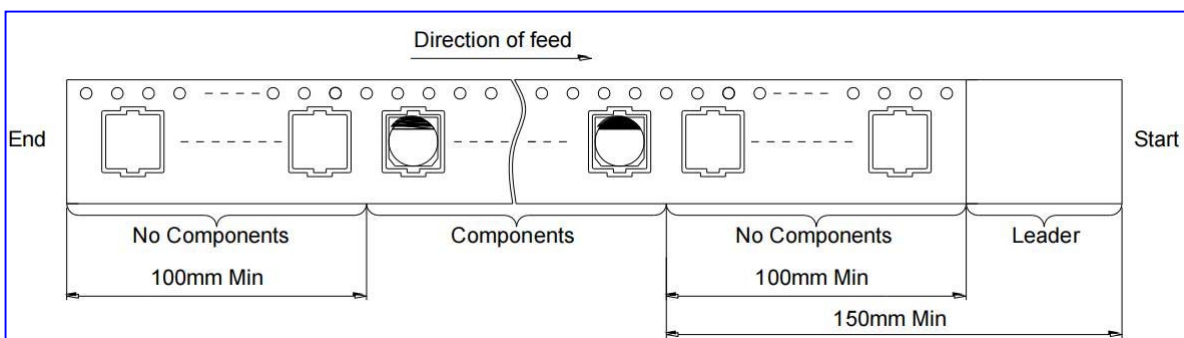

Cautions for Using Aluminum Electrolytic Capacitors

1. When reverse voltage is applied on DC aluminum electrolytic capacitor, the circuit will be short out and the capacitor will be damaged due to abnormal current flows through the capacitor. Please use non-polar types of capacitors when the positive voltage is applied on the cathode terminal.
2. When capacitor is used at higher voltage than the rated voltage, leakage current increased, characteristics drastically deteriorated and damaged in a short period may occur as a result. Please take extra caution that the peak voltage should not exceed the rated voltage.
3. Sudden charge and discharge
When aluminum electrolytic capacitors for general purpose-use are employed in rapid charge and discharge application, its life expectancy may be shortened resulted from capacitance decrease, heat rise, etc.
4. Storage of the capacitor
 - ① We recommend the following conditions for storage:
Ambient temperature: 5~35°C, Ambient humidity: <75%RH;
 - a) Storage life: ≤ 12 months;
 - b) **If storage life >12 months, the products need to be charged again before using;**
 - c) If Storage time >three years, the products need to be discarded;
 - d) Expiry Date: calculating from the date marked on the sleeve;
 - e) Please keep capacitors in the original package;
 - f) Avoid storing the capacitors under such circumstances:
 - ※ With water and oil or damp & dewing location.
 - ※ With gas and oil.
 - ※ With toxic gases such as hydrogen sulfide, sulfurous acid, nitrous acid, chlorine, bromine and methane.
 - ※ With direct sunlight, Ozone, ultraviolet rays or radiation.
5. If excessive ripple current is applied on the capacitor, excessive heat will be generated inside, the capacitance will be reduced and capacitor's life shall be shortened. Rated voltage has been marked on the capacitor; therefore, the peak value of the ripple voltage should be less than the rated voltage.
6. Ambient temperature
Life of aluminum electrolytic capacitor is affected by the ambient temperature. It is generally known that the life doubles for each 10°C decrease in temperature.
7. Tensile strength of lead wire
When a strong force is applied to the lead wires or terminals, stress is put on the internal connections, which may result in short circuit, open circuit or increased leakage current. So it is not advisable to bend or handle a capacitor after it has been soldered to the PC board.
8. Heat resistance at the soldering process
During soldering process, secondary shrinkage or sleeve crack may occur when soldering temperature is too high or soldering time is too long.

9. Hole pitch and position of PC board

When designig a PC board , its hole pitch should be designed to coincide with the lead pitch(lead spacing) of the capacitor specified in the catalog or specifications.When a capacitor is forcibly inserted into an unmatched hole pitch,a force will put on the leads and which could result in a short circuit or increased leakage current.

10. Cleaning after soldering

① The aluminum electrolyte capacitors should be fee halogenated solvents during board cleaning after soldering. Use solvent proof capacitors when halogenated solvents are used.

② After cleaned with the solvent which should proof the quality of capacitors, the capacitors should not be kept in solvent environments of non-ventilated places. Let the capacitors after cleaning dry with hot blast fully above 10mins and the temperature of hot blast should not be over than specified upper limit of capacitors.

11. Adhesives、 fixative and coating materials(coating agent)

① Do not use halogenated adhesives and coating materials to fix aluminum electrolytic capacitors.

②Do not cover up all the sealing area of capacitors with adhesives 、 fixative or coating materials(coating agent), make coverage only partial

12. Certificates

- ① ISO 9001:2008 Certificate
- ② ISO 14001:2004 Certificate
- ③ISO/TS 16949:2009 Certificate
- ④OHSAS 18001:2007 Certificate

※ 符合 RoHS2.0 RoHS compliance

Accord with the latest standard of RoHS2.0 , if customers have any special requirments, according to the relevant agreements which signed by both parts.