

HF158F

MINIATURE HIGH POWER RELAY



File No.:E134517



File No.:40032833



File No.:CQC17002176312

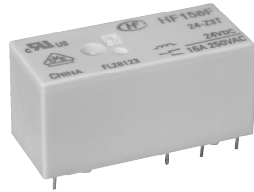

Features

- 20A switching capability
- Low height: 15.7 mm
- 5kV dielectric strength (between coil and contacts)
- Creepage distance: 10mm, meet reinforce insulation
- UL insulation system: Class F
- Product in accordance to IEC 60335-1 available
- Sockets available
- Plastic sealed and flux proofed types available

RoHS compliant

CONTACT DATA

Contact arrangement	1A, 1C
Contact resistance ¹⁾	100mΩ max.(at 1A 6VDC)
Contact material	AgNi, AgSnO ₂
Contact rating	16A 250VAC
Max. switching voltage	440VAC
Max. switching current	20A
Max. switching power	5000VA
Mechanical endurance	2 x 10 ⁷ OPS
Electrical endurance	H33 type: 1 x 10 ⁵ OPS (16A 277VAC, Resistive load, Room temp., 1s on 9s off) H3T type: 1 x 10 ⁵ OPS (16A 277VAC, Resistive load, Room temp., 1s on 9s off)

Notes: 1) The data shown above are initial values.

CHARACTERISTICS

Insulation resistance	1000MΩ (at 500VDC)	
Dielectric strength	Between coil & contacts	5000VAC 1min
	Between open contacts	1000VAC 1min
Surge voltage (between coil & contacts)	10kV (1.2 / 50μs)	
Operate time (at rated. volt.)	15ms max.	
Release time (at rated. volt.)	8ms max.	
Temperature rise (at rated. volt.)	60K max.	
Shock resistance *	Functional	98m/s ²
	Destructive	980m/s ²
Vibration resistance *	10Hz to 150Hz 10g/5g	
Humidity	5% to 85% RH	
Ambient temperature	-40°C to 85°C	
Termination	PCB	
Unit weight	Approx. 11.5g	
Construction	Plastic sealed, Flux proofed	

Notes: 1) The data shown above are initial values.

2) * Index is not that of relay length direction.

COIL

Coil power	Approx. 400mW
------------	---------------

COIL DATA

at 23°C

Nominal Voltage VDC	Pick-up Voltage VDC max. ¹⁾	Drop-out Voltage VDC min. ¹⁾	Max. Voltage VDC ²⁾	Coil Resistance Ω
5	3.50	0.5	9.0	62 x (1±10%)
6	4.20	0.6	10.8	90 x (1±10%)
9	6.30	0.9	16.2	202 x (1±10%)
12	8.40	1.2	21.6	360 x (1±10%)
18	12.6	1.8	32.4	810 x (1±10%)
24	16.8	2.4	43.2	1440 x (1±10%)
48 ³⁾	33.6	4.8	86.4	5760 x (1±15%)

Notes: 1) The data shown above are initial values.

2) Maximum voltage refers to the maximum voltage which relay coil could endure in a short period of time.

3) For products with rated voltage ≥ 48V, measures should be taken to prevent coil overvoltage in order to protect coil in test and application (eg. Connect diodes in parallel).

SAFETY APPROVAL RATINGS

UL/CUL	AgNi	16A 277VAC 16A 24VDC 10A 400VAC at 85°C 10A 250VAC at 105°C 20A 250VAC at 85°C
	AgSnO ₂	1HP 240VAC B300/R300 at 85°C TV-5 120VAC 16A 277VAC 16A 24VDC 10A 400VAC at 85°C 10A 250VAC at 105°C 20A 250VAC at 85°C
VDE	AgNi	13A 250VAC at 70°C 16A 250VAC at 85°C NO: 10A 250VAC at 25°C / at 105°C (Only for (217) type)
	AgSnO ₂	16A 250VAC at 85°C 8A 250VAC cosφ=0.4 at 85°C
UL/CUL (HF158F-T)		16A 277VAC at 105°C
VDE (HF158F-T)		NO: 20A 250VAC at Room temp. / 105°C NO: 16A 250VAC at Room temp. / 105°C

Notes: 1) All values unspecified are at room temperature.

2) Only typical loads are listed above. Other load specifications can be available upon request.



HONGFA RELAY

ISO9001, ISO/TS16949, ISO14001, OHSAS18001, IECQ QC 080000 CERTIFIED

2019 Rev. 1.00

ORDERING INFORMATION

Type	HF158F /	12	-Z	S	3	3	(XXX)
	HF158F: Standard HF158F-T: High temperature						
Coil voltage	5, 6, 9, 12, 18, 24, 48VDC						
Contact arrangement	H: 1 Form A		Z: 1 Form C				
Construction ^{1) 2)}	S: Plastic sealed		Nil: Flux proofed				
Version	3: 5.0mm						
Contact material	3: AgNi		T: AgSnO ₂				
Special code ³⁾	XXX: Customer special requirement			Nil: Standard			

- Notes:** 1) We recommend flux proofed types for a clean environment (free from contaminations like H₂S, SO₂, NO₂, dust, etc.). We suggest to choose plastic sealed types and validate it in real application for an unclean environment (with contaminations like H₂S, SO₂, NO₂, dust, etc).
- 2) Contact is recommended for suitable condition and specifications if water cleaning or surface process is involved in assembling relays on PCB.
- 3) The customer special requirement express as special code after evaluating by Hongfa. e.g. (217) stands for product with the electrical endurance of 3×10^5 OPS at 10A load.

OUTLINE DIMENSIONS, WIRING DIAGRAM AND PC BOARD LAYOUT

Unit: mm

Outline Dimensions

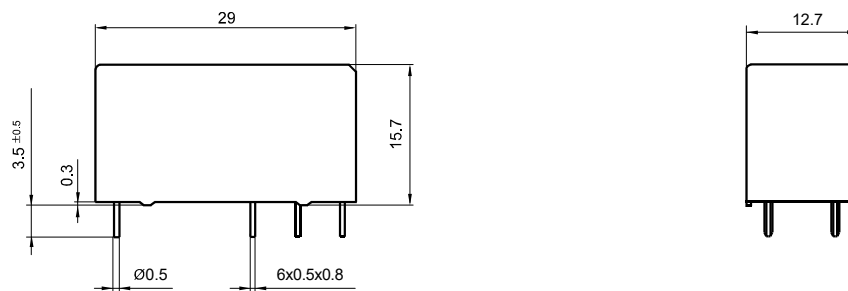

PCB Layout (Bottom view)

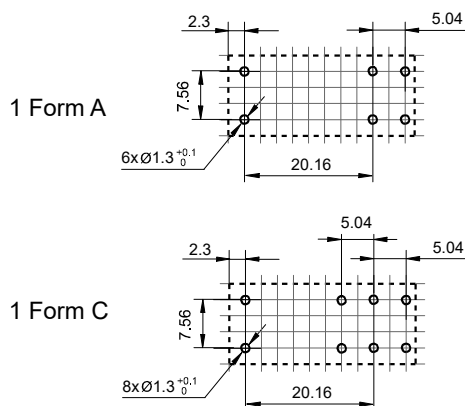

Wiring Diagram (Bottom view)

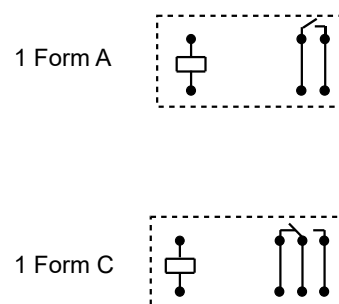

- Remark:** 1) In case of no tolerance shown in outline dimension: outline dimension ≤ 1 mm, tolerance should be ± 0.2 mm; outline dimension > 1 mm and ≤ 5 mm, tolerance should be ± 0.3 mm; outline dimension > 5 mm, tolerance should be ± 0.4 mm.
- 2) The tolerance without indicating for PCB layout is always ± 0.1 mm.
- 3) The width of the gridding is 2.52mm.

CHARACTERISTIC CURVES

MAXIMUM SWITCHING POWER

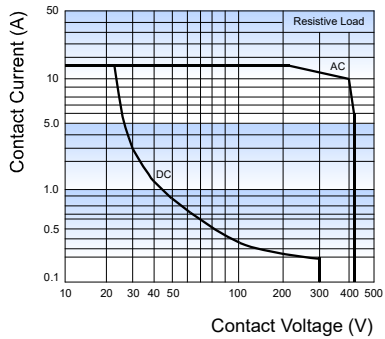

ENDURANCE CURVE

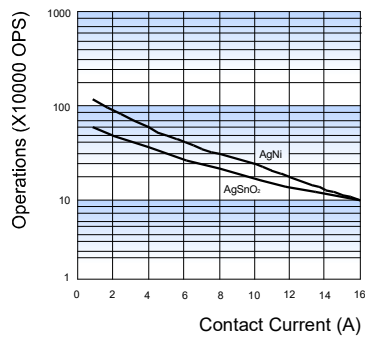

COIL OPERATING RANGE (DC) *

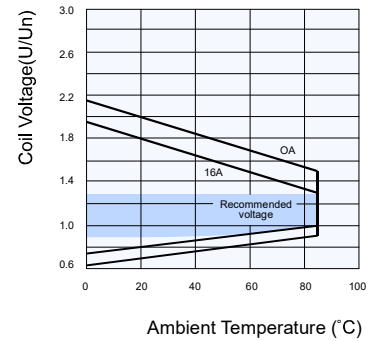

Test conditions:

NO, 250VAC, Resistive load,
Flux proofed, Room temp., 1s on 9s off.

Notes: * The use of a relay with an energising voltage

other than the rated coil voltage may lead to reduced electrical life.

An energising voltage over the above range may damage the insulation of relay coil.

Disclaimer

The specification is for reference only. See to "Terminology and Guidelines" for more information. Specifications subject to change without notice. We could not evaluate all the performance and all the parameters for every possible application. Thus the user should be in a right position to choose the suitable product for their own application. If there is any query, please contact Hongfa for the technical service. However, it is the user's responsibility to determine which product should be used only.

© Xiamen Hongfa Electroacoustic Co., Ltd. All rights of Hongfa are reserved.