



### 1 Form A 5A slim power relay for interface

## PA RELAYS



RoHS compliant

Protective construction: Sealed type

### FEATURES

**1. Slim size (width 5 mm .197 inch, height 12.5 mm .492 inch) permits higher density mounting**

Despite the slim 5 mm .197 inch width, the 20 mm .787 inch length is still compact and the 12.5 mm profile is low. Even when a socket is used, the height is still only 18 mm .709 inch. Suitable for high-density mounting, these relays enable device size smaller.

**2. Nominal operating power: High sensitivity of 120mW**

Enables smaller power supplies, facilitates energy saving applications, and contributes to device size smaller.

**3. Control from low level loads to 5 A**

Use of gold-clad twin contacts enables control of low level loads down to 100 mV 100  $\mu$ A and up to 5 A 250 V AC and 30 V DC.

**4. Reinforced according to IEC1131-2 (TÜV)**

**5. High surge breakdown voltage (4000 V) and high breakdown voltage (2000 V)**

Between contacts and coil of 2,000 V and surge resistance of 4,000 V work to prevent controller malfunctions caused by noise and surges.

**6. Outstanding vibration and shock resistance**

Functional shock resistance: 147 m/s<sup>2</sup>

Functional vibration resistance:

10 to 55 Hz (at double amplitude of 2.5 mm .098 inch)

Keeps equipment from miss-operation due to vibration and shock.

Can be used as mounted on control panel doors.

**7. Sealed construction allows automatic washing**

**8. SIL (single in line) terminal layout**

**9. Complies with safety standards**

Complies with Japanese Electrical Appliance and Material Safety Law, and certified by UL, CSA, and TÜV.

**10. Sockets are available**

### TYPICAL APPLICATIONS

**1. Industrial equipment, office equipment**

**2. Measuring devices and test equipment**

**3. Interface relays for programmable controllers**

**4. Output relays in small devices such as timers, counters, sensors, and temperature controllers**

### ORDERING INFORMATION

PA 1a -

Contact arrangement

1a: 1 Form A (Bifurcated)

Nominal coil voltage (DC)

5, 6, 9, 12, 18, 24V

Note: Certified by UL, CSA and TÜV

### TYPES

Contact arrangement	Nominal coil voltage	Part No.
1 Form A	5V DC	PA1a-5V
	6V DC	PA1a-6V
	9V DC	PA1a-9V
	12V DC	PA1a-12V
	18V DC	PA1a-18V
	24V DC	PA1a-24V

Standard packing: Tube: 25 pcs.; Case: 1,000 pcs.

\* Terminal sockets available.

# RATING

## 1. Coil data

Nominal coil voltage	Pick-up voltage (at 20°C 68°F)	Drop-out voltage (at 20°C 68°F)	Nominal operating current [±10%] (at 20°C 68°F)	Coil resistance [±10%] (at 20°C 68°F)	Nominal operating power	Max. applied voltage (at 20°C 68°F)
5V DC	70%V or less of nominal voltage *1 (Initial)	5%V or more of nominal voltage*1 (Initial)	24mA	208Ω	120mW	120%V of nominal voltage
6V DC			20mA	300Ω		
9V DC			13.3mA	675Ω		
12V DC			10mA	1,200Ω		
18V DC			6.7mA	2,700Ω		
24V DC			7.5mA	3,200Ω	180mW*2	

Notes: \*1 Pulse drive (JIS C 5442)

\*2 24V DC, 120mW type are also available, please consult us.

## 2. Specifications

Characteristics	Item	Specifications	
Contact	Arrangement	1 Form A (Bifurcated)	
	Contact resistance (Initial)	Max. 30 mΩ (By voltage drop 6 V DC 1A)	
	Contact material	Au-clad AgNi type	
Rating	Nominal switching capacity (resistive load)	5 A 250 V AC, 5 A 30 V DC	
	Max. switching power (resistive load)	1,250 VA, 150 W	
	Max. switching voltage	250 V (AC), 110 V (DC)	
	Max. switching current	5 A	
	Nominal operating power	120 mW (5 to 18 V DC), 180 mW (24 V DC)	
	Min. switching capacity (Reference value)*1	100μA 100mV DC	
Electrical characteristics	Insulation resistance (Initial)	Min. 1,000MΩ (at 500V DC) Measurement at same location as "Breakdown voltage" section.	
	Breakdown voltage (Initial)	Between open contacts	1,000 Vrms for 1min. (Detection current: 10mA.)
		Between contact and coil	2,000 Vrms for 1min. (Detection current: 10mA.)
	Surge breakdown voltage (Initial)	Between contacts and coil*2	4,000 V
	Temperature rise (coil) (at 20°C 68°F)		Max. 45°C (By resistive method, nominal coil voltage applied to the coil, nominal switching capacity.)
	Operate time (at nominal voltage) (at 20°C 68°F)		Max. 10 ms
Release time (at nominal voltage) (at 20°C 68°F)		Max. 5 ms	
Mechanical characteristics	Shock resistance	Functional	Min. 147 m/s <sup>2</sup> (Half-wave pulse of sine wave: 11 ms; detection time: 10μs.)
		Destructive	Min. 980 m/s <sup>2</sup> (Half-wave pulse of sine wave: 6 ms.)
	Vibration resistance	Functional	10 to 55 Hz at double amplitude of 2.5 mm (Detection time: 10μs.)
		Destructive	10 to 55 Hz at double amplitude of 3.5 mm
Expected life	Mechanical	Min. 2×10 <sup>7</sup> (at 180 times/min.)	
	Electrical	Min. 10 <sup>5</sup> (3 A 250 V AC, 30 V DC, resistive load) Min. 5×10 <sup>4</sup> (5 A 250 V AC, 30 V DC, resistive load) (at 20 times/min.)	
Conditions	Conditions for operation, transport and storage*3	Ambient temperature: -40°C to 70°C -40°F to 158°F; Humidity: 5 to 85% R.H. (Not freezing and condensing at low temperature)	
	Max. operating speed	20 times/min. (at nominal switching capacity)	
Unit weight		Approx. 3 g .15 oz	

Notes: \*1. This value can change due to the switching frequency, environmental conditions, and desired reliability level, therefore it is recommended to check this with the actual load.

\*2. Wave is standard shock voltage of ±1.2×50μs according to JEC-212-1981

\*3. The upper limit of the ambient temperature is the maximum temperature that can satisfy the coil temperature rise value. Refer to Usage, transport and storage conditions in NOTES.

## REFERENCE DATA

### 1. Max. switching capacity

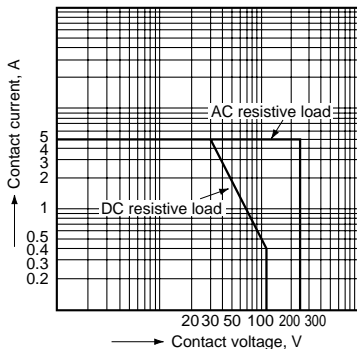

### 2. Life curve

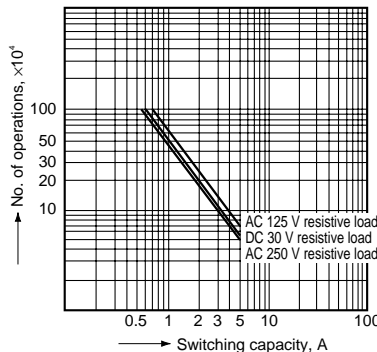

### 3.-(1) Coil temperature rise (180 mW)

Tested sample: PA1a-24V

Measured portion: Inside the coil

Ambient temperature: 20°C 68°F

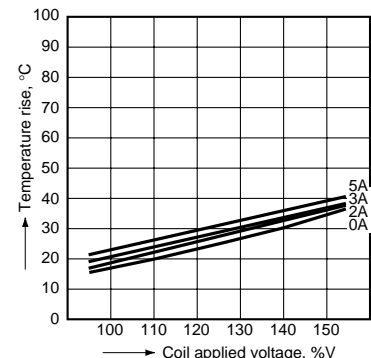

3.-(2) Coil temperature rise (120 mW)  
 Tested sample: PA1a-12V  
 Measured portion: Inside the coil  
 Ambient temperature: 20°C 68°F

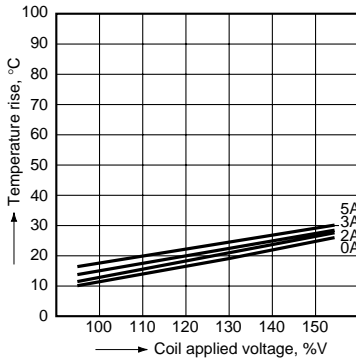

4.-(1) Operate & release time (120 mW)  
 Tested sample: PA1a-12V, 20 pcs.

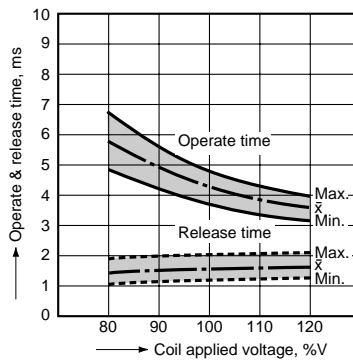

4.-(2) Operate & release time (180 mW)  
 Tested sample: PA1a-24V, 20 pcs.

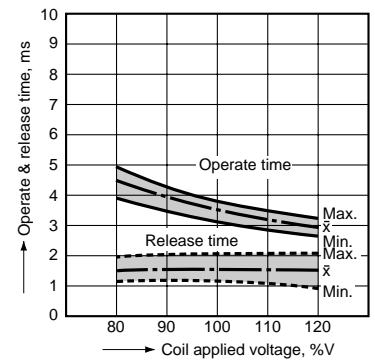

5. Ambient temperature characteristics  
 Tested sample: PA1a-12V, 6 pcs.

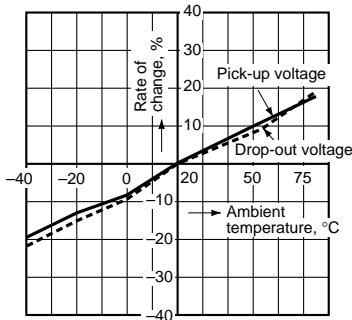

6. Malfunctional shock  
 Tested sample: PA1a-12V, 6 pcs.

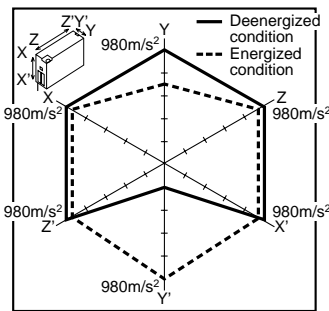

## DIMENSIONS (mm inch)

The CAD data of the products with a **CAD Data** mark can be downloaded from: <http://industrial.panasonic.com/ac/e/>

### Relay

**CAD Data**

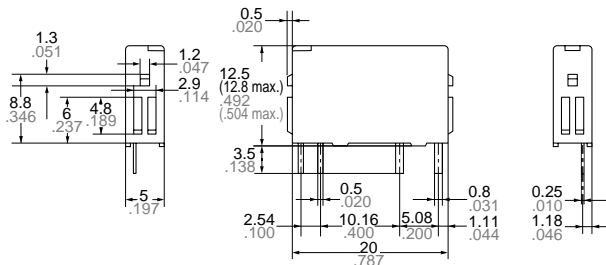

General tolerance:  $\pm 0.3 \pm 0.12$

### PC board pattern (Bottom view)

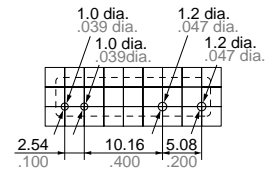

Tolerance:  $\pm 0.1 \pm 0.04$

### Schematic (Bottom view)

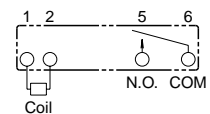

## SAFETY STANDARDS

UL/C-UL (Recognized)		CSA (Certified)		TÜV (Certified)		Remarks
File No.	Contact rating	File No.	Contact rating	File No.	Rating	
E43149	5A 250V AC (5×10 <sup>4</sup> ) 5A 30V DC (5×10 <sup>4</sup> ) 3A 250V AC (10 <sup>5</sup> ) 3A 30V DC (10 <sup>5</sup> )	LR26550 etc.	5A 250V AC (5×10 <sup>4</sup> ) 5A 30V DC (5×10 <sup>4</sup> ) 3A 250V AC (10 <sup>5</sup> ) 3A 30V DC (10 <sup>5</sup> )	B 12 01 13461 316	IEC1131-2 Reinforced	TÜV rating 5A 250V AC (cosφ=1.0) (5×10 <sup>4</sup> ) 5A 30V DC (0ms) (5×10 <sup>4</sup> ) 3A 250V AC (cosφ=1.0) (10 <sup>5</sup> ) 3A 30V DC (0ms) (10 <sup>5</sup> )

# NOTES

1. For cautions for use, please read "GENERAL APPLICATION GUIDELINES" on page B-1.
2. If it includes ripple, the ripple factor should be less than 5%.
3. Specification values for pick-up and drop-out voltages are for the relay mounting with its terminals below.

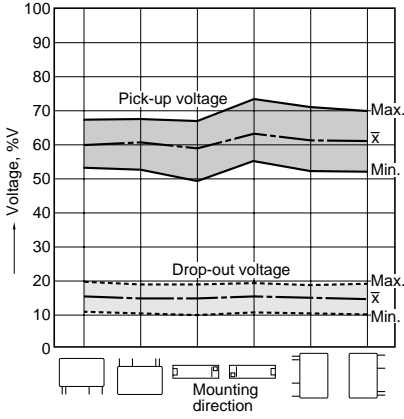

4. When mounting the relays within 1 mm .039 inch, please notice the condition below.

- 1) Mount the relays in the same direction.

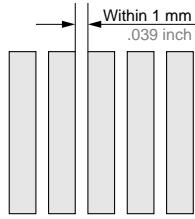

- 2) Coil terminals (Terminal No. 1 & 2) polarity should be arranged in the same direction.

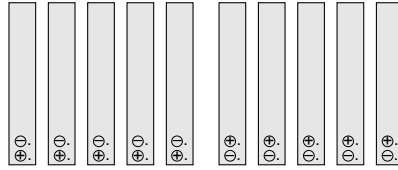

- 3) Allowable contact current is 2 A.

- 4) About the electrical life for close mounting, please refer to data below.

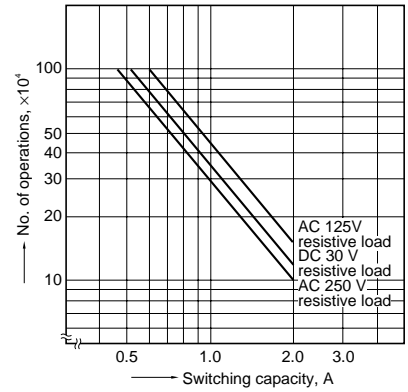
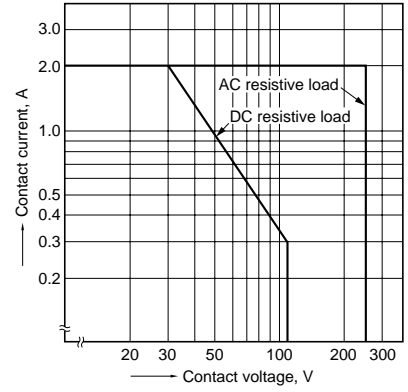

### ACCESSORIES

### PA RELAYS TERMINAL SOCKETS



Standard type terminal socket



Self clinching type terminal socket

### TYPES

Product name	Part No.
Standard type terminal socket	PA1a-PS
Self clinching type terminal socket	PA1a-PS-H

### DIMENSIONS (mm inch)

The CAD data of the products with a **CAD Data** mark can be downloaded from: <http://industrial.panasonic.com/ac/e/>

#### Standard type terminal socket

**CAD Data**

#### External dimensions

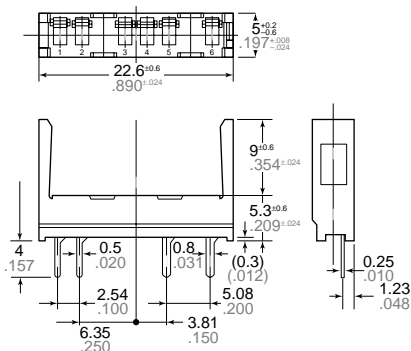

General tolerance:  $\pm 0.3 \pm 0.12$

#### PC board pattern (Bottom view)

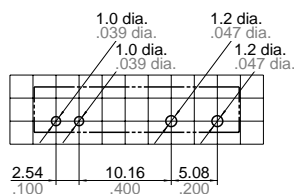

Tolerance:  $\pm 0.1 \pm 0.04$

#### Self clinching type terminal socket

**CAD Data**

#### External dimensions

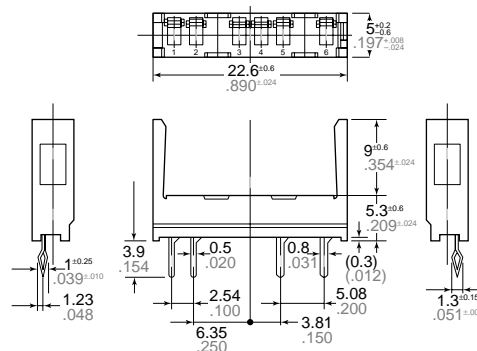

General tolerance:  $\pm 0.3 \pm 0.12$

#### PC board pattern (Bottom view)

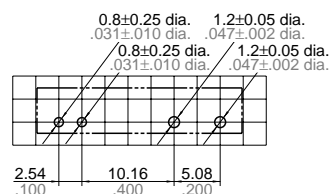

Tolerance:  $\pm 0.1 \pm 0.04$

### INSTALLING AND REMOVING

#### Installing and removing the relay

1) Firmly insert the relay into the socket with the terminals going in the direction of the blade receptacles.

(1) Insert the removal key into the socket slots.

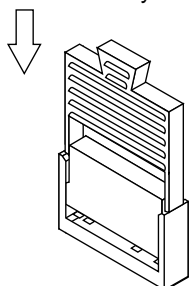

2) The relay can be easily removed using the removal key (APA801).

(2) Pull the removal key up to remove the relay.

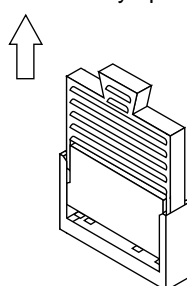

(3) Slide the removal key off of the relay.

