

# G3VM-353B/E

MOS FET Relays

DIP 6-pin package, Analog-switching  
MOS FET Relays with SPST-NC Contact.

RoHS compliant



Note: The actual product is marked differently from the image shown here.

## Application Examples

- Communication equipment
- Security systems
- FA systems
- Test & Measurement equipment

## Terminal Arrangement/Internal Connections

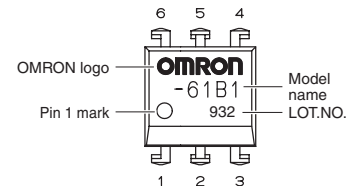
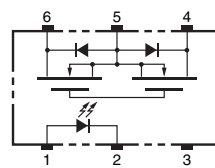

Note: The actual product is marked differently from the image shown here.

## List of Models

Package type	Contact form	Terminals	Load voltage (peak value) *	Model	Minimum package quantity	
					Number per tube	Number per tape and reel
DIP6	1b (SPST-NC)	PCB Terminals	350 V	G3VM-353B	50	-
		Surface-mounting Terminals		G3VM-353E		
				G3VM-353E (TR)	-	1,500

\* The AC peak and DC value are given for the load voltage.

## Absolute Maximum Ratings (Ta = 25°C)

Item		Symbol	Rating	Unit	Measurement conditions
Input	LED forward current	$I_F$	50	mA	
	Repetitive peak LED forward current	$I_{FP}$	1	A	100 $\mu$ s pulses, 100 pps
	LED forward current reduction rate	$\Delta I_F / ^\circ C$	-0.5	mA/ $^\circ C$	Ta $\geq 25^\circ C$
	LED reverse voltage	$V_R$	5	V	
Connection temperature		$T_J$	125	$^\circ C$	
Load voltage (AC peak/DC)		$V_{OFF}$	350	V	
Output	Continuous load current	Connection A	150	mA	Connection A: AC peak/DC Connection B and C: DC
		Connection B	150		
		Connection C	300		
	ON current reduction rate	$\Delta I_o / ^\circ C$	-1.5	mA/ $^\circ C$	Ta $\geq 25^\circ C$
Connection temperature		$T_J$	125	$^\circ C$	
Dielectric strength between I/O (See note 1.)		$V_{I-O}$	2500	Vrms	AC for 1 min
Ambient operating temperature		Ta	-40 to +85	$^\circ C$	With no icing or condensation
Ambient storage temperature		Tstg	-55 to +125	$^\circ C$	With no icing or condensation
Soldering temperature		-	260	$^\circ C$	10 s

Note: 1. The dielectric strength between the input and output was checked by applying voltage between all pins as a group on the LED side and all pins as a group on the light-receiving side.

### Connection Diagram

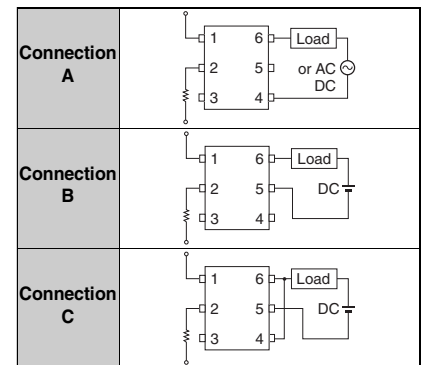

## Electrical Characteristics (Ta = 25°C)

Item		Symbol	Minimum	Typical	Maximum	Unit	Measurement conditions
Input	LED forward voltage	$V_F$	1.0	1.15	1.3	V	$I_F = 10$ mA
	Reverse current	$I_R$	-	-	10	$\mu A$	$V_R = 5$ V
	Capacity between terminals	$C_T$	-	30	-	pF	$V = 0, f = 1$ MHz
Trigger LED forward current		$I_{FC}$	-	1	3	mA	$I_{OFF} = 10$ $\mu A$
Output	Maximum resistance with output ON	Connection A	-	15	25	$\Omega$	$I_o = 150$ mA
		Connection B	-	8	14	$\Omega$	$I_o = 150$ mA
		Connection C	-	4	7	$\Omega$	$I_o = 300$ mA
Current leakage when the relay is open		$I_{LEAK}$	-	-	1.0	$\mu A$	$I_F = 5$ mA, $V_{OFF} = 350$ V
Capacity between terminals		$C_{OFF}$	-	85	-	pF	$V = 0, f = 1$ MHz, $I_F = 5$ mA
Capacity between I/O terminals		$C_{I-O}$	-	0.8	-	pF	$f = 1$ MHz, $V_s = 0$ V
Insulation resistance between I/O terminals		$R_{I-O}$	1000	-	-	M $\Omega$	$V_{I-O} = 500$ VDC, $R_oH \leq 60\%$
Turn-ON time		$t_{ON}$	-	0.1	1.0	ms	$I_F = 5$ mA, $R_L = 200$ $\Omega$ , $V_{DD} = 20$ V (See note 2.)
Turn-OFF time		$t_{OFF}$	-	1.0	3.0	ms	

Note: 2. Turn-ON and Turn-OFF Times

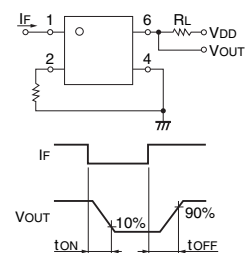

## Recommended Operating Conditions

Use the G3VM under the following conditions so that the Relay will operate properly.

Item	Symbol	Minimum	Typical	Maximum	Unit
Load voltage (AC peak/DC)	$V_{DD}$	-	-	280	V
Operating LED forward current	$I_F$	5	-	25	mA
Continuous load current (AC peak/DC)	$I_o$	-	-	150	mA
Ambient operating temperature	$T_a$	-20	-	65	°C

## Engineering Data

LED forward current vs. Ambient temperature

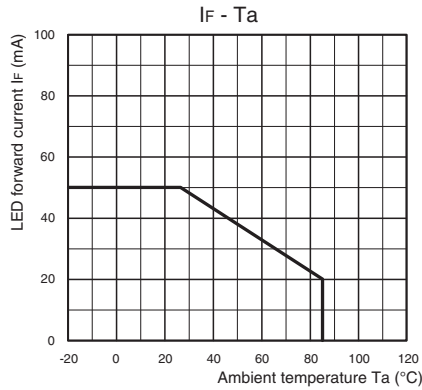

Continuous load current vs. Ambient temperature

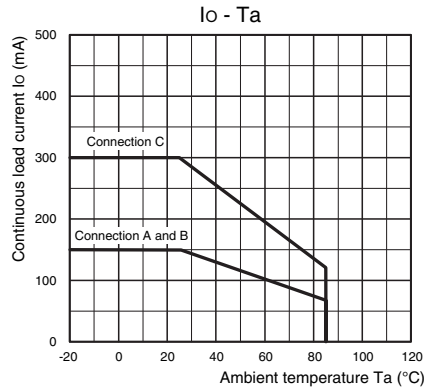

LED forward current vs. LED forward voltage

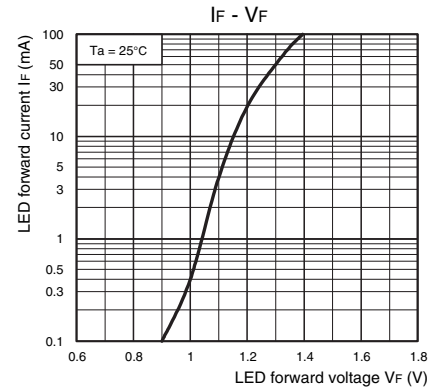

Continuous load current vs. On-state voltage

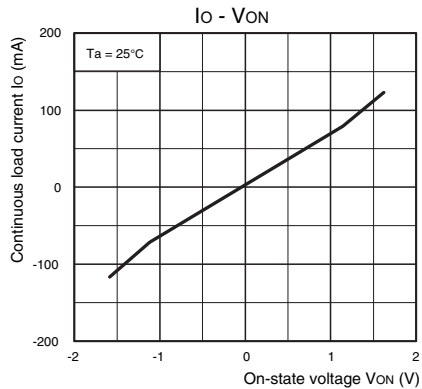

On-state resistance vs. Ambient temperature

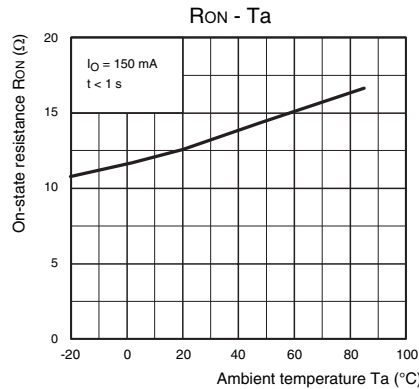

Trigger LED forward current vs. Ambient temperature

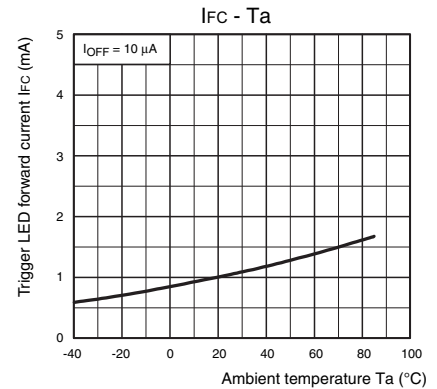

Turn ON, Turn OFF time vs. LED forward current

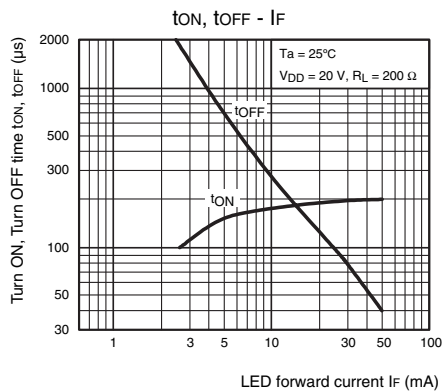

Turn ON, Turn OFF time vs. Ambient temperature

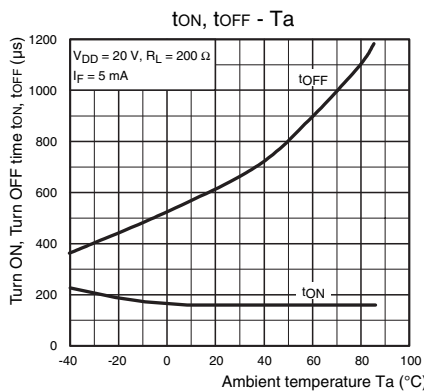

Current leakage vs. Ambient temperature

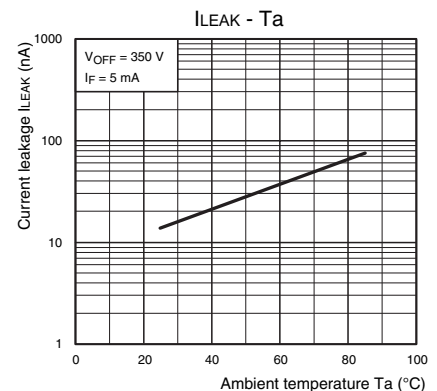

## Safety Precautions

- Refer to "Common Precautions" for all G3VM models.

## ■ Appearance

### DIP (Dual Inline Package)

DIP6

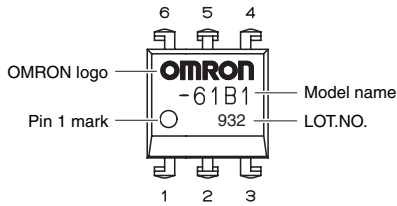

Note: The actual product is marked differently from the image shown here.

## ■ Dimensions

(Unit: mm)



### PCB Terminals

Weight: 0.4 g

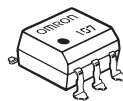
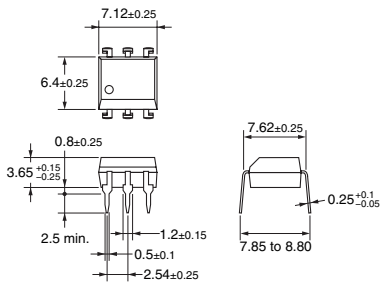

### Surface-mounting Terminals

Weight: 0.4 g

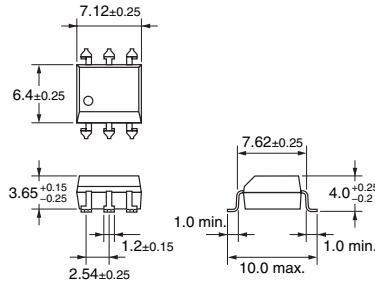

### PCB Dimensions (BOTTOM VIEW)

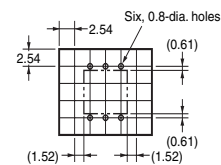

### Actual Mounting Pad Dimensions

(Recommended Value, TOP VIEW)

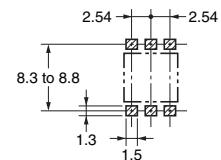

Note: The actual product is marked differently from the image shown here.

- Application examples provided in this document are for reference only. In actual applications, confirm equipment functions and safety before using the product.
- Consult your OMRON representative before using the product under conditions which are not described in the manual or applying the product to nuclear control systems, railroad systems, aviation systems, vehicles, combustion systems, medical equipment, amusement machines, safety equipment, and other systems or equipment that may have a serious influence on lives and property if used improperly. Make sure that the ratings and performance characteristics of the product provide a margin of safety for the system or equipment, and be sure to provide the system or equipment with double safety mechanisms.

Note: Do not use this document to operate the Unit.

**OMRON Corporation**

ELECTRONIC AND MECHANICAL COMPONENTS COMPANY

Contact: [www.omron.com/ecb](http://www.omron.com/ecb)

Cat. No. K249-E1-01  
0413(0413)(O)