

# MCZ5607SC

## Driver IC

### Feature

- Floating Channel for Bootstrap Operation to +600V
- Output Source / Sink Current : 220mA/450mA
- 3.3 V and 5 V input logic compatible
- Pb free
- RoHS:Yes

### Outline

House Name: SOP8J



## 1. 絶対最大定格

### Absolute Maximum Ratings

以下、IN1,IN2=IN と省略する。

Abridgement each as follows IN1,IN2=IN

### 1-1 入出力規格

#### Input Output Ratings

特に指定のない場合はTj=25°C  
Tj=25°C unless otherwise specified.

項目 Item	記号 Symbol	規格値 Ratings	単位 Units
Vcc端子最大印加電圧 Vcc maximum applied voltage	Vcc	-0.3 ~ 22	V
IN端子最大印加電圧 IN maximum applied voltage	VIN	-0.3 ~ 6.0	V
VB端子最大印加電圧 VB maximum applied voltage	VB	-0.3 ~ 6.22	V
VS端子最大印加電圧 VS maximum applied voltage	VS	VB-22 ~ VB+0.3	V
VB-VS最大印加電圧 VB-VS maximum applied voltage	VBS	-0.3 ~ 22	V
HO端子最大出力電圧 HO maximum output voltage	VHO	VS-0.3 ~ VB+0.3	V
LO端子最大出力電圧 LO maximum output voltage	VLO	-0.3 ~ Vcc+0.3	V
dVS/dt 最大許容オフセット電圧 dVS/dt offset voltage maximum	dVS/dt	50	V/ns

注意 : 本仕様書に記載されていない項目、使用条件、論理の組み合わせでの使用は保証していません。

記載されている以外の条件で使用する場合は必ず事前に当社担当営業部門までご相談下さい。

記載内容は改良などのためにお断り無しに変更することがあります。

Notes : Using with parameters, condition of use and logic controls that are not specified in the specifications are not assured.

When used with the conditions that are not specified, please consult us in advance.

The contents described herein are subject to change without notice.

### 1-2 熱規格

#### Thermal Ratings

特に指定のない場合はVcc=VB=16V, VS=GND, Tj=25°C  
Vcc=VB=16V, VS=GND and Tj=25°C unless otherwise specified.

項目 Item	記号 Symbol	規格値 Ratings	単位 Units
保存温度 Storage temperature	Tstg	-55 ~ 150	°C
接合部温度 Junction temperature	Tj	-40 ~ 150	°C
許容損失 Total power dissipation	Pd	1.25 (※1)	W
熱抵抗 Thermal resistance	Rth(j-a)	100 (※1)	°C/W

※1 ガラエポ基板: 114.3mm × 76.2mm, 厚: 1.6mm, 内部銅箔サイズ: 74.2mm × 74.2mm, 厚: 35μm

Glass-Epoxy Borad: 114.3mm × 76.2mm, Thickness: 1.6mm, Inside copper foil: 74.2mm × 74.2mm, Thickness: 35μm

## 2. 推奨動作条件

### Recommended Operation Conditions

特に指定のない場合は $V_{CC}=V_B=16V, V_S=GND, T_J=25^{\circ}C$   
 $V_{CC}=V_B=16V, V_S=GND$  and  $T_J=25^{\circ}C$  unless otherwise specified.

項目 Item	記号 Symbol	推奨値 Recommended value			単位 Units
		最小 min	標準 typ	最大 max	
動作温度 Operating temperature	$T_{J(ope)}$	-40	---	125	$^{\circ}C$
$V_{CC}$ 端子印加電圧 $V_{CC}$ applied voltage	$V_{CC}$	10	---	20	V
IN端子印加電圧 IN applied voltage	VIN	0	---	5.5	V
VB端子印加電圧 VB applied voltage	VB	$V_S+10$	---	$V_S+20$	V
VS端子印加電圧 VS applied voltage	VS	0	---	500	V
VB-VS端子印加電圧 VB-VS applied voltage	VBS	10	---	20	V
HO端子出力電圧 HO output voltage	VHO	VS	---	VB	V
LO端子出力電圧 LO output voltage	VLO	0	---	$V_{CC}$	V

**注意** : 上記の規格範囲内においても、製品寿命に関しましてはお客様の使用環境により異なりますので、長寿命を期待される製品にご使用される場合には、 $T_J=105^{\circ}C$ 以下でご使用頂く事を推奨致します。

**Notes** : The product life depends on the condition of use even within the above operating conditions. Using at  $T_J = 105^{\circ}C$  or less is recommended for the equipment where a long life is expected.

### 3. 電気的特性

#### Electrical Characteristics

特に指定のない場合はVcc=VB=16V, VS=GND, Tj=25°C  
Vcc=VB=16V, VS=GND and Tj=25°C unless otherwise specified.

項目 Item	記号 Symbol	条件 Conditions	規格値 Ratings			単位 Units
			最小 min	標準 typ	最大 max	
Vcc起動電圧 Vcc start-up voltage	Vcc_start	-	8.40	8.90	9.40	V
Vcc停止電圧 Vcc stop voltage	Vcc_stop	-	7.70	8.20	8.70	V
Vcc UVLO ヒステリシス Vcc UVLO hysteresis voltage	Vcc_UVLO_Δ	Δ = Vcc_start - Vcc_stop	0.40	0.70	1.00	V
Vcc消費電流 Vcc operating current	Icc	IN1, IN2=0V	170	340	680	μA
VB-VS起動電圧 VBS start-up voltage	VBS_start	-	8.40	8.90	9.40	V
VB-VS停止電圧 VBS stop voltage	VBS_stop	-	7.70	8.20	8.70	V
VBS UVLO ヒステリシス VBS UVLO hysteresis voltage	VBS_UVLO_Δ	Δ = VBS_start - VBS_stop	0.40	0.70	1.00	V
VBS消費電流 VBS operating current	IBS	IN1, IN2=0V	110	220	440	μA
ハイサイド最低動作電圧(※1) High side minimum operating voltage	VBS_min	-			5.0	V
ローサイド最低動作電圧(※1) Low side minimum operating voltage	Vcc_min	-			5.0	V
最小固定デッドタイム Dead time	DT	-	90	180	270	ns
ターンオン伝達遅延時間 Turn-on propagation delay time	ton	CL=1000pF	120	240	360	ns
ターンオフ伝達遅延時間 Turn-off propagation delay time	toff	CL=1000pF	130	270	410	ns
遅延時間差 propagation delay time	DM	Δ ton (HS-LS) Δ toff (HS-LS)	-50	0	50	ns
IN端子 上側しきい値電圧 Input upper threshold voltage	VIH	-	1.6	2.0	2.4	V
IN端子 下側しきい値電圧 Input lower threshold voltage	VIL	-	0.8	1.1	1.4	V
IN端子しきい値ヒステリシス電圧 Input threshold hysteresis voltage	VINhys	VINhys=VIH-VIL	0.5	0.9	1.3	V
出力ソース電流 Output source current	IHO_H ILO_H	IN1=5V, HO-VS=0V IN2=5V, LO-GND=0V	160	220	280	mA
出力シンク電流 Output sink current	IHO_L ILO_L	IN1=0V, HO-VS=16V IN2=0V, LO-GND=16V	340	450	560	mA
出力立上り時間(※1)(※2) Output rise time	tr	CL=1000pF		75		ns
出力立下がり時間(※1)(※2) Output fall time	tf	CL=1000pF		30		ns
入力フィルタ時間1 Input filter time1	tFILIN1	Positive pulse, IN1, IN2			250	ns
入力フィルタ時間2 Input filter time2	tFILIN2	Negative pulse, IN1, IN2			350	ns
入出力パルス幅差 Output pulse width match	Δ PwIO	Pw(IN) - Pw(OUT) , Pw(IN) > 1us		30	120	ns

(※1) 設計保証

Design assurance.

(※2) Vcc=16V(10%→1.6V, 90%→14.4V)

4. 端子配置および端子機能  
Pin Assignment & Pin Function

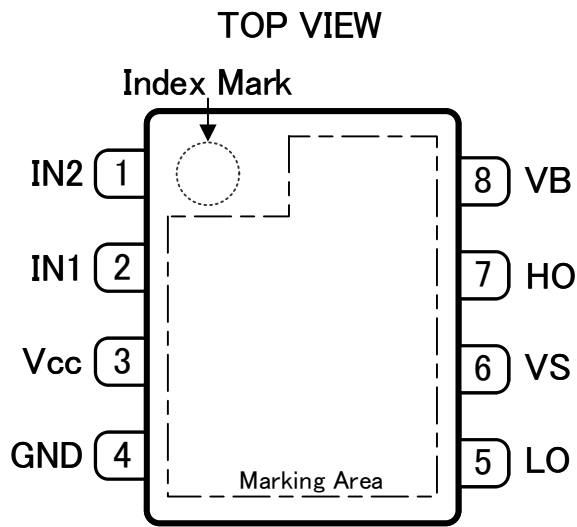

端子番号 Pin No.	端子名 Pin Name	機能 Function
1	IN2	入力端子2 Input2 terminal
2	IN1	入力端子1 Input1 terminal
3	Vcc	電源端子 Input terminal for power supply
4	GND	GND端子 Ground terminal
5	LO	ドライバ2出力端子 Driver2 output terminal
6	VS	ドライバ1基準端子 Driver1 ground terminal
7	HO	ドライバ1出力端子 Driver1 output terminal
8	VB	ドライバ1電源端子 Driver1 input terminal for power supply

5. ブロック図  
Block Diagram

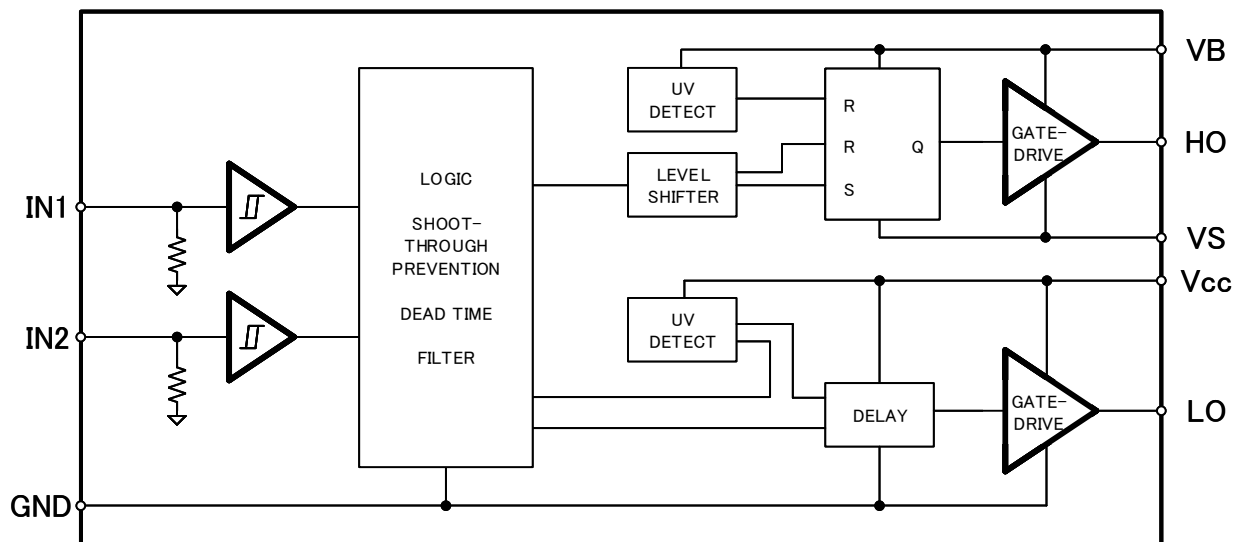

6. タイミングチャートおよび真理値表  
Timing diagram & Truth table

6-1 タイミングチャート  
Timing diagram

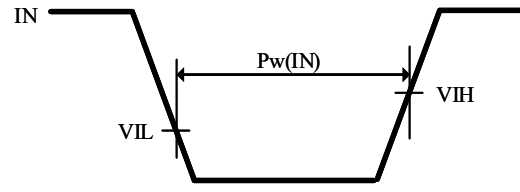
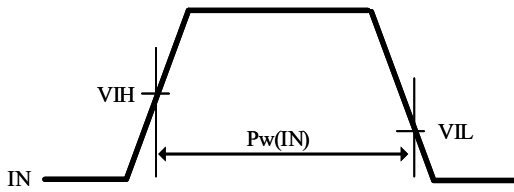
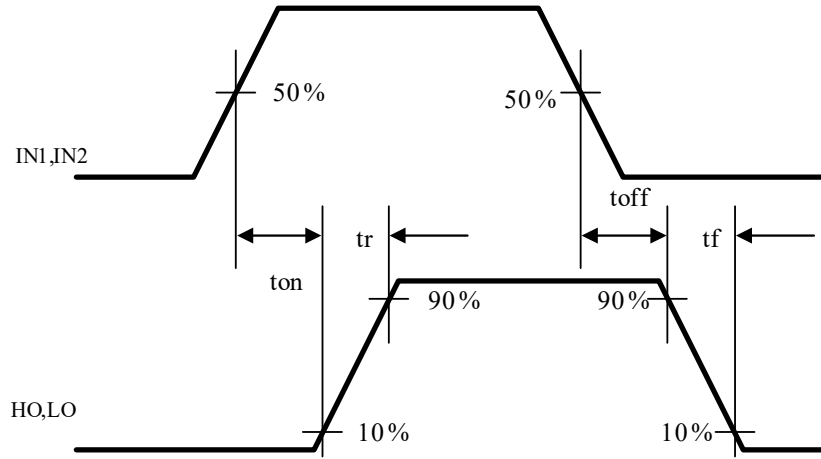

①  $Pw(IN) < tFILIN$

(1) Positive pulse

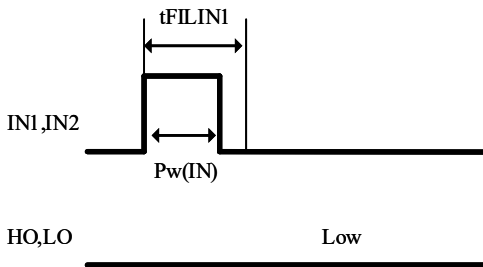

(2) Negative pulse

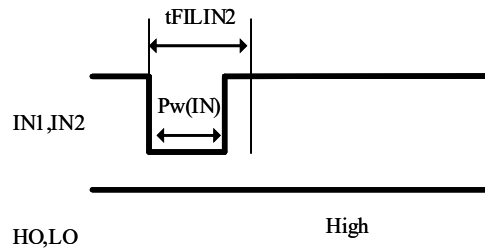

②  $Pw(IN) > tFILIN$

(1) Positive pulse

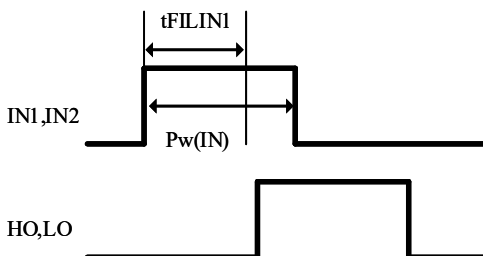

(2) Negative pulse

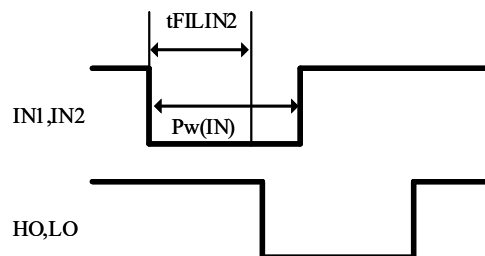

6-2 真理値表 (- : H or L)

Truth table (- : H or L)

IN1	IN2	Vcc	VBS	HO	LO
-	-	L	L	L	L
-	-	L	H	L	L
-	L	H	L	L	L
L	L	H	H	L	L
L	H	H	L	L	H
L	H	H	H	L	H
H	L	H	H	H	L
H	H	H	L	L	L
H	H	H	H	L	L

Vcc(VBS):『H』は、Vcc(VBS)がVcc\_start(VBS\_start)以上、またはVcc\_stop(VBS\_stop)以上(UVLO解除後)

Vcc(VBS):『L』は、Vcc(VBS)がVcc\_stop(VBS\_stop)以下、またはVcc\_start(VBS\_start)以下(UVLO解除前)

UVLO解除後: Vcc\_start(VBS\_start)以上の電圧印加をした状態

UVLO解除前: 起動時、またはUVLO解除後に、Vcc\_stop(VBS\_stop)以下の電圧印加をした状態

Vcc(VBS):『H』 is the case where Vcc(VBS) is Vcc\_start(VBS\_start) or more, or more than Vcc\_stop(VBS\_stop) (After UVLO is released.)

Vcc(VBS):『L』 is the case where Vcc(VBS) is Vcc\_stop(VBS\_stop) or less, or less than Vcc\_start(VBS\_start). (Before UVLO is released.)

After UVLO release: In a state where a voltage of Vcc\_start(VBS\_start) or more is applied.

Before UVLO release: At the time of startup or after UVLO released, a state in which a voltage of Vcc\_stop (VBS\_stop) or less is applied.

# Package Outline-Dimensions

unit : mm  
scale: 4/1

L2

JEDEC Code	-
JEITA Code	-
House Name	SOP8J

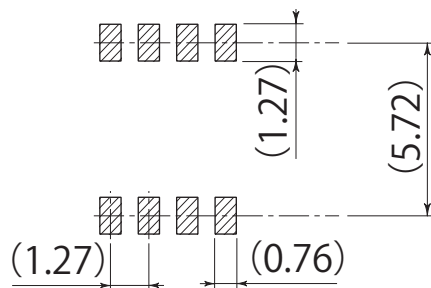
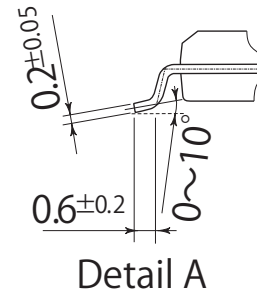
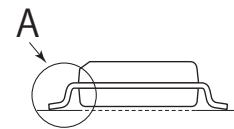
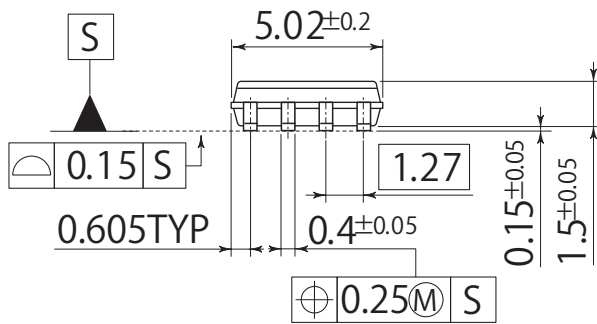
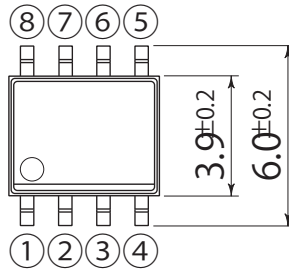

## Referential Soldering Pad

- 量産時には、適正化を図って下さい
- Optimize soldering pad to the board design and soldering condition.

- 本資料の記載内容は、改良のため予告なく変更することがあります
- ご使用にあたりましては、別途仕様書を必ずご請求下さい
- The content specified herein is subject to change for improvement without notice.
- If you wish to use any such products, please be sure to refer to the specifications.

U182(2019.02)



## Notes

1. If you wish to use any such product, please be sure to refer to the specifications issued by Shindengen.
2. All products described or contained herein are designed with a quality level intended for use in standard applications requiring an ordinary level of reliability. If these products are to be used in equipment or devices for special or specific applications requiring an extremely high grade of quality or reliability in which failures or malfunctions of products may directly affect human life or health, a local Shindengen office must be contacted in advance to confirm that the intended use of the product is appropriate. Shindengen products are grouped into the following three applications according to the quality grade.
  - 【Standard applications】  
Computers, office automation and other office equipment, communication terminals, test and measurement equipment, audio/visual equipment, amusement equipment, consumer electronics, machine tools, personal electronic equipment, industrial equipment, etc.
  - 【Special applications】  
Transportation equipment (vehicles, ships, etc.), trunk-line communication equipment, traffic signal control systems, anti-disaster/crime systems, safety equipment, medical equipment, etc.
  - 【Specific applications】  
Nuclear reactor control systems, aircraft, aerospace equipment, submarine repeaters, life support equipment and systems, etc.
3. Although Shindengen continuously endeavors to enhance the quality and reliability of its products, customers are advised to consider and take safety measures in their design, such as redundancy, fire containment and anti-failure, so that personal injury, fires, or societal damages can be prevented.
4. Please note that all information described or contained herein is subject to change without notice due to product upgrades and other reasons. When buying Shindengen products, please contact the Company's offices or distributors to obtain the latest information.
5. Shindengen shall not bear any responsibility with regards to damages or infringement of any third-party patent rights and other intellectual property rights incurred due to the use of information on this website.
6. The information and materials on this website neither warrant the use of Shindengen's or any third party's patent rights and other intellectual property rights, nor grant license to such rights.
7. In the event that any product described or contained herein falls under the category of strategic products controlled under the Foreign Exchange and Foreign Trade Control Law of Japan, exporting of such products shall require an export license from the Japanese government in accordance with the above law.
8. No reprinting or reproduction of the materials on this website, either in whole or in part, is permitted without proper authorization from Shindengen.