

### Driver Characteristics

Parameter	Rating	Units
$V_{\text{OFFSET}}$	1200	V
$I_{\text{O } \pm}$ (Source/Sink)	2/2	A
$V_{\text{OUT}}$	15-20	V
$t_{\text{on}}/t_{\text{off}}$	250/210	ns

### Features

- Floating Channel for Bootstrap Operation to +1200V
- Outputs Capable of Sourcing and Sinking 2A
- Gate Drive Supply Range From 15V to 20V
- Enhanced Robustness due to SOI Process
- Tolerant to Negative Voltage Transients: dV/dt Immune
- 3.3V Logic Compatible
- Undervoltage Lockout for Both High-Side and Low-Side Outputs



### Description

The IX2120 is a high voltage integrated circuit that can drive high speed MOSFETs and IGBTs that operate at up to +1200V. The IX2120 is configured with independent high-side and low-side referenced output channels, both of which can source and sink 2A. The floating high-side channel can drive an N-channel power MOSFET or IGBT 1200V from the common reference.

Manufactured on IXYS Integrated Circuits Division's proprietary high-voltage BCDMOS on SOI (silicon on insulator) process, the IX2120 is extremely robust, and is virtually immune to negative transients. The UVLO circuit prevents turn-on of the MOSFET or IGBT until there is sufficient  $V_{\text{BS}}$  or  $V_{\text{CC}}$  supply voltage.

The IX2120 is available in a 28-pin SOIC package.

### Ordering Information

Part	Description
IX2120B	28-Pin SOIC (28/Tube)
IX2120BTR	28-Pin SOIC (1000/Reel)

### IX2120 Functional Block Diagram

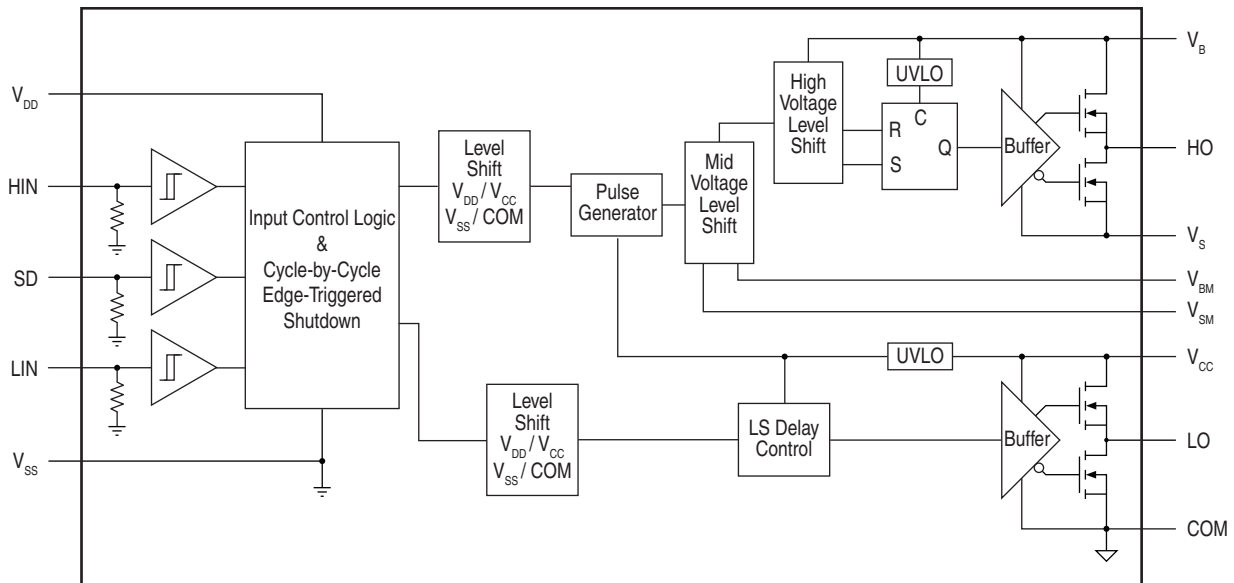

---

<b>1. Specifications</b> .....	<b>3</b>
1.1 Package Pinout: 28-Pin SOIC Package .....	3
1.2 Pin Description: 28-Pin SOIC Package .....	3
1.3 Absolute Maximum Ratings .....	4
1.4 Thermal Characteristics .....	4
1.5 Recommended Operating Conditions .....	4
1.6 Dynamic Electrical Characteristics .....	5
1.7 Static Electrical Characteristics .....	5
1.8 Test Waveforms .....	6
1.9 IX2120 Typical Application .....	7
<b>2. Typical Performance Data</b> .....	<b>8</b>
<b>3. Manufacturing Information</b> .....	<b>12</b>
3.1 Moisture Sensitivity .....	12
3.2 ESD Sensitivity .....	12
3.3 Soldering Profile .....	12
3.4 Board Wash .....	12
3.5 Mechanical Dimensions .....	13

# 1 Specifications

Typical values are characteristic of the device at +25°C, and are the result of engineering evaluations. They are provided for information purposes only, and are not part of the manufacturing testing requirements.

## 1.1 Package Pinout: 28-Pin SOIC Package

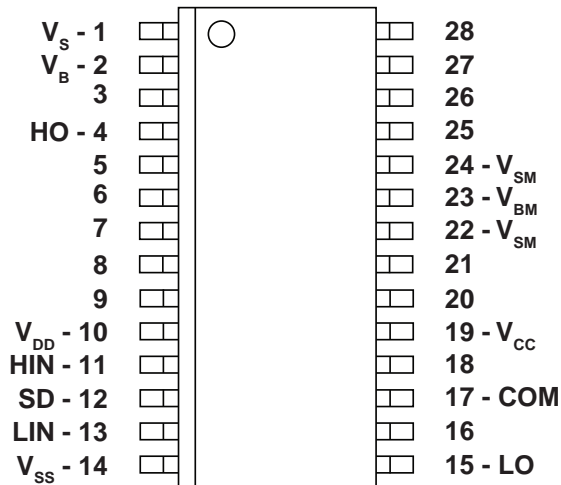

## 1.2 Pin Description: 28-Pin SOIC Package

Pin#	Name	Description
1	$V_S$	High-Side Floating Supply Return
2	$V_B$	High-Side Floating Supply
3	-	No Connection
4	HO	High-Side Gate Drive Output
5	-	No Connection
6	-	No Connection
7	-	Internal Connection, Do Not Use
8	-	No Connection
9	-	Internal Connection, Do Not Use
10	$V_{DD}$	Logic Supply
11	HIN	Logic Input for High-Side Gate Drive Output (HO), In-Phase
12	SD	Logic Input for Shutdown
13	LIN	Logic Input for Low-Side Gate Driver Output (LO), In-Phase
14	$V_{SS}$	Logic Ground
15	LO	Low-Side Gate Drive Output
16	-	No Connection
17	COM	Low-Side Return
18	-	No Connection
19	$V_{CC}$	Low-Side Supply
20	-	Internal Connection, Do Not Use
21	-	No Connection
22	$V_{SM}$	Middle Floating Return
23	$V_{BM}$	Middle Floating Supply
24	$V_{SM}$	Middle Floating Return
25	-	No Connection
26	-	No Connection
27	-	No Connection
28	-	No Connection

### 1.3 Absolute Maximum Ratings

Absolute maximum ratings indicate sustained limits beyond which damage to the device may occur. All voltage parameters are absolute voltages referenced to COM.

Parameter	Symbol	Min	Max	Units
High-Side Floating Supply Voltage	$V_B$	-0.3	1400	V
High-Side Floating Supply Offset Voltage	$V_S$	$V_B-20$	$V_B+0.3$	V
High-Side Floating Output Voltage	$V_{HO}$	$V_S-0.3$	$V_B+0.3$	V
Middle Floating Supply Voltage	$V_{BM}$	-0.3	700	V
Middle Floating Supply Offset Voltage	$V_{SM}$	$V_{BM}-20$	$V_{BM}+0.3$	V
Low-Side Fixed Supply Voltage	$V_{CC}$	-0.3	20	V
Low-Side Output Voltage	$V_{LO}$	-0.3	$V_{CC}+0.3$	V
Logic Supply Voltage	$V_{DD}$	-0.3	$V_{SS}+20$	V
Logic Supply Offset Voltage	$V_{SS}$	$V_{CC}-20$	$V_{CC}+0.3$	V
Logic Input Voltage (HIN, LIN, SD)	$V_{IN}$	$V_{SS}-0.3$	$V_{DD}+0.3$	V
Allowable Offset Supply Voltage Transient	$dV_S/dt$	-	50	V/ns
Package Power Dissipation @25°C	$P_D$	-	1.3	W
Junction Temperature	$T_J$	-40	+150	°C
Storage Temperature	$T_S$	-55	+150	°C

### 1.4 Thermal Characteristics

Parameter	Symbol	Rating	Units
Thermal Impedance, Junction to Ambient	$\Theta_{JA}$	74	°C/W

### 1.5 Recommended Operating Conditions

For proper operation, the device should be used within the recommended conditions. The  $V_S$ ,  $V_{SM}$ , and  $V_{SS}$  offset ratings are tested with all supplies biased at a 15V differential.

Parameter	Symbol	Min	Max	Units
High-Side Floating Supply Absolute Voltage	$V_B$	$V_S+15$	$V_S+20$	V
High-Side Floating Supply Offset Voltage	$V_S$	-	1200	
High-Side Floating Output Voltage	$V_{HO}$	$V_S$	$V_B$	
Middle Floating Supply Absolute Voltage	$V_{BM}$	$V_{SM}+15$	$V_{SM}+20$	
Middle Floating Supply Offset Voltage	$V_{SM}$	-	600	
Low-Side Fixed Supply Voltage	$V_{CC}$	15	20	
Low-Side Output Voltage	$V_{LO}$	0	$V_{CC}$	
Logic Supply Voltage	$V_{DD}$	$V_{SS}+3$	$V_{SS}+20$	
Logic Supply Offset Voltage	$V_{SS}$	-5	+5	
Logic Input Voltage (HIN, LIN, SD)	$V_{IN}$	$V_{SS}$	$V_{DD}$	

**1.6 Dynamic Electrical Characteristics**

$V_{CC}$ ,  $V_{DD}=15V$ ;  $V_{BS}$ ,  $V_{BMSM}=13.5V$ ;  $C_L=1000$  pF; and  $V_{SS}=COM$  unless otherwise specified. See “**Test Waveforms**” on page 6.

Parameter	Conditions	Symbol	Min	Typ	Max	Units
Turn-On propagation Delay	$V_S=0V$	$t_{on}$	-	254	-	ns
Turn-Off propagation Delay	$V_{SM}=600V$	$t_{off}$	-	213	-	
Shutdown propagation Delay	$V_S=1200V$	$t_{SD}$	-	207	-	
Turn-On Rise Time	-	$t_r$	-	9.4	-	
Turn-Off Fall Time	-	$t_f$	-	9.7	-	
Delay Matching, HS & LS Turn-On/Off	-	MT	-	-	60	

**1.7 Static Electrical Characteristics**

$V_{CC}$ ,  $V_{BMSM}$ ,  $V_{BS}$ ,  $V_{DD}=15V$ , and  $V_{SS}=COM$  unless otherwise specified. The  $V_{IN}$ ,  $V_{TH}$ , and  $I_{IN}$  parameters are referenced to  $V_{SS}$  and are applicable to all three logic input leads: HIN, LIN, and SD. The  $V_O$  and  $I_O$  parameters are referenced to COM and are applicable to the respective output leads: HO or LO.

Parameter	Conditions	Symbol	Min	Typ	Max	Units
Logic “1” Input Voltage	$V_{DD}=15V$	$V_{IH}$	9.5	-	-	V
Logic “0” Input Voltage		$V_{IL}$	-	-	6	
Logic “1” Input Voltage	$V_{DD}=3V$	$V_{IH}$	2.5	-	-	V
Logic “0” Input Voltage		$V_{IL}$	-	-	0.8	
High-Level Output Voltage, $V_{BIAS}-V_O$	$I_O=0A$	$V_{OH}$	-	1.6	2.5	V
Low-Level Output Voltage, $V_O$	$I_O=20mA$	$V_{OL}$	-	-	0.15	
High Offset Supply Leakage Current	$V_B=V_S=600V$	$I_{HLK}$	-	32	60	$\mu A$
Middle Offset Supply Leakage Current	$V_{BM}=V_{SM}=600V$	$I_{MLK}$	-	32	60	
Quiescent $V_{BS}$ Supply Current	$V_{IN}=0V$ or $V_{DD}$	$I_{QBS}$	-	187	310	
Quiescent $V_{BMSM}$ Supply Current	$V_{IN}=0V$ or $V_{DD}$	$I_{QBMSM}$	-	487	730	
Quiescent $V_{CC}$ Supply Current	$V_{IN}=0V$ or $V_{DD}$	$I_{QCC}$	-	300	420	
Quiescent $V_{DD}$ Supply Current	$V_{IN}=0V$ or $V_{DD}$	$I_{QDD}$	-	-	1	
Logic “1” Input Bias Current	$V_{IN}=V_{DD}$	$I_{IN+}$	-	22	40	$\mu A$
Logic “0” Input Bias Current	$V_{IN}=0V$	$I_{IN-}$	-	-	5	
$V_{BS}$ Supply Undervoltage Positive Going Threshold	-	$V_{BSUV+}$	7.5	8.4	9.7	V
$V_{BS}$ Supply Undervoltage Negative Going Threshold	-	$V_{BSUV-}$	7	7.8	9.4	
$V_{CC}$ Supply Undervoltage Positive Going Threshold	-	$V_{CCUV+}$	7.4	8.4	9.6	
$V_{CC}$ Supply Undervoltage Negative Going Threshold	-	$V_{CCUV-}$	7	7.8	9.4	
Output High Short Circuit Pulsed Current	$V_O=0V$ , $V_{IN}=V_{DD}$ , $PW \leq 10\mu s$	$I_{O+}$	2	-	-	A
Output Low Short Circuit Pulsed Current	$V_O=15V$ , $V_{IN}=0V$ , $PW \leq 10\mu s$	$I_{O-}$	2	-	-	

1.8 Test Waveforms

1.8.1 Switching Time Test Circuit

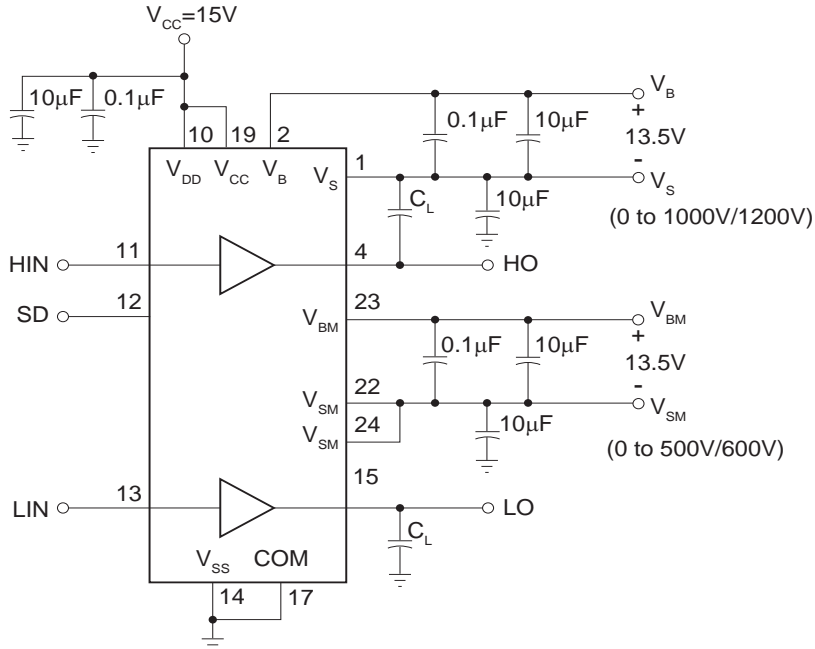

1.8.2 Input/Output Timing Waveform

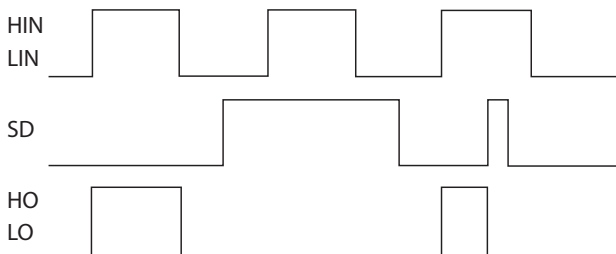

1.8.4 Shutdown Waveform Definitions

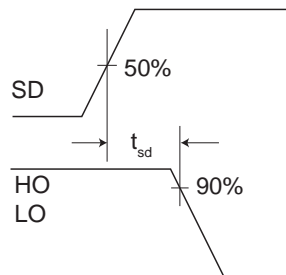

1.8.3 Switching Time Waveform Definition

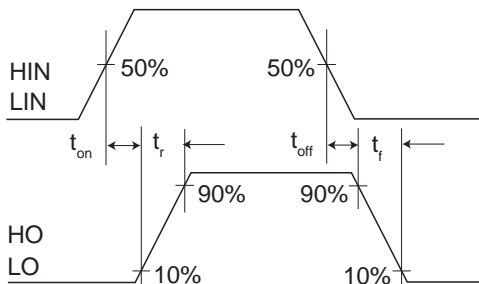

1.8.5 Delay Matching Waveform Definitions

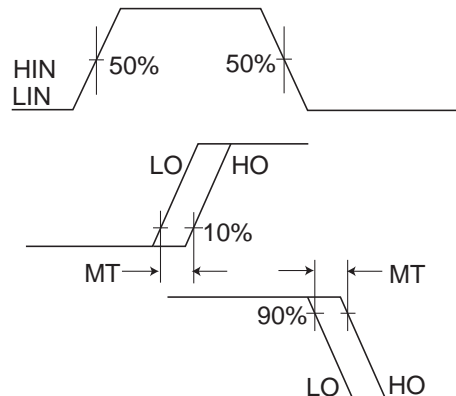

1.9 IX2120 Typical Application

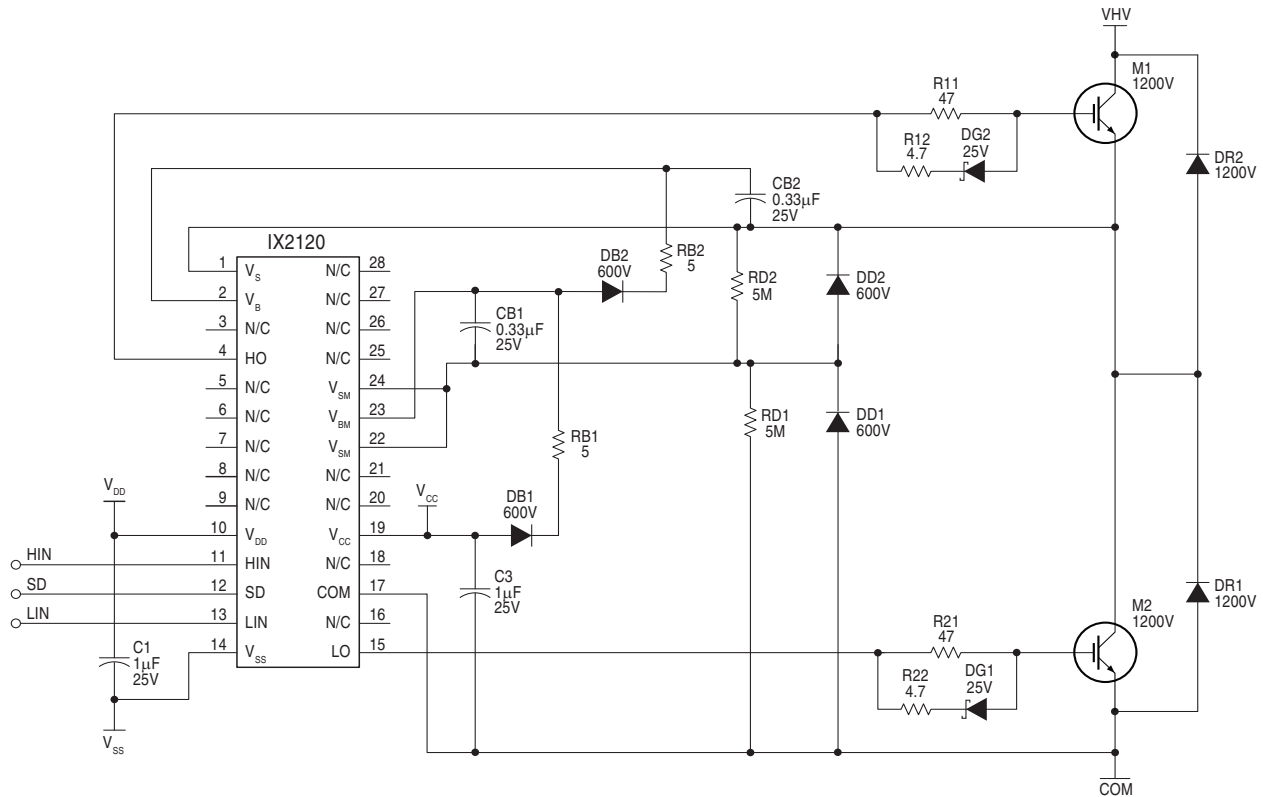

The IX2120 is a 1200V half bridge gate driver for high voltage IGBTs and MOSFETs. Three input signals (HIN, LIN, and SD) determine the state of the gate driver outputs (HO and LO). HIN controls HO via a high voltage interface. The high voltage interface is integrated into the bootstrap supply by using two 600V diodes (DD1 and DD2).

A two-stage bootstrap supplies current to the high side and mid level circuitry. The two bootstrap circuits are identical, and careful board layout and positioning of the bootstrap components are required. Resistors RD1 and RD2 form a resistive divider to keep the mid supply very near the center of the high voltage supply range. High value resistors (5MΩ) are recommended to minimize power dissipation. The two-stage bootstrap supply reduces the high side gate drive voltage (V<sub>B</sub>-V<sub>S</sub>) by two diode forward voltage drops (2V<sub>F</sub>). Therefore, the V<sub>CC</sub> supply range for the application circuit shown is:

$$20V > V_{CC} > (V_{BSUV+} + 2V_F + V_{CE(sat)}M2)$$

Where V<sub>CE(sat)</sub>M2 is the saturation voltage of IGBT, M2.

The high side bootstrap capacitor selection is a function of the switching frequency and the on-time (t<sub>ONTIME</sub>) of the high side source driver. The quiescent V<sub>BS</sub> current (I<sub>QBS</sub>) is supplied by bootstrap capacitor CB2, and the quiescent V<sub>BMSM</sub> supply current (I<sub>QBMSM</sub>) is supplied by bootstrap capacitor CB1. To insure adequate supply current:

$$CB1 > I_{QBS} \cdot \frac{t_{ONTIME}}{V_{CC} - (V_{BSUV+} + 2V_F + V_{CE(sat)}M2)}$$

and:

$$CB2 > I_{QBMSM} \cdot \frac{t_{ONTIME}}{V_{CC} - (V_{BSUV+} + 2V_F + V_{CE(sat)}M2)}$$

## 2 Typical Performance Data

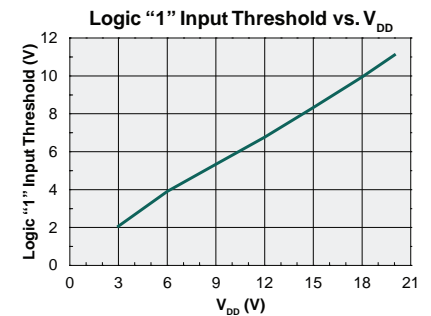
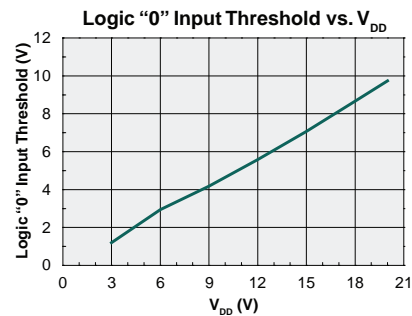
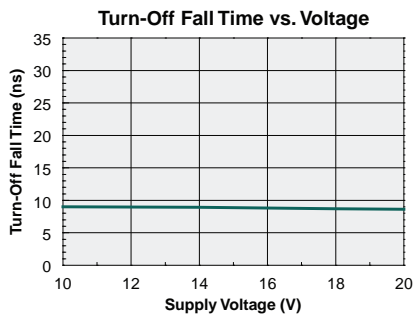
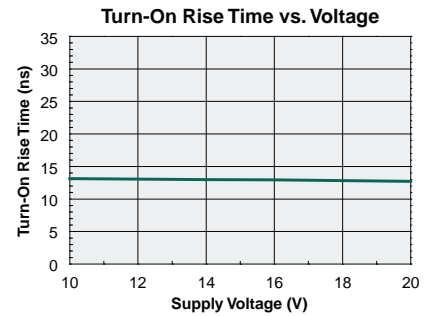
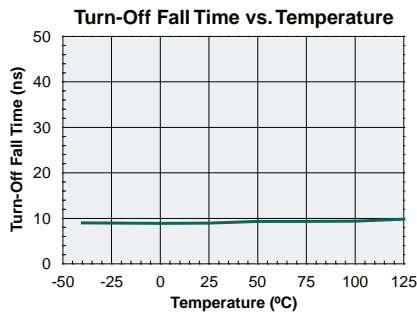
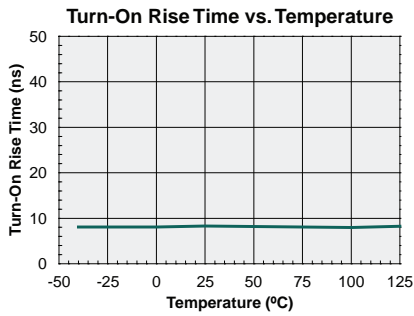
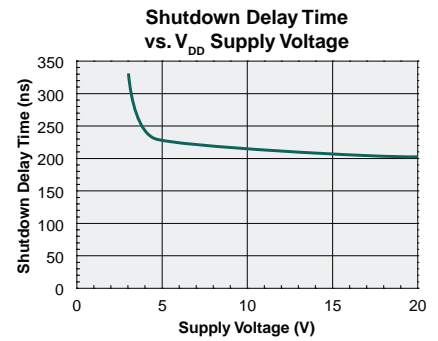
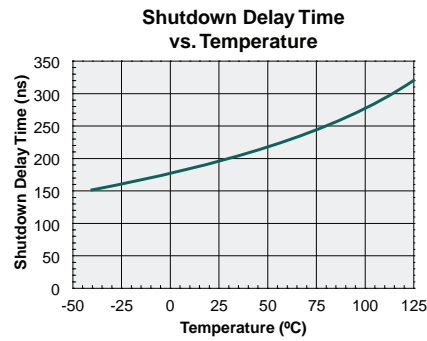
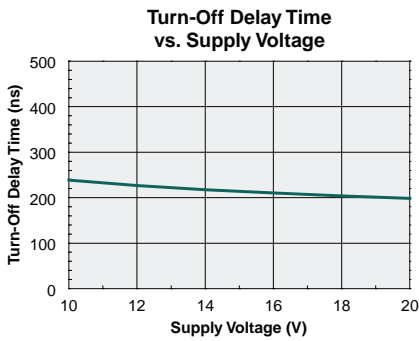
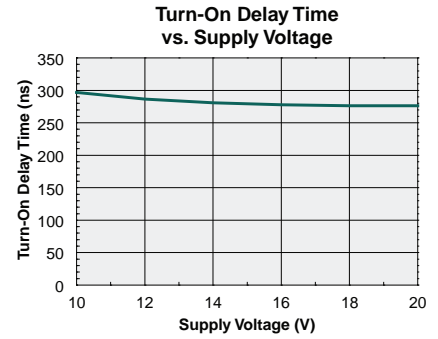
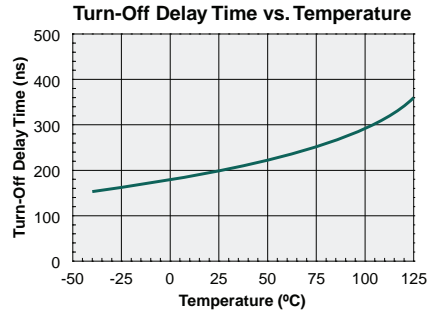
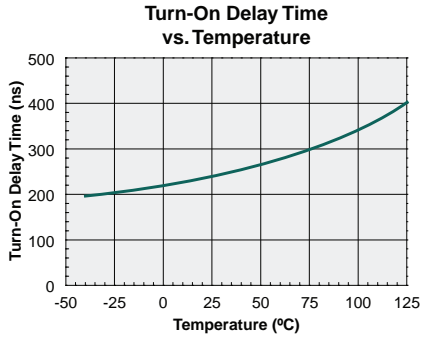



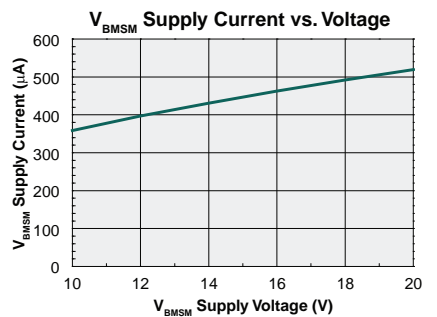
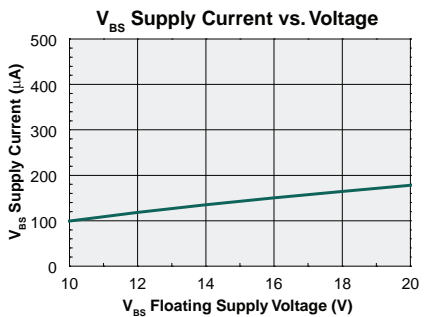
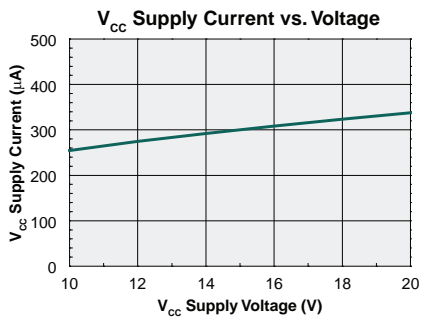
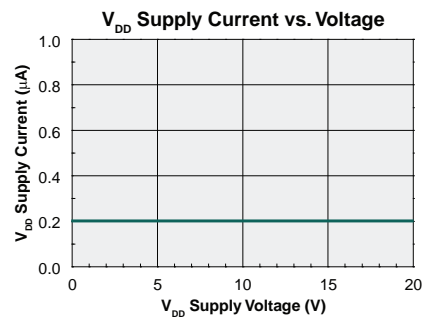
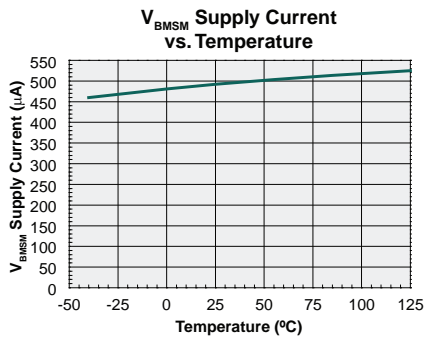
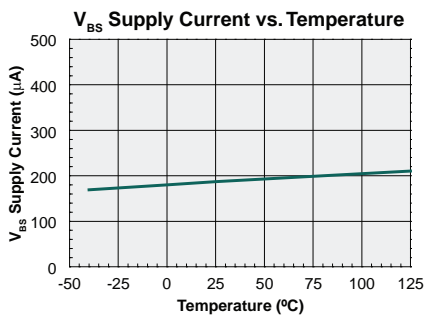
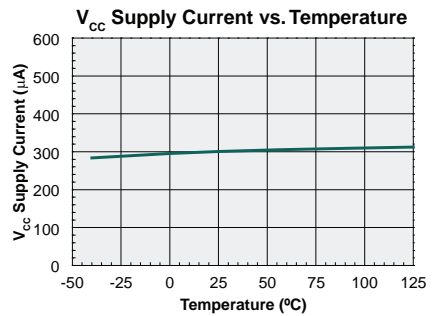
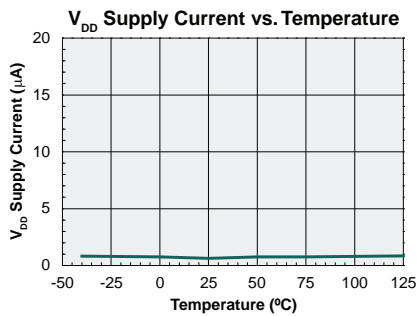
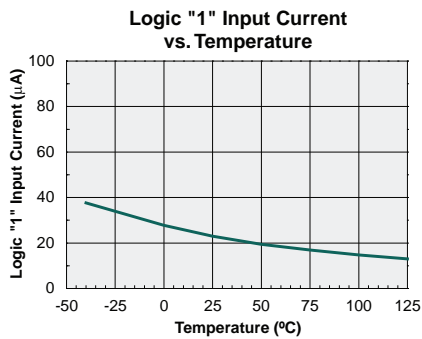
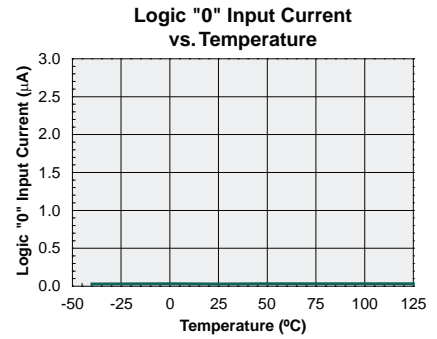
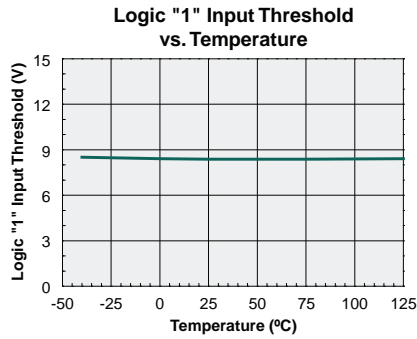
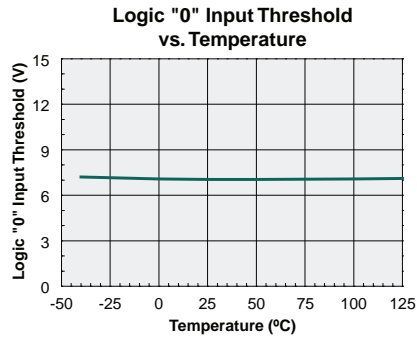

High/Middle Supply Leakage Current vs. Temperature

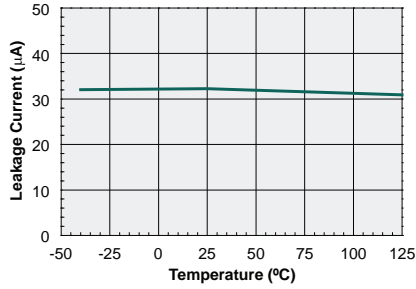

High/Middle Supply Leakage Current vs.  $V_B/V_{BM}$  Voltage

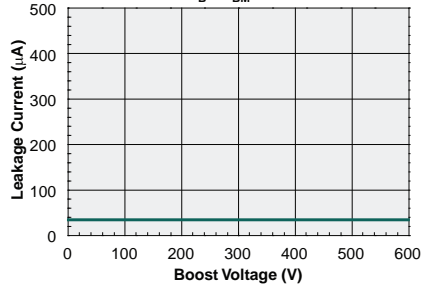

$V_{CCUV+}$  vs. Temperature

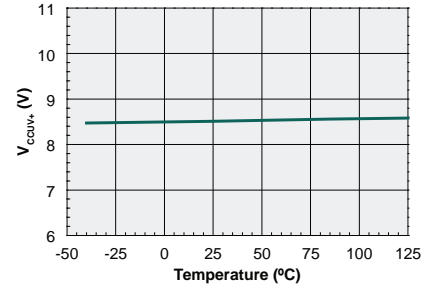

$V_{CCUV-}$  vs. Temperature

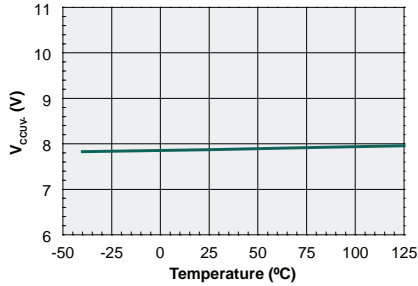

$V_{BSUV+}$  vs. Temperature

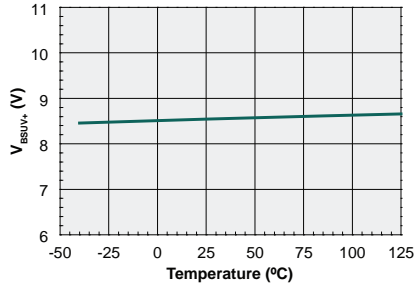

$V_{BSUV-}$  vs. Temperature

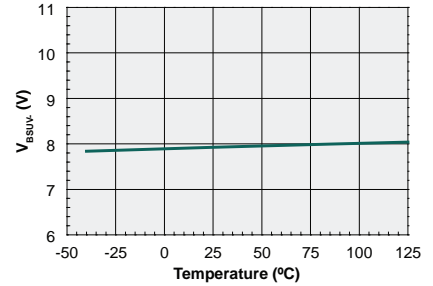

High Level Output Voltage vs. Temperature ( $I_o=0mA$ )

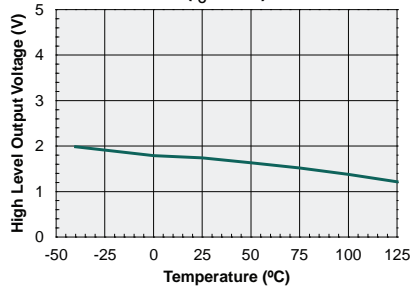

Low Level Output Voltage vs. Temperature ( $I_o=20mA$ )

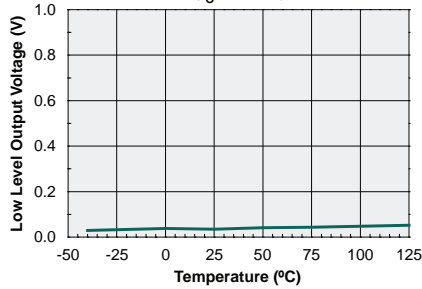

Output Source Current vs. Temperature

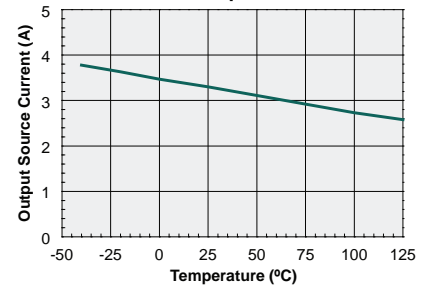

Output Sink Current vs. Temperature

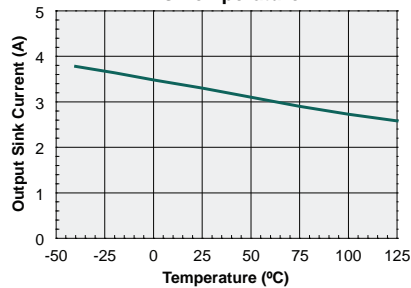

Output Source Current vs. Voltage

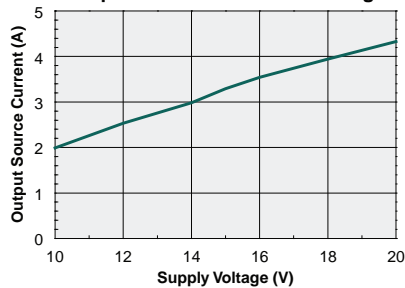

Output Sink Current vs. Voltage

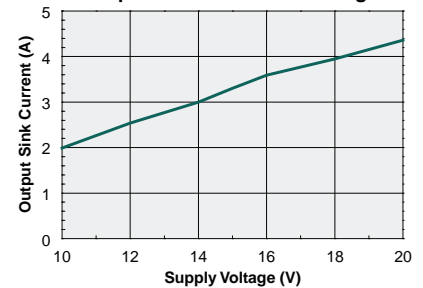

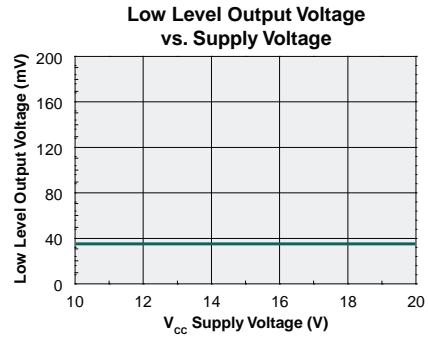
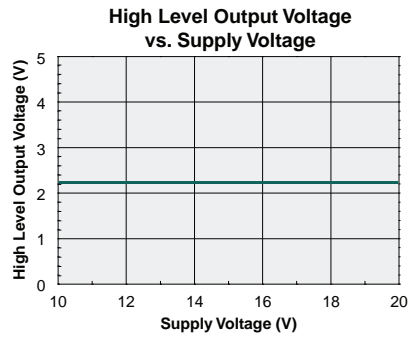

### 3 Manufacturing Information

#### 3.1 Moisture Sensitivity



All plastic encapsulated semiconductor packages are susceptible to moisture ingress. IXYS Integrated Circuits Division classified all of its plastic encapsulated devices for moisture sensitivity according to the latest version of the joint industry standard, **IPC/JEDEC J-STD-020**, in force at the time of product evaluation. We test all of our products to the maximum conditions set forth in the standard, and guarantee proper operation of our devices when handled according to the limitations and information in that standard as well as to any limitations set forth in the information or standards referenced below.

Failure to adhere to the warnings or limitations as established by the listed specifications could result in reduced product performance, reduction of operable life, and/or reduction of overall reliability.

This product carries a **Moisture Sensitivity Level (MSL)** classification as shown below, and should be handled according to the requirements of the latest version of the joint industry standard **IPC/JEDEC J-STD-033**.

Device	Moisture Sensitivity Level (MSL) Classification
IX2120B	MSL 1

#### 3.2 ESD Sensitivity



This product is **ESD Sensitive**, and should be handled according to the industry standard **JESD-625**.

#### 3.3 Soldering Profile

Provided in the table below is the Classification Temperature ( $T_C$ ) of this product and the maximum dwell time the body temperature of this device may be above ( $T_C - 5$ )°C. The classification temperature sets the Maximum Body Temperature allowed for this device during lead-free reflow processes. For through hole devices, and any other processes, the guidelines of **J-STD-020** must be observed.

Device	Classification Temperature ( $T_C$ )	Dwell Time ( $t_p$ )	Max Reflow Cycles
IX2120B	260°C	30 seconds	3

#### 3.4 Board Wash

IXYS Integrated Circuits Division recommends the use of no-clean flux formulations. Board washing to reduce or remove flux residue following the solder reflow process is acceptable provided proper precautions are taken to prevent damage to the device. These precautions include, but are not limited to: using a low pressure wash and providing a follow up bake cycle sufficient to remove any moisture trapped within the device due to the washing process. Due to the variability of the wash parameters used to clean the board, determination of the bake temperature and duration necessary to remove the moisture trapped within the package is the responsibility of the user (assembler). Cleaning or drying methods that employ ultrasonic energy may damage the device and should not be used. Additionally, the device must not be exposed to flux or solvents that are Chlorine- or Fluorine-based.



### 3.5 Mechanical Dimensions

#### 3.5.1 IX2120: 28-Pin SOIC Package

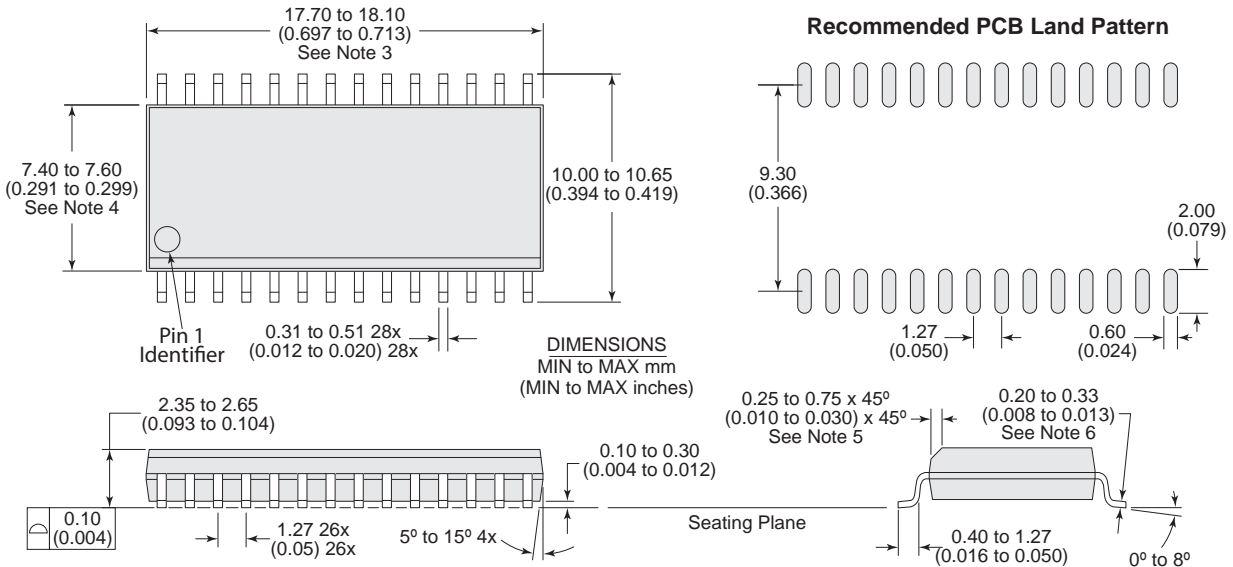

- Notes:
- All dimensions are in mm / (inches).
  - This package conforms to JEDEC Standard MS-013, variation AE issue C.
  - Dimension does not include mold flash, protrusions, or gate burrs. Mold flash, protrusions, or gate burrs shall not exceed 0.15mm per end.
  - Dimension does not include interlead flash or protrusion. Interlead flash or protrusion shall not exceed 0.25mm per side.
  - This chamfer is optional. If it is not present, then a Pin 1 identifier must be located as shown.
  - The dimension applies to the flat section of the lead between 0.10mm to 0.25mm from the lead tip.

#### 3.5.2 IX2120 Tape & Reel Information

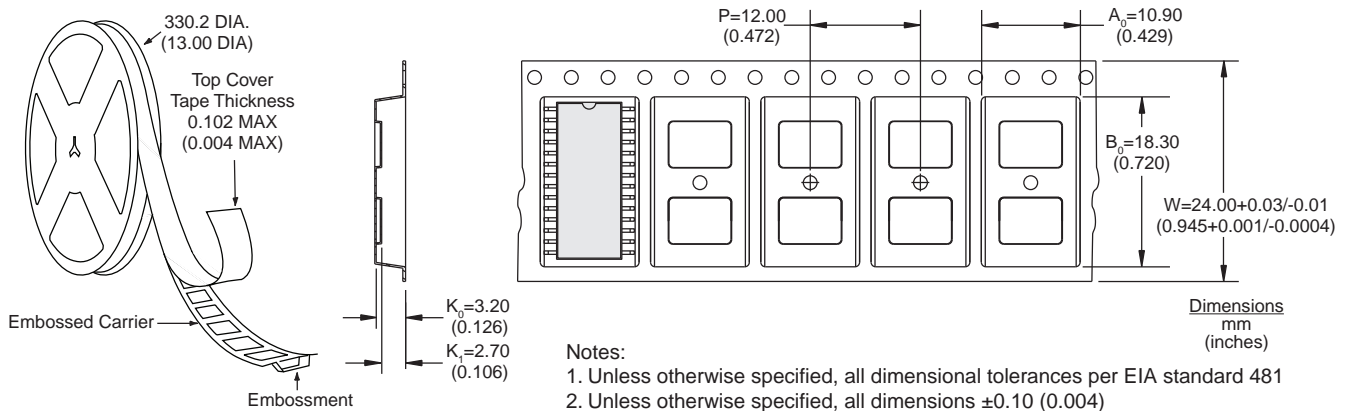

For additional information please visit our website at: [www.ixysic.com](http://www.ixysic.com)

IXYS Integrated Circuits Division makes no representations or warranties with respect to the accuracy or completeness of the contents of this publication and reserves the right to make changes to specifications and product descriptions at any time without notice. Neither circuit patent licenses nor indemnity are expressed or implied. Except as set forth in IXYS Integrated Circuits Division's Standard Terms and Conditions of Sale, IXYS Integrated Circuits Division assumes no liability whatsoever, and disclaims any express or implied warranty, relating to its products including, but not limited to, the implied warranty of merchantability, fitness for a particular purpose, or infringement of any intellectual property right.

The products described in this document are not designed, intended, authorized or warranted for use as components in systems intended for surgical implant into the body, or in other applications intended to support or sustain life, or where malfunction of IXYS Integrated Circuits Division's product may result in direct physical harm, injury, or death to a person or severe property or environmental damage. IXYS Integrated Circuits Division reserves the right to discontinue or make changes to its products at any time without notice.

Specification: DS-IX2120-R02  
 ©Copyright 2016, IXYS Integrated Circuits Division  
 All rights reserved. Printed in USA.  
 2/3/2016