

Dimmer

BTS 629
BTS 629 A

The device allows continuous control of power to a lamp or LED load utilizing pulse-width-modulation.

Features

- High-side switch
- Overtemperature protection
- Short circuit / Overload protection through pulse width reduction an overtemperature shutdown
- Load dump protection up to 93.5 V ¹⁾
- Undervoltage and overvoltage shutdown with auto-restart and hysteresis
- Reverse battery protection ¹⁾
- Timing frequency adjustable
- Controlled switching rise and fall times
- Minimized Radio Frequency Interferences (RFI)
- Maximum current internally limited
- Protection against loss of signal GND ²⁾
- Electrostatic discharge (ESD) protection
- Package: TO-220/7 and SMD, Pin 4 is shorted to the tab

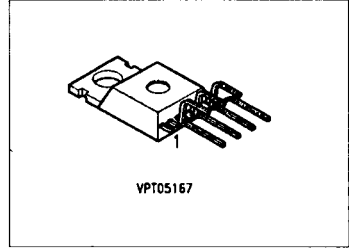

Note:

Switching frequency is programmed with an external capacitor. To assist with accurate setting of this parameter the dimmer is factory selected into two groups (see page 8). For large quantity orders, customer will need to be prepared to accept deliveries of both groups.

Type	Ordering code	Package
BTS 629	C67078-S5501-A2	TO-220/7
BTS 629 A	C67078-S5501-A5	TO-220/7

Maximum Ratings

Parameter	Symbol	Value	Unit
Active overvoltage protection	$V_{bb(AZ)}$	> 50	V
Short-circuit current	I_{SC}	self-limited	-
Operating temperature range	T_j	- 40 ... + 150	°C
Storage temperature range	T_{stg}	- 55 ... + 150	
Power dissipation, $T_C = 25\text{ °C}$	P_{tot}	75	W
Thermal resistance			K/W
Chip - case	R_{thJC}	≤ 1.67	
Chip - ambient	R_{thJA}	≤ 75	

¹⁾ With 150 Ω resistor in Signal GND connection

²⁾ Potential between Signal GND and Load GND > 0.5 V

Electrical Characteristics

at $T_j = 25\text{ }^\circ\text{C}$, unless otherwise specified.

Parameter	Symbol	Values			Unit
		min.	typ.	max.	
PWM reduction threshold (pin 4 to GND), $R_L = 6\ \Omega$	V_{bb}	12.6	13.9	14.1	V
Max. output voltage (RMS) (pin 7 to GND), $R_L = 6\ \Omega$	V_{RMSmax}	12.2	13.5	13.7	
Reference voltage (pin 3 to pin 1) $V_{bb} = 12\text{ V}$, $I_{REF} = 10\text{ mA}$	V_{REF}	2.0	2.5	3.0	
Reference current (pin 3 to pin 1) $V_{bb} = 12\text{ V}$, pin 3 to 1 short	I_{REF}	–	150	–	mA
Internal current consumption during operation (pin 4 to pin 1, measured in PWM gap) $V_{bb} = 12\text{ V}$, R pin 3 to GND = 2.5 k Ω	I_R	–	2.0	3.5	
Bootstrap voltage (pin 6 to pin 7) $V_{bb} = 12\text{ V}$	V_B	–	10	–	
PWM frequency (pin 7 to GND) $V_{bb} = 12\text{ V}$, $T_C = -40 \dots +130\text{ }^\circ\text{C}$ BTS 629 $C_t = 47\text{ nF}$ BTS 629 A $C_t = 68\text{ nF}$	f_{PWM}	60	–	120	Hz
Max. pulse duty factor $V_{bb} = 12\text{ V}$, $R_L = 6\ \Omega$, $V_C = V_{REF} (50\% V_{out})$	D_{tmax}	95	98	–	%
Min. pulse duty factor $V_{bb} = 12\text{ V}$, $R_L = 6\ \Omega$, $V_C = 0 (50\% V_{out})$	D_{tmin}	–	8	14	
Slew rate "on" $V_{bb} = 12\text{ V}$, $R_L = 6\ \Omega$, 10...30% V_{out}	$dv/dt_{(on)}$	–	–	0.12	V/ μs
Slew rate "off" $V_{bb} = 12\text{ V}$, $R_L = 6\ \Omega$, 90...10% V_{out}	$dv/dt_{(off)}$	–	–	0.12	
Slew rate "on" $V_{bb} = 12\text{ V}$, $R_L = 6\ \Omega$, 10...30% I_{out}	$di/dt_{(on)}$	–	–	0.02	A/ μs
Slew rate "off" $V_{bb} = 12\text{ V}$, $R_L = 6\ \Omega$, 90...10% I_{out}	$di/dt_{(off)}$	–	–	0.02	
Thermal overload trip temperature	T_{jt}	150	–	–	$^\circ\text{C}$

Circuits

Analog Logic-Input V_C (2)

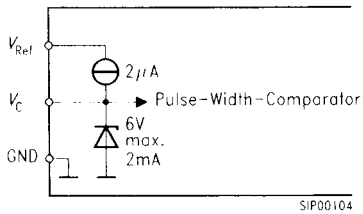

**Triangular wave form
Generator Input C_t (5)**

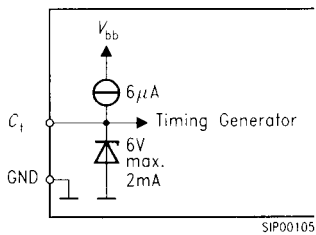

Voltage Sensor (typ)

Undervoltage sensor

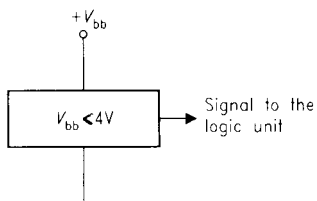

Overvoltage sensor

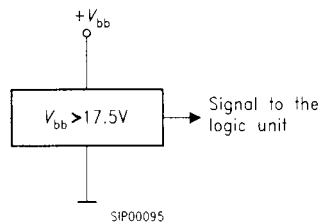

Operating range (typ.)

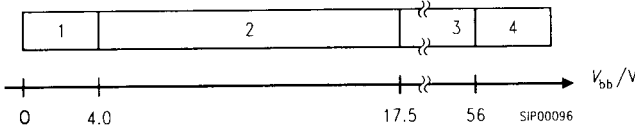

- 1: Undervoltage sensor causes the device to switch off
- 2: Normal operation
- 3: Overvoltage sensor causes the device to switch off (Timing Generator remains active)
- 4: Increase of current between Pin 4 and 1 from internal Zener diode to protect the circuit against overvoltage spikes

Susceptibility to electrical interference
to DIN 40 839 part 1 (12 V supply voltage)*

Test pulse	Susceptibility levels							
	with 150 Ω in GND-line							
	I	II	III	IV	I	II	III	IV
1	X	X	X	X	X	X	X	X
2	X	X	Y	Y	X	X	X	X
3a	X	X	X	X	X	X	X	X
3b	X	X	X	X	X	X	X	X
4	X	X	X	X	X	X	X	X
5	X	X	Y	Y	X	X	X	Y

Class X: All functions of the device are performed as designed after exposure to disturbance

Class Y: One or more functions of the device are not performed as designed after exposure and cannot be returned to proper operation without replacing the device

Test pulse 5: Load dump

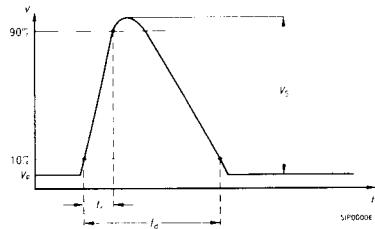

Parameters: $V_S = 50 \text{ V}$ (level II)
 $V_P = 13.5 \text{ V}$
 $R_i = 0.5 \text{ to } 4 \text{ } \Omega$
 $t_d = 40 \text{ to } 400 \text{ ms}$
 $t_r = 0.1 \text{ to } 10 \text{ ms}$

I_{Load} (Pin 7 to GND) = I_{L-ISO} (see page 2)
with 150 Ω in GND-line:
 $V_S = 80 \text{ V}$ (Level III)

Note:
 The condition are related to each other in that the high setting values of V_S , R_i and t_d belong together as do respectively the low values

*) DIN 40839: Electromagnetic compatibility (EMC) in motor vehicles; correlation with ISO-Technical Report 7637/0 and 7637/1.

Susceptibility to electrical interference
to DIN 40 839 part 1 (12 V supply voltage)

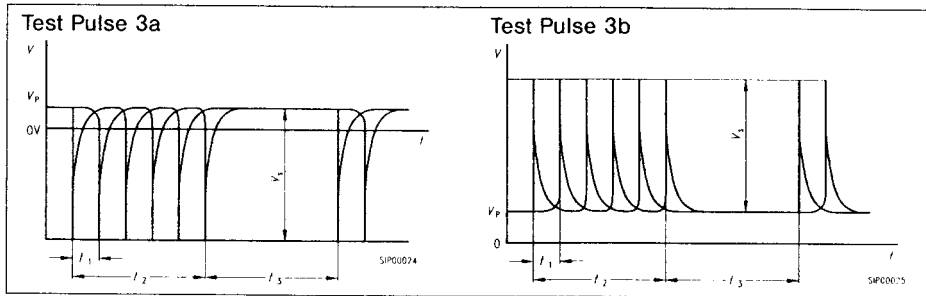

Parameters
 $V_S = -150 \text{ V}$
 $R_1 = 50 \ \Omega$
 $t_d = 0.1 \ \mu\text{s}$
 $t_r = 5 \text{ ns}$
 $t_1 = 100 \ \mu\text{s}$
 $t_2 = 10 \text{ ms}$
 $t_3 = 90 \text{ ms}$

Parameters
 $V_S = 100 \text{ V}$
 $R_1 = 50 \ \Omega$
 $t_d = 0.1 \ \mu\text{s}$
 $t_r = 5 \text{ ns}$
 $t_1 = 100 \ \mu\text{s}$
 $t_2 = 10 \text{ ms}$
 $t_3 = 90 \text{ ms}$

Test circuit

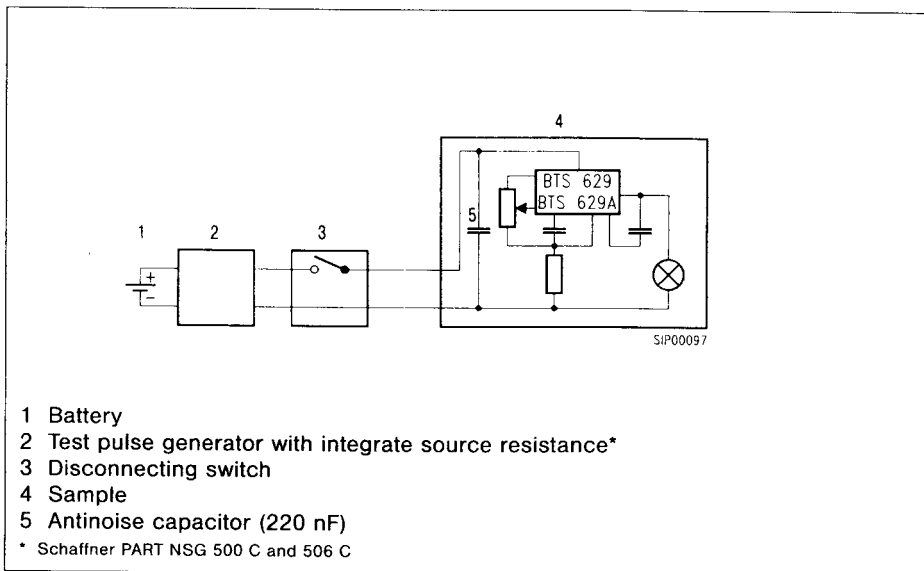

Applications

Dimming of dashboard lighting

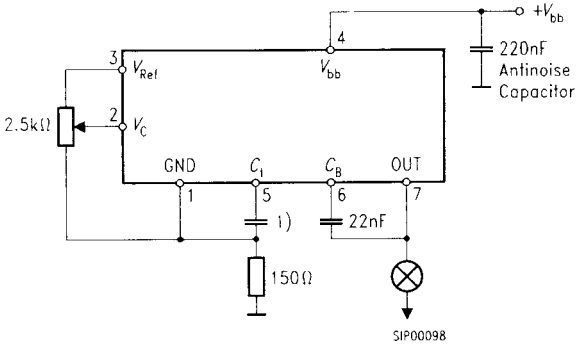

1) BTS 629 $C_1 = 47 \text{ nF}$
BTS 629 A $C_1 = 68 \text{ nF}$

Resistor for
reverse battery and load dump
protection

Maximum Brightness

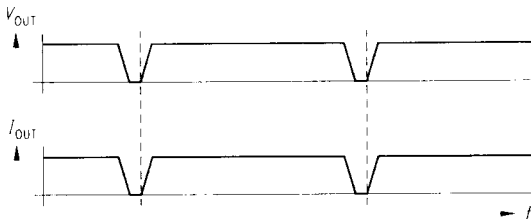

SIP00099

Minimum Brightness

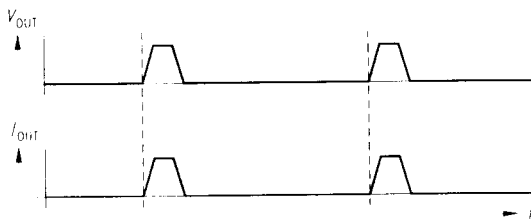

SIP00100

BTS 629
PWM Frequency characteristic
min./max. Values

$C_1 = 47 \text{ nF}$ $V_{bb} = 12 \text{ V}$
 $Q_c \geq 500 / f = 10 \text{ kHz}$ $C_B = 22 \text{ nF}$

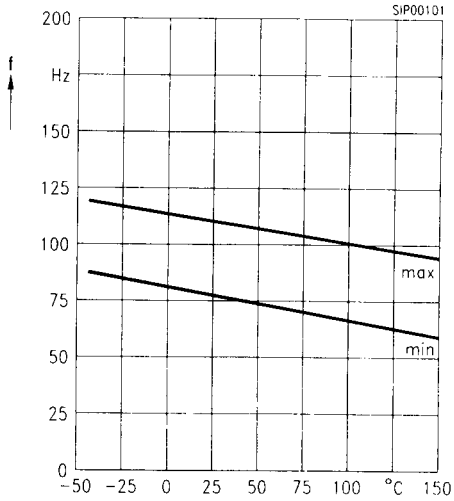

BTS 629A
PWM Frequency characteristic
min./max. Values

$C_1 = 68 \text{ nF}$ $V_{bb} = 12 \text{ V}$
 $Q_c \geq 500 / f = 10 \text{ kHz}$ $C_B = 22 \text{ nF}$

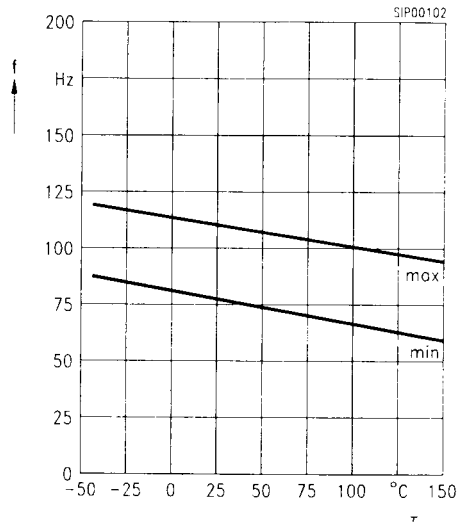

Package

TO-220/7

Weight: 0.5 g

Dimensions in mm

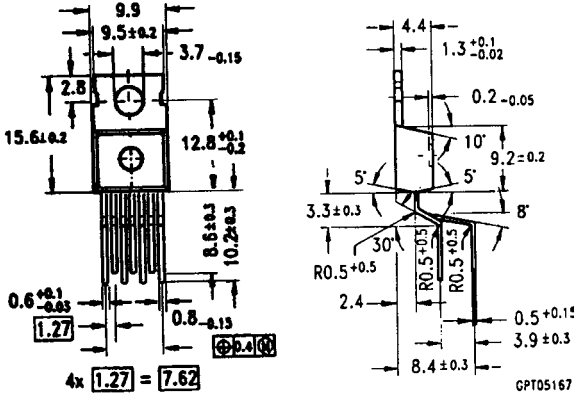

Pin	1	2	3	4	5	6	7
	GND	V _c	V _{REF}	V _{bb}	C ₁	C _B	OUT