

## ULN2003B High-Voltage, High-Current Darlington Transistor Array

### 1 Features

- Greater Than 4x Reduction in Output Leakage ( $I_{CEX}$ ) over ULN2003A
- 500-mA Rated Collector Current (Single Output)
- High-Voltage Outputs 50 V
- Output Clamp Diodes
- Inputs Compatible With Various Types of Logic
- Relay-Driver Applications

### 2 Applications

- Relay Drivers
- Lamp Drivers
- Display Drivers (LED and Gas Discharge)
- Line Drivers
- Logic Buffers

### 3 Description

The ULN2003B device is a high-voltage, high-current Darlington transistor array. This device consists of seven NPN Darlington pairs that feature high-voltage outputs with common-cathode clamp diodes for switching inductive loads. The collector-current rating of a single Darlington pair is 500 mA. The Darlington pairs can be paralleled for higher current capability.

The ULN2003B has a 2.7-k $\Omega$  series base resistor for each Darlington pair for operation directly with TTL or CMOS devices.

#### Device Information<sup>(1)</sup>

PART NUMBER	PACKAGE	BODY SIZE (NOM)
ULN2003BN	PDIP (16)	19.30 mm x 6.35 mm
ULN2003BD	SOIC (16)	9.90 mm x 3.91 mm
ULN2003BPW	TSSOP (16)	5.00 mm x 4.40 mm

(1) For all available packages, see the orderable addendum at the end of the datasheet.

#### Simplified Schematic

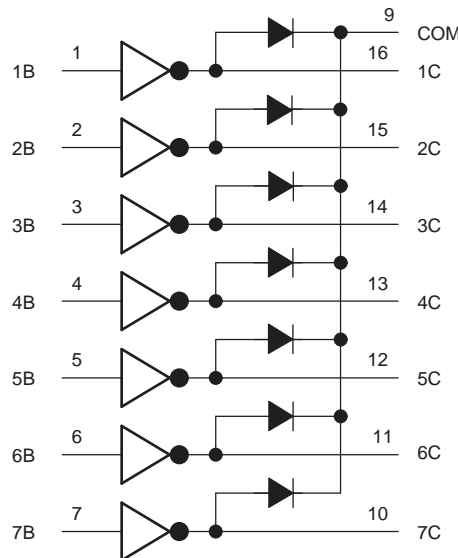

Copyright © 2016, Texas Instruments Incorporated



## Table of Contents

<b>1 Features</b> .....	<b>1</b>	8.2 Functional Block Diagram .....	<b>10</b>
<b>2 Applications</b> .....	<b>1</b>	8.3 Feature Description .....	<b>10</b>
<b>3 Description</b> .....	<b>1</b>	8.4 Device Functional Modes .....	<b>11</b>
<b>4 Revision History</b> .....	<b>2</b>	<b>9 Application and Implementation</b> .....	<b>11</b>
<b>5 Pin Configuration and Functions</b> .....	<b>3</b>	9.1 Application Information .....	<b>11</b>
<b>6 Specifications</b> .....	<b>4</b>	9.2 Typical Application .....	<b>11</b>
6.1 Absolute Maximum Ratings .....	<b>4</b>	<b>10 Power Supply Recommendations</b> .....	<b>13</b>
6.2 ESD Ratings .....	<b>4</b>	<b>11 Layout</b> .....	<b>13</b>
6.3 Recommended Operating Conditions .....	<b>4</b>	11.1 Layout Guidelines .....	<b>13</b>
6.4 Thermal Information .....	<b>4</b>	11.2 Layout Example .....	<b>13</b>
6.5 Electrical Characteristics, $T_A = 25^\circ\text{C}$ .....	<b>5</b>	<b>12 Device and Documentation Support</b> .....	<b>14</b>
6.6 Electrical Characteristics, $T_A = -40^\circ\text{C}$ to $+105^\circ\text{C}$ ....	<b>5</b>	12.1 Receiving Notification of Documentation Updates .....	<b>14</b>
6.7 Switching Characteristics, $T_A = 25^\circ\text{C}$ .....	<b>5</b>	12.2 Community Resources .....	<b>14</b>
6.8 Switching Characteristics, $T_A = -40^\circ\text{C}$ to $+105^\circ\text{C}$ ....	<b>5</b>	12.3 Trademarks .....	<b>14</b>
6.9 Typical Characteristics .....	<b>6</b>	12.4 Electrostatic Discharge Caution .....	<b>14</b>
<b>7 Parameter Measurement Information</b> .....	<b>9</b>	12.5 Glossary .....	<b>14</b>
<b>8 Detailed Description</b> .....	<b>10</b>	<b>13 Mechanical, Packaging, and Orderable Information</b> .....	<b>14</b>
8.1 Overview .....	<b>10</b>		

## 4 Revision History

Changes from Revision A (September 2014) to Revision B	Page
• Deleted Hammer Drivers from <i>Applications</i> .....	<b>1</b>
• Updated <i>Pin Functions</i> table .....	<b>3</b>
• Deleted Package Thermal Information from <i>Absolute Maximum Ratings</i> .....	<b>4</b>
• Moved Storage temperature, $T_{stg}$ to <i>Absolute Maximum Ratings</i> .....	<b>4</b>
• Deleted $V_I$ from <i>Recommended Operating Conditions</i> .....	<b>4</b>
• Updated <i>Thermal Information</i> table .....	<b>4</b>
• Moved Operating free-air temperature, $T_A$ to <i>Recommended Operating Conditions</i> .....	<b>4</b>
• Deleted <i>Output Current vs Input Current</i> graph from <i>Typical Characteristics</i> section .....	<b>6</b>
• Added $h_{FE}$ vs $I_{OUT}$ to <i>Typical Characteristics</i> section .....	<b>6</b>
• Deleted <i>Thermal Information</i> graphs section and updated <i>Typical Characteristics</i> section with new thermal graphs <a href="#">Figure 6</a> through <a href="#">Figure 14</a> .....	<b>6</b>
• Added <i>Receiving Notification of Documentation Updates</i> section and <i>Community Resources</i> section .....	<b>14</b>

Changes from Original (June 2014) to Revision A	Page
• Initial release of full version. ....	<b>1</b>
• Added Pin Functions table .....	<b>3</b>
• Added Thermal Information table .....	<b>4</b>

## 5 Pin Configuration and Functions

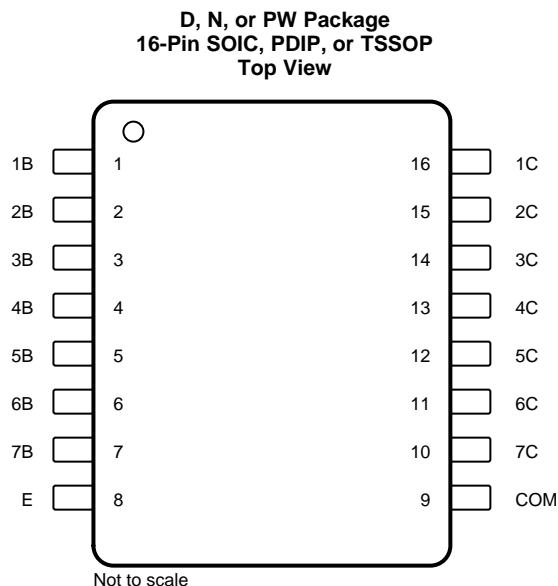

### Pin Functions

PIN		I/O <sup>(1)</sup>	DESCRIPTION
NAME	NO.		
1B	1	I	Channel 1 through 7 darlington base input
2B	2		
3B	3		
4B	4		
5B	5		
6B	6		
7B	7		
1C	16	O	Channel 1 through 7 darlington collector output
2C	15		
3C	14		
4C	13		
5C	12		
6C	11		
7C	10		
COM	9	—	Common cathode node for flyback diodes (required for inductive loads)
E	8	—	Common Emmitter shared by all channels (typically tied to ground)

(1) I = Input, O = Output

## 6 Specifications

### 6.1 Absolute Maximum Ratings

 at 25°C free-air temperature (unless otherwise noted)<sup>(1)</sup>

	MIN	MAX	UNIT
V <sub>CC</sub> Collector-emitter voltage		50	V
Clamp diode reverse voltage <sup>(2)</sup>		50	V
V <sub>I</sub> Input voltage <sup>(2)</sup>		30	V
Peak collector current <sup>(3)(4)</sup>		500	mA
I <sub>OK</sub> Output clamp current		500	mA
Total emitter-terminal current		–2.5	A
T <sub>J</sub> Operating virtual junction temperature		150	°C
T <sub>stg</sub> Storage temperature	–65	150	°C

- (1) Stresses beyond those listed under *Absolute Maximum Ratings* may cause permanent damage to the device. These are stress ratings only, which do not imply functional operation of the device at these or any other conditions beyond those indicated under *Recommended Operating Conditions*. Exposure to absolute-maximum-rated conditions for extended periods may affect device reliability.
- (2) All voltage values are with respect to the emitter/substrate terminal E, unless otherwise noted.
- (3) Maximum power dissipation is a function of T<sub>J</sub>(max), θ<sub>JA</sub>, and T<sub>A</sub>. The maximum allowable power dissipation at any allowable ambient temperature is P<sub>D</sub> = (T<sub>J</sub>(max) – T<sub>A</sub>)/θ<sub>JA</sub>. Operating at the absolute maximum T<sub>J</sub> of 150°C can affect reliability.
- (4) The package thermal impedance is calculated in accordance with JESD 51-7.

### 6.2 ESD Ratings

	VALUE	UNIT
V <sub>(ESD)</sub> Electrostatic discharge	Human body model (HBM), per ANSI/ESDA/JEDEC JS-001 <sup>(1)</sup>	2000
	Charged device model (CDM), per JEDEC specification JESD22-C101 <sup>(2)</sup>	500

- (1) JEDEC document JEP155 states that 500-V HBM allows safe manufacturing with a standard ESD control process.
- (2) JEDEC document JEP157 states that 250-V CDM allows safe manufacturing with a standard ESD control process.

### 6.3 Recommended Operating Conditions

over operating free-air temperature range (unless otherwise noted)

	MIN	MAX	UNIT
V <sub>CC</sub> Supply Voltage	0	50	V
T <sub>A</sub> Operating free-air temperature	–40	105	°C
T <sub>J</sub> Junction Temperature	–40	125	°C

### 6.4 Thermal Information

THERMAL METRIC <sup>(1)</sup>	ULN2003B			UNIT
	PW (TSSOP)	D (SOIC)	N (PDIP)	
	16 PINS	16 PINS	16 PINS	
R <sub>θJA</sub> Junction-to-ambient thermal resistance	105.5	81.2	49.6	°C/W
R <sub>θJC(top)</sub> Junction-to-case (top) thermal resistance	38.3	40	36.2	°C/W
R <sub>θJB</sub> Junction-to-board thermal resistance	50.9	38.6	29.2	°C/W
ψ <sub>JT</sub> Junction-to-top characterization parameter	4.1	10.5	20.2	°C/W
ψ <sub>JB</sub> Junction-to-board characterization parameter	50.3	38.3	29.5	°C/W

- (1) For more information about traditional and new thermal metrics, see the [Semiconductor and IC Package Thermal Metrics](#) application report.

## 6.5 Electrical Characteristics, $T_A = 25^\circ\text{C}$

PARAMETER		TEST FIGURE	TEST CONDITIONS		MIN	TYP	MAX	UNIT
$V_{I(on)}$	On-state input voltage	Figure 19	$V_{CE} = 2\text{ V}$	$I_C = 200\text{ mA}$			2.4	V
				$I_C = 250\text{ mA}$			2.7	
				$I_C = 300\text{ mA}$			3	
$V_{CE(sat)}$	Collector-emitter saturation voltage	Figure 18	$I_I = 250\text{ }\mu\text{A}$ ,	$I_C = 100\text{ mA}$		0.9	1.1	V
			$I_I = 350\text{ }\mu\text{A}$ ,	$I_C = 200\text{ mA}$		1	1.3	
			$I_I = 500\text{ }\mu\text{A}$ ,	$I_C = 350\text{ mA}$		1.2	1.6	
$I_{CEX}$	Collector cutoff current	Figure 15	$V_{CE} = 50\text{ V}$ ,	$I_I = 0$			10	$\mu\text{A}$
$V_F$	Clamp forward voltage	Figure 21	$I_F = 350\text{ mA}$			1.7	2	V
$I_{I(off)}$	Off-state input current	Figure 16	$V_{CE} = 50\text{ V}$ ,	$I_C = 500\text{ }\mu\text{A}$	50	65		$\mu\text{A}$
$I_I$	Input current	Figure 17	$V_I = 3.85\text{ V}$			0.93	1.35	mA
$I_R$	Clamp reverse current	Figure 20	$V_R = 50\text{ V}$				50	$\mu\text{A}$
$C_i$	Input capacitance		$V_I = 0$ ,	$f = 1\text{ MHz}$		15	25	pF

## 6.6 Electrical Characteristics, $T_A = -40^\circ\text{C}$ to $+105^\circ\text{C}$

PARAMETER		TEST FIGURE	TEST CONDITIONS		MIN	TYP	MAX	UNIT
$V_{I(on)}$	On-state input voltage	Figure 19	$V_{CE} = 2\text{ V}$	$I_C = 200\text{ mA}$			2.7	V
				$I_C = 250\text{ mA}$			2.9	
				$I_C = 300\text{ mA}$			3	
$V_{CE(sat)}$	Collector-emitter saturation voltage	Figure 18	$I_I = 250\text{ }\mu\text{A}$ ,	$I_C = 100\text{ mA}$		0.9	1.2	V
			$I_I = 350\text{ }\mu\text{A}$ ,	$I_C = 200\text{ mA}$		1	1.4	
			$I_I = 500\text{ }\mu\text{A}$ ,	$I_C = 350\text{ mA}$		1.2	1.7	
$I_{CEX}$	Collector cutoff current	Figure 15	$V_{CE} = 50\text{ V}$ ,	$I_I = 0$			20	$\mu\text{A}$
$V_F$	Clamp forward voltage	Figure 21	$I_F = 350\text{ mA}$			1.7	2.2	V
$I_{I(off)}$	Off-state input current	Figure 16	$V_{CE} = 50\text{ V}$ ,	$I_C = 500\text{ }\mu\text{A}$	30	65		$\mu\text{A}$
$I_I$	Input current	Figure 17	$V_I = 3.85\text{ V}$			0.93	1.35	mA
$I_R$	Clamp reverse current	Figure 20	$V_R = 50\text{ V}$				100	$\mu\text{A}$
$C_i$	Input capacitance		$V_I = 0$ ,	$f = 1\text{ MHz}$		15	25	pF

## 6.7 Switching Characteristics, $T_A = 25^\circ\text{C}$

PARAMETER		TEST CONDITIONS		MIN	TYP	MAX	UNIT
$t_{PLH}$	Propagation delay time, low- to high-level output				0.25	1	$\mu\text{s}$
$t_{PHL}$	Propagation delay time, high- to low-level output				0.25	1	$\mu\text{s}$
$V_{OH}$	High-level output voltage after switching	$V_S = 50\text{ V}$ ,	$I_O \approx 300\text{ mA}$	$V_S - 20$			mV

## 6.8 Switching Characteristics, $T_A = -40^\circ\text{C}$ to $+105^\circ\text{C}$

PARAMETER		TEST CONDITIONS		MIN	TYP	MAX	UNIT
$t_{PLH}$	Propagation delay time, low- to high-level output				1	10	$\mu\text{s}$
$t_{PHL}$	Propagation delay time, high- to low-level output				1	10	$\mu\text{s}$
$V_{OH}$	High-level output voltage after switching	$V_S = 50\text{ V}$ ,	$I_O \approx 300\text{ mA}$	$V_S - 50$			mV

### 6.9 Typical Characteristics

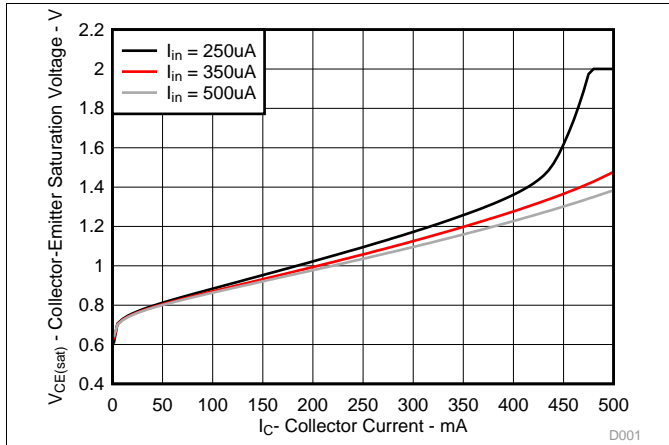

Figure 1. Collector-Emitter Saturation Voltage vs Collector Current (One Darlington)

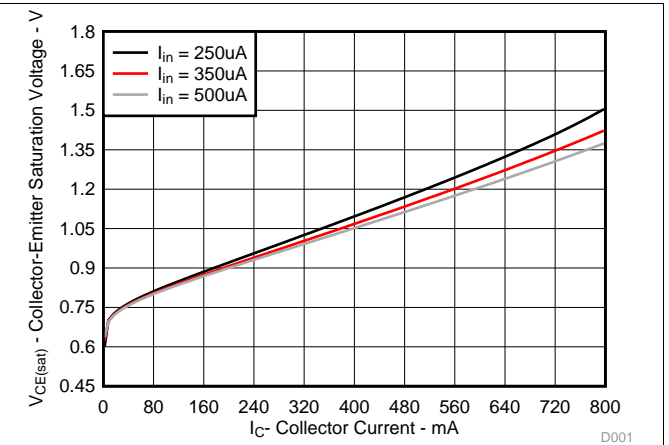

Figure 2. Collector-Emitter Saturation Voltage vs Total Collector Current (Two Darlings in Parallel)

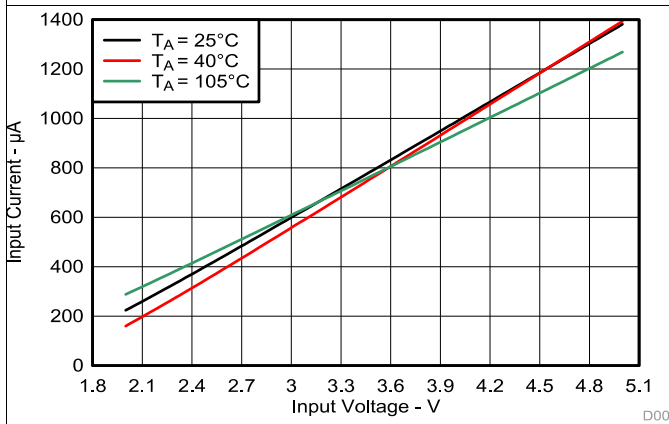

Figure 3. Input Current vs Input Voltage

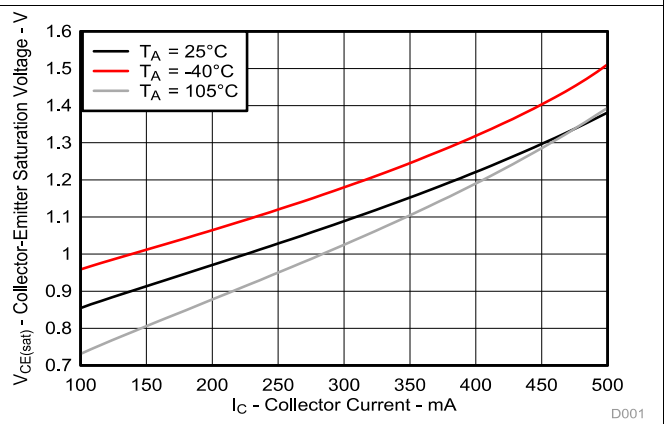

Figure 4. Collector-Emitter Saturation Voltage vs Collector Current

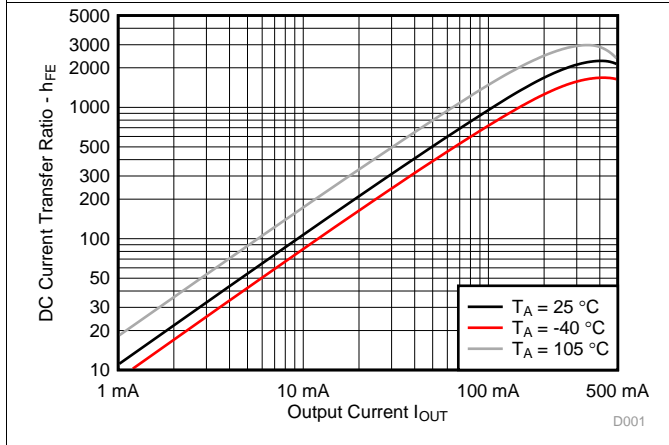

Figure 5.  $h_{FE}$  vs  $I_{OUT}$

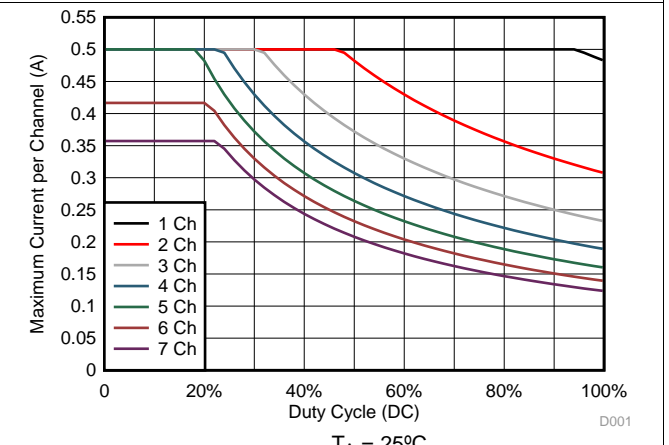

Figure 6. D Package Maximum Collector Current vs Duty Cycle

Typical Characteristics (continued)

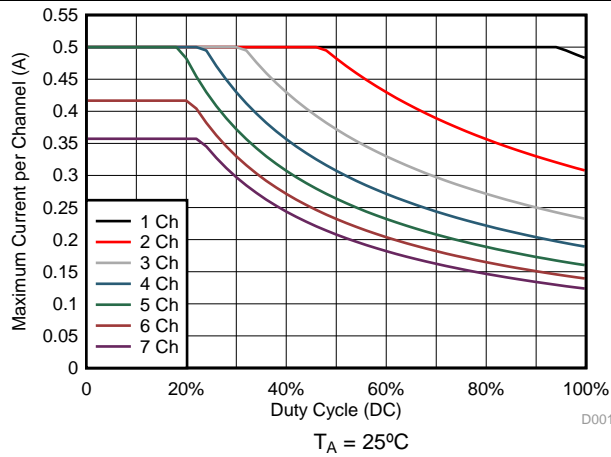

Figure 7. PW Package Maximum Collector Current vs Duty Cycle

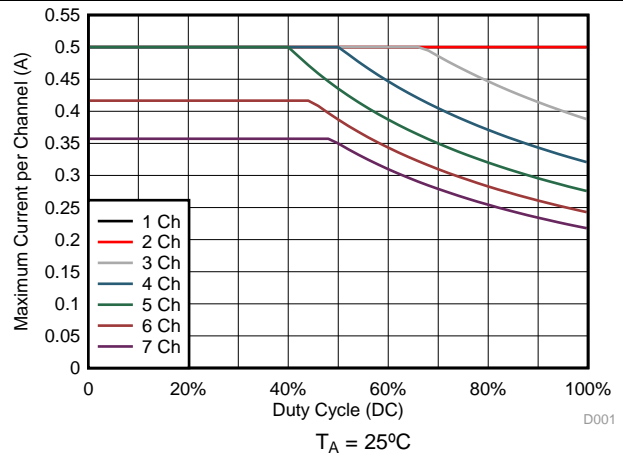

Figure 8. N Package Maximum Collector Current vs Duty Cycle

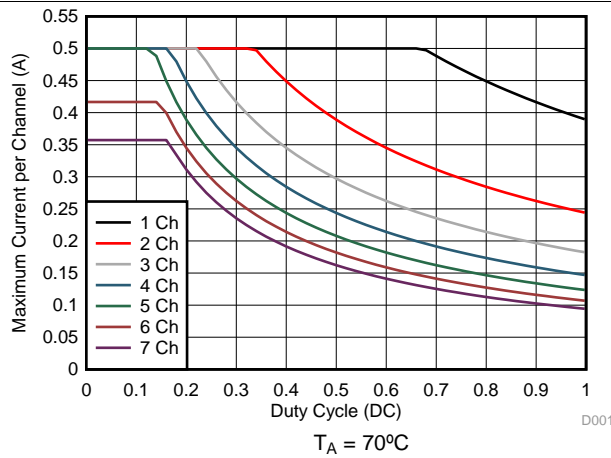

Figure 9. D Package Maximum Collector Current vs Duty Cycle

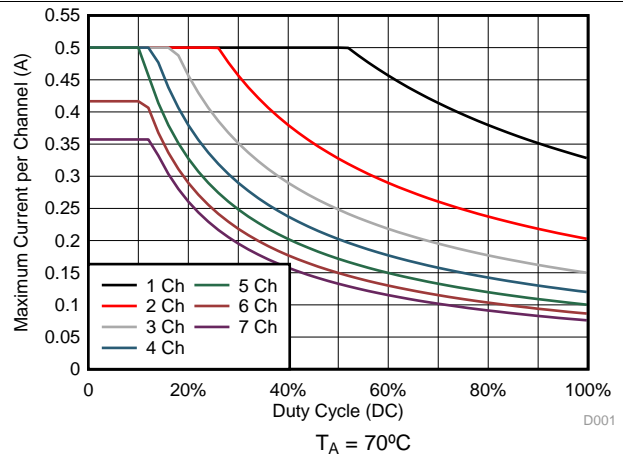

Figure 10. PW Package Maximum Collector Current vs Duty Cycle

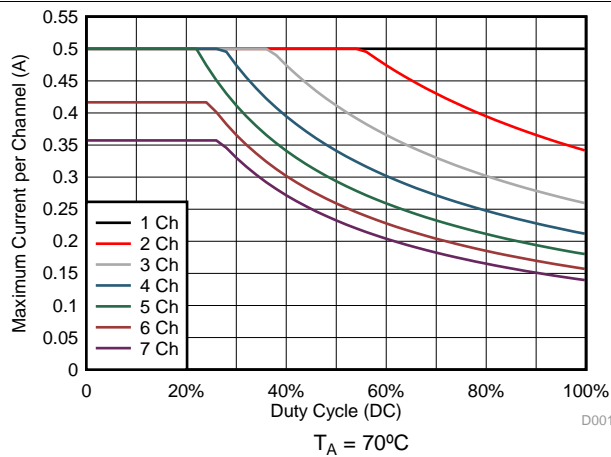

Figure 11. N Package Maximum Collector Current vs Duty Cycle

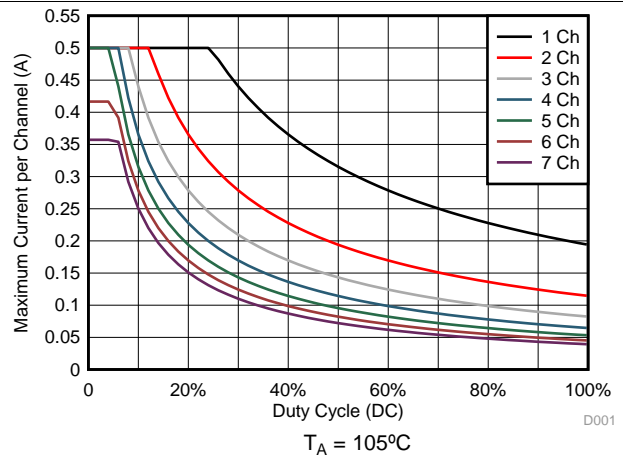
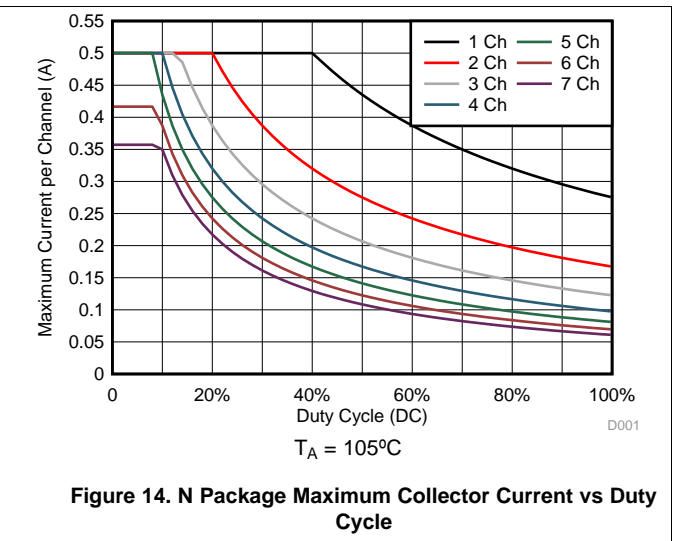
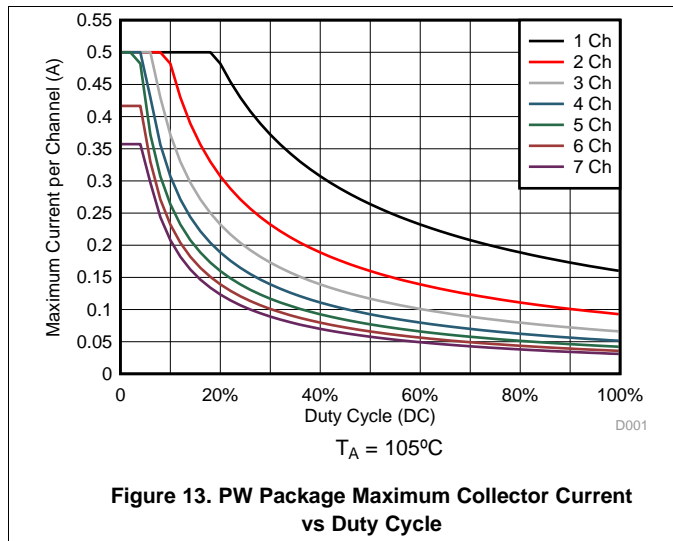

Figure 12. D Package Maximum Collector Current vs Duty Cycle

**Typical Characteristics (continued)**





## 7 Parameter Measurement Information

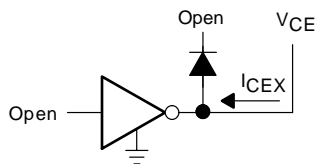

**Figure 15.  $I_{CEX}$  Test Circuit**

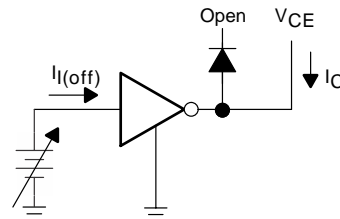

**Figure 16.  $I_{I(off)}$  Test Circuit**

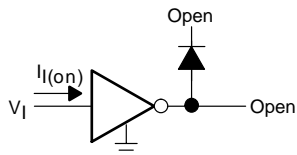

**Figure 17.  $I_I$  Test Circuit**

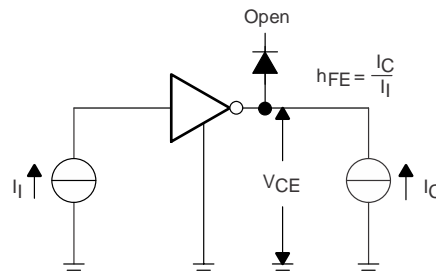

**Figure 18.  $h_{fe}$ ,  $V_{CE(sat)}$  Test Circuit**

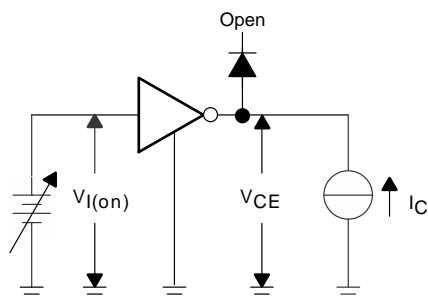

**Figure 19.  $V_{I(on)}$  Test Circuit**

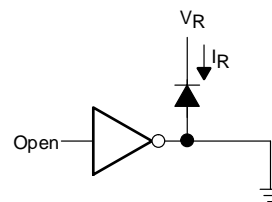

**Figure 20.  $I_R$  Test Circuit**

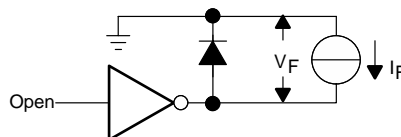

**Figure 21.  $V_F$  Test Circuit**

## 8 Detailed Description

### 8.1 Overview

This standard device has proven ubiquity and versatility across a wide range of applications. This is due to its integration of 7 Darlington transistors that are capable of sinking up to 500 mA and wide GPIO range capability.

The ULN2003B comprises seven high voltage, high current NPN Darlington transistor pairs. All units feature a common emitter and open collector outputs. To maximize their effectiveness, these units contain suppression diodes for inductive loads. The ULN2003B has a series base resistor to each Darlington pair, thus allowing operation directly with TTL or CMOS operating at supply voltages of 5 V or 3.3 V. The ULN2003B offers solutions to a great many interface needs, including solenoids, relays, lamps, small motors, and LEDs. Applications requiring sink currents beyond the capability of a single output may be accommodated by paralleling the outputs.

This device can operate over a wide temperature range ( $-40^{\circ}\text{C}$  to  $+105^{\circ}\text{C}$ ).

### 8.2 Functional Block Diagram

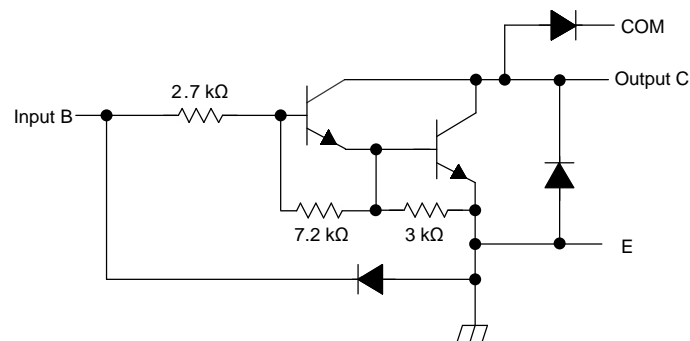

Copyright © 2016, Texas Instruments Incorporated

All resistor values shown are nominal.

**Figure 22. Schematic (Each Driver)**

### 8.3 Feature Description

Each channel of ULN2003B consists of Darlington connected NPN transistors. This connection creates the effect of a single transistor with a very high current gain. This beta can be high at certain currents see [Figure 5](#).

The GPIO voltage is converted to base current through the 2.7-kΩ resistor connected between the input and base of the pre-driver Darlington NPN. The 7.2-kΩ and 3-kΩ resistors connected between the base and emitter of each respective NPN act as pull-downs and suppress the amount of leakage that may occur from the input.

The diodes connected between the output and COM pin is used to suppress the kick-back voltage from an inductive load that is excited when the NPN drivers are turned off (stop sinking) and the stored energy in the coils causes a reverse current to flow into the coil supply through the kick-back diode.

In normal operation the diodes on base and collector pins to emitter will be reversed biased. If these diodes are forward biased, internal parasitic NPN transistors will draw (a nearly equal) current from other (nearby) device pins.

## 8.4 Device Functional Modes

### 8.4.1 Inductive Load Drive

When the COM pin is tied to the coil supply voltage, ULN2003B is able to drive inductive loads and suppress the kick-back voltage through the internal free wheeling diodes.

### 8.4.2 Resistive Load Drive

When driving a resistive load, a pull-up resistor is needed in order for ULN2003B to sink current and for there to be a logic high level. The COM pin can be left floating for these applications.

## 9 Application and Implementation

### NOTE

Information in the following applications sections is not part of the TI component specification, and TI does not warrant its accuracy or completeness. TI's customers are responsible for determining suitability of components for their purposes. Customers should validate and test their design implementation to confirm system functionality.

### 9.1 Application Information

ULN2003B will typically be used to drive a high voltage and/or current peripheral from an MCU or logic device that cannot tolerate these conditions. The following design is a common application of ULN2003B, driving inductive loads. This includes motors, solenoids and relays. Figure 23 is a typical block diagram representation of this application.

### 9.2 Typical Application

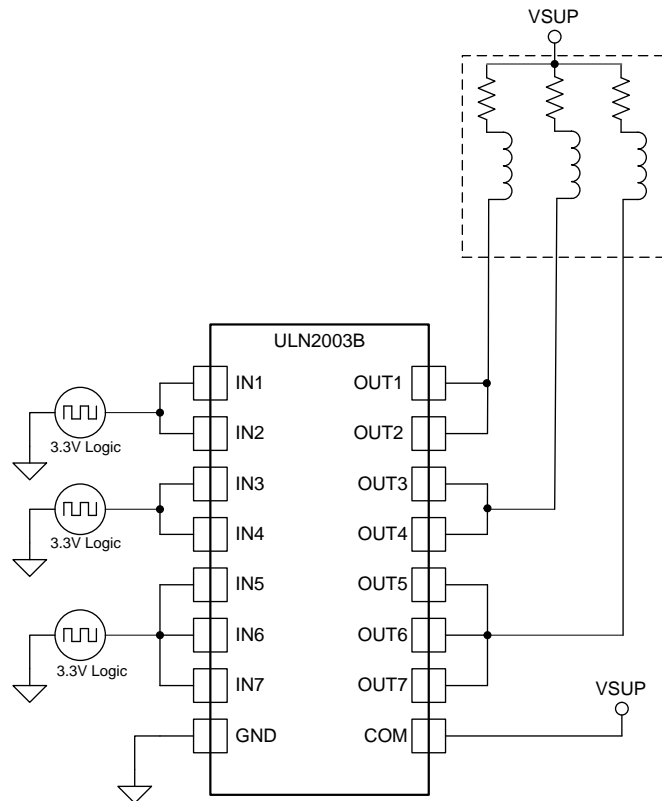

Copyright © 2016, Texas Instruments Incorporated

Figure 23. ULN2003B as Inductive Load Driver

## Typical Application (continued)

### 9.2.1 Design Requirements

For this design example, use the parameters listed in [Table 1](#) as the input parameters.

**Table 1. Design Parameters**

DESIGN PARAMETER <sup>(1)</sup>	EXAMPLE VALUE
GPIO Voltage	3.3 V or 5 V
Coil Supply Voltage	12 V to 48 V
Number of Channels	7
Output Current (R <sub>COIL</sub> )	20 mA to 300 mA per channel (See <a href="#">Figure 5</a> )
Duty Cycle	See <a href="#">Figure 6</a> to <a href="#">Figure 14</a>

(1) These test conditions can not be run simultaneously.

### 9.2.2 Detailed Design Procedure

When using ULN2003B in a coil driving application, determine the following:

- Input Voltage Range
- Temperature Range
- Output and Drive Current
- Power Dissipation

#### 9.2.2.1 Drive Current

The coil current is determined by the coil voltage (V<sub>SUP</sub>), coil resistance and output low voltage (V<sub>OL</sub> or V<sub>CE(SAT)</sub>).

$$I_{\text{COIL}} = (V_{\text{SUP}} - V_{\text{CE(SAT)}}) / R_{\text{COIL}} \quad (1)$$

#### 9.2.2.2 Output Low Voltage

The output low voltage (V<sub>OL</sub>) is the same thing as V<sub>CE(SAT)</sub> and can be determined by, [Figure 1](#), [Figure 2](#), or [Figure 4](#).

#### 9.2.2.3 Power Dissipation and Temperature

The number of coils driven is dependent on the coil current and on-chip power dissipation. The number of coils driven can be determined by [Figure 6](#) or [Figure 7](#).

For a more accurate determination of number of coils possible, use [Equation 2](#) to calculate ULN2003B on-chip power dissipation P<sub>D</sub>:

$$P_D = \sum_{i=1}^N V_{\text{OL}_i} \times I_{\text{L}_i}$$

where

- N is the number of channels active together.
- V<sub>OL<sub>i</sub></sub> is the OUT<sub>i</sub> pin voltage for the load current I<sub>L<sub>i</sub></sub>. This is the same as V<sub>CE(SAT)</sub> (2)

In order to guarantee reliability of ULN2003B and the system the on-chip power dissipation must be lower than or equal to the maximum allowable power dissipation (PD<sub>(MAX)</sub>) dictated by [Equation 3](#).

$$PD_{\text{(MAX)}} = \frac{(T_{\text{J(MAX)}} - T_{\text{A}})}{\theta_{\text{JA}}}$$

where

- T<sub>J(MAX)</sub> is the target maximum junction temperature.
- T<sub>A</sub> is the operating ambient temperature.
- θ<sub>JA</sub> is the package junction to ambient thermal resistance. (3)

TI recommends to limit ULN2003B IC's die junction temperature to less than 125°C. The IC junction temperature is directly proportional to the on-chip power dissipation.

### 9.2.3 Application Curves

The following curves were generated with ULN2003B driving an OMRON G5NB relay –  $V_{in} = 5.0V$ ;  $V_{sup} = 12 V$  and  $R_{COIL} = 2.8 k\Omega$

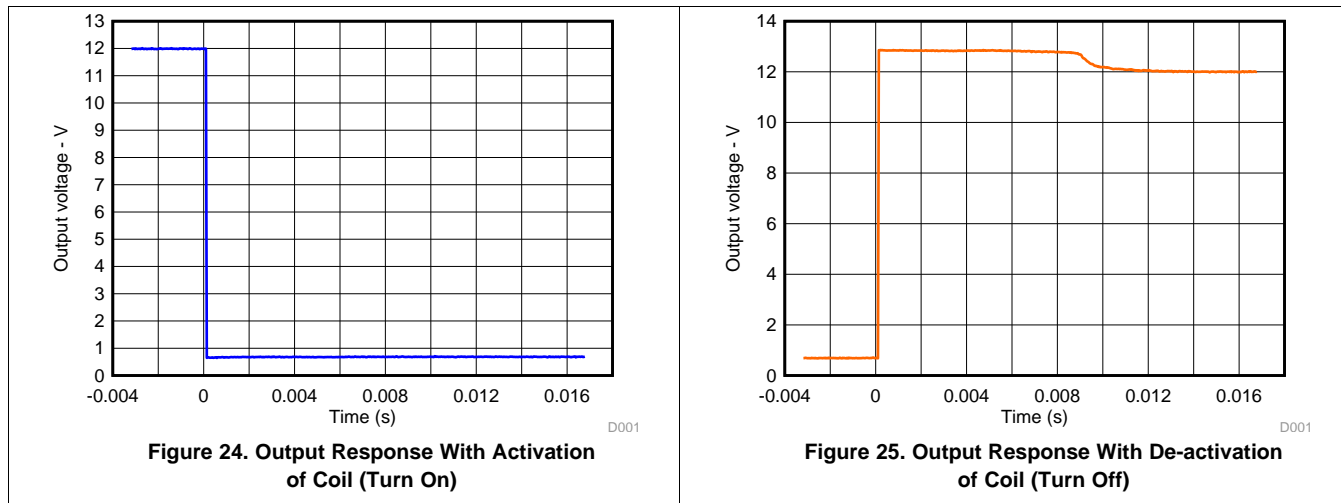

## 10 Power Supply Recommendations

This part does not need a power supply; however, the COM pin is typically tied to the system power supply. When this is the case, it is very important to make sure that the output voltage does not exceed the COM pin voltage. This will heavily forward bias the fly-back diodes and cause a large current to flow into COM, potentially damaging the on-chip metal or over-heating the part.

## 11 Layout

### 11.1 Layout Guidelines

Thin traces can be used on the input due to the low current logic that is typically used to drive UNL2003B. Care must be taken to separate the input channels as much as possible, as to eliminate cross-talk. Thick traces are recommended for the output, in order to drive whatever high currents that may be needed. Wire thickness can be determined by the trace material's current density and desired drive current.

Since all of the channels currents return to a common emitter, it is best to size that trace width to be very wide. Some applications require up to 2.5 A.

### 11.2 Layout Example

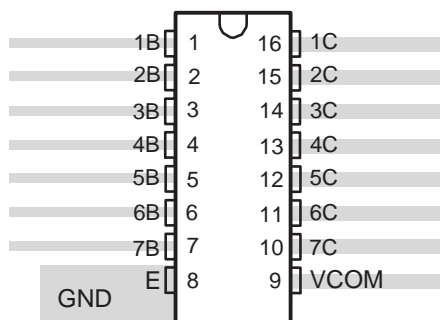

**Figure 26. Package Layout**

## 12 Device and Documentation Support

### 12.1 Receiving Notification of Documentation Updates

To receive notification of documentation updates, navigate to the device product folder on ti.com. In the upper right corner, click on *Alert me* to register and receive a weekly digest of any product information that has changed. For change details, review the revision history included in any revised document.

### 12.2 Community Resources

The following links connect to TI community resources. Linked contents are provided "AS IS" by the respective contributors. They do not constitute TI specifications and do not necessarily reflect TI's views; see TI's [Terms of Use](#).

**TI E2E™ Online Community** *TI's Engineer-to-Engineer (E2E) Community*. Created to foster collaboration among engineers. At e2e.ti.com, you can ask questions, share knowledge, explore ideas and help solve problems with fellow engineers.

**Design Support** *TI's Design Support* Quickly find helpful E2E forums along with design support tools and contact information for technical support.

### 12.3 Trademarks

E2E is a trademark of Texas Instruments.  
All other trademarks are the property of their respective owners.

### 12.4 Electrostatic Discharge Caution



This integrated circuit can be damaged by ESD. Texas Instruments recommends that all integrated circuits be handled with appropriate precautions. Failure to observe proper handling and installation procedures can cause damage.

ESD damage can range from subtle performance degradation to complete device failure. Precision integrated circuits may be more susceptible to damage because very small parametric changes could cause the device not to meet its published specifications.

### 12.5 Glossary

[SLYZ022](#) — *TI Glossary*.

This glossary lists and explains terms, acronyms, and definitions.

## 13 Mechanical, Packaging, and Orderable Information

The following pages include mechanical, packaging, and orderable information. This information is the most current data available for the designated devices. This data is subject to change without notice and revision of this document. For browser-based versions of this data sheet, refer to the left-hand navigation.

**PACKAGING INFORMATION**

Orderable Device	Status (1)	Package Type	Package Drawing	Pins	Package Qty	Eco Plan (2)	Lead finish/ Ball material (6)	MSL Peak Temp (3)	Op Temp (°C)	Device Marking (4/5)	Samples
ULN2003BDR	ACTIVE	SOIC	D	16	2500	RoHS & Green	NIPDAU   SN	Level-1-260C-UNLIM	-40 to 105	ULN2003B	<a href="#">Samples</a>
ULN2003BN	ACTIVE	PDIP	N	16	25	RoHS & Non-Green	SN	N / A for Pkg Type	-40 to 105	ULN2003BN	<a href="#">Samples</a>
ULN2003BPWR	ACTIVE	TSSOP	PW	16	2000	RoHS & Green	NIPDAU   SN	Level-1-260C-UNLIM	-40 to 105	UN2003B	<a href="#">Samples</a>

(1) The marketing status values are defined as follows:

**ACTIVE:** Product device recommended for new designs.

**LIFEBUY:** TI has announced that the device will be discontinued, and a lifetime-buy period is in effect.

**NRND:** Not recommended for new designs. Device is in production to support existing customers, but TI does not recommend using this part in a new design.

**PREVIEW:** Device has been announced but is not in production. Samples may or may not be available.

**OBSOLETE:** TI has discontinued the production of the device.

(2) **RoHS:** TI defines "RoHS" to mean semiconductor products that are compliant with the current EU RoHS requirements for all 10 RoHS substances, including the requirement that RoHS substance do not exceed 0.1% by weight in homogeneous materials. Where designed to be soldered at high temperatures, "RoHS" products are suitable for use in specified lead-free processes. TI may reference these types of products as "Pb-Free".

**RoHS Exempt:** TI defines "RoHS Exempt" to mean products that contain lead but are compliant with EU RoHS pursuant to a specific EU RoHS exemption.

**Green:** TI defines "Green" to mean the content of Chlorine (Cl) and Bromine (Br) based flame retardants meet JS709B low halogen requirements of <=1000ppm threshold. Antimony trioxide based flame retardants must also meet the <=1000ppm threshold requirement.

(3) MSL, Peak Temp. - The Moisture Sensitivity Level rating according to the JEDEC industry standard classifications, and peak solder temperature.

(4) There may be additional marking, which relates to the logo, the lot trace code information, or the environmental category on the device.

(5) Multiple Device Markings will be inside parentheses. Only one Device Marking contained in parentheses and separated by a "~" will appear on a device. If a line is indented then it is a continuation of the previous line and the two combined represent the entire Device Marking for that device.

(6) Lead finish/Ball material - Orderable Devices may have multiple material finish options. Finish options are separated by a vertical ruled line. Lead finish/Ball material values may wrap to two lines if the finish value exceeds the maximum column width.

**Important Information and Disclaimer:**The information provided on this page represents TI's knowledge and belief as of the date that it is provided. TI bases its knowledge and belief on information provided by third parties, and makes no representation or warranty as to the accuracy of such information. Efforts are underway to better integrate information from third parties. TI has taken and continues to take reasonable steps to provide representative and accurate information but may not have conducted destructive testing or chemical analysis on incoming materials and chemicals. TI and TI suppliers consider certain information to be proprietary, and thus CAS numbers and other limited information may not be available for release.

In no event shall TI's liability arising out of such information exceed the total purchase price of the TI part(s) at issue in this document sold by TI to Customer on an annual basis.



**TAPE AND REEL INFORMATION**

**QUADRANT ASSIGNMENTS FOR PIN 1 ORIENTATION IN TAPE**

\*All dimensions are nominal

Device	Package Type	Package Drawing	Pins	SPQ	Reel Diameter (mm)	Reel Width W1 (mm)	A0 (mm)	B0 (mm)	K0 (mm)	P1 (mm)	W (mm)	Pin1 Quadrant
ULN2003BDR	SOIC	D	16	2500	330.0	16.8	6.5	10.3	2.1	8.0	16.0	Q1
ULN2003BDR	SOIC	D	16	2500	330.0	16.4	6.5	10.3	2.1	8.0	16.0	Q1
ULN2003BPWR	TSSOP	PW	16	2000	330.0	12.4	6.9	5.6	1.6	8.0	12.0	Q1
ULN2003BPWR	TSSOP	PW	16	2000	330.0	12.4	6.9	5.6	1.6	8.0	12.0	Q1

**TAPE AND REEL BOX DIMENSIONS**

\*All dimensions are nominal

Device	Package Type	Package Drawing	Pins	SPQ	Length (mm)	Width (mm)	Height (mm)
ULN2003BDR	SOIC	D	16	2500	364.0	364.0	27.0
ULN2003BDR	SOIC	D	16	2500	367.0	367.0	38.0
ULN2003BPWR	TSSOP	PW	16	2000	853.0	449.0	35.0
ULN2003BPWR	TSSOP	PW	16	2000	364.0	364.0	27.0

N (R-PDIP-T\*\*)

PLASTIC DUAL-IN-LINE PACKAGE

16 PINS SHOWN



- NOTES:
- A. All linear dimensions are in inches (millimeters).
  - B. This drawing is subject to change without notice.
  - Falls within JEDEC MS-001, except 18 and 20 pin minimum body length (Dim A).
  - The 20 pin end lead shoulder width is a vendor option, either half or full width.

D (R-PDSO-G16)

PLASTIC SMALL OUTLINE



- NOTES:
- A. All linear dimensions are in inches (millimeters).
  - B. This drawing is subject to change without notice.
  - C. Body length does not include mold flash, protrusions, or gate burrs. Mold flash, protrusions, or gate burrs shall not exceed 0.006 (0,15) each side.
  - D. Body width does not include interlead flash. Interlead flash shall not exceed 0.017 (0,43) each side.
  - E. Reference JEDEC MS-012 variation AC.

D (R-PDSO-G16)

PLASTIC SMALL OUTLINE



- NOTES:
- All linear dimensions are in millimeters.
  - This drawing is subject to change without notice.
  - Publication IPC-7351 is recommended for alternate designs.
  - Laser cutting apertures with trapezoidal walls and also rounding corners will offer better paste release. Customers should contact their board assembly site for stencil design recommendations. Refer to IPC-7525 for other stencil recommendations.
  - Customers should contact their board fabrication site for solder mask tolerances between and around signal pads.



4220204/A 02/2017

NOTES:

1. All linear dimensions are in millimeters. Any dimensions in parenthesis are for reference only. Dimensioning and tolerancing per ASME Y14.5M.
2. This drawing is subject to change without notice.
3. This dimension does not include mold flash, protrusions, or gate burrs. Mold flash, protrusions, or gate burrs shall not exceed 0.15 mm per side.
4. This dimension does not include interlead flash. Interlead flash shall not exceed 0.25 mm per side.
5. Reference JEDEC registration MO-153.

# EXAMPLE BOARD LAYOUT

PW0016A

TSSOP - 1.2 mm max height

SMALL OUTLINE PACKAGE



LAND PATTERN EXAMPLE  
EXPOSED METAL SHOWN  
SCALE: 10X



SOLDER MASK DETAILS

4220204/A 02/2017

NOTES: (continued)

- 6. Publication IPC-7351 may have alternate designs.
- 7. Solder mask tolerances between and around signal pads can vary based on board fabrication site.

# EXAMPLE STENCIL DESIGN

PW0016A

TSSOP - 1.2 mm max height

SMALL OUTLINE PACKAGE



SOLDER PASTE EXAMPLE  
BASED ON 0.125 mm THICK STENCIL  
SCALE: 10X

4220204/A 02/2017

NOTES: (continued)

8. Laser cutting apertures with trapezoidal walls and rounded corners may offer better paste release. IPC-7525 may have alternate design recommendations.
9. Board assembly site may have different recommendations for stencil design.



## IMPORTANT NOTICE AND DISCLAIMER

TI PROVIDES TECHNICAL AND RELIABILITY DATA (INCLUDING DATASHEETS), DESIGN RESOURCES (INCLUDING REFERENCE DESIGNS), APPLICATION OR OTHER DESIGN ADVICE, WEB TOOLS, SAFETY INFORMATION, AND OTHER RESOURCES "AS IS" AND WITH ALL FAULTS, AND DISCLAIMS ALL WARRANTIES, EXPRESS AND IMPLIED, INCLUDING WITHOUT LIMITATION ANY IMPLIED WARRANTIES OF MERCHANTABILITY, FITNESS FOR A PARTICULAR PURPOSE OR NON-INFRINGEMENT OF THIRD PARTY INTELLECTUAL PROPERTY RIGHTS.

These resources are intended for skilled developers designing with TI products. You are solely responsible for (1) selecting the appropriate TI products for your application, (2) designing, validating and testing your application, and (3) ensuring your application meets applicable standards, and any other safety, security, or other requirements. These resources are subject to change without notice. TI grants you permission to use these resources only for development of an application that uses the TI products described in the resource. Other reproduction and display of these resources is prohibited. No license is granted to any other TI intellectual property right or to any third party intellectual property right. TI disclaims responsibility for, and you will fully indemnify TI and its representatives against, any claims, damages, costs, losses, and liabilities arising out of your use of these resources.

TI's products are provided subject to TI's Terms of Sale ([www.ti.com/legal/termsofsale.html](http://www.ti.com/legal/termsofsale.html)) or other applicable terms available either on [ti.com](http://ti.com) or provided in conjunction with such TI products. TI's provision of these resources does not expand or otherwise alter TI's applicable warranties or warranty disclaimers for TI products.

Mailing Address: Texas Instruments, Post Office Box 655303, Dallas, Texas 75265  
Copyright © 2020, Texas Instruments Incorporated