



SGM8905

Capless 2Vrms to 3Vrms Line Driver with Adjustable Gain

GENERAL DESCRIPTION

The SGM8905 is a 2Vrms to 3Vrms pop/click-free stereo line driver designed to allow the removal of the output DC-blocking capacitors for reduced component count and cost. The device is ideal for single supply electronics where size and cost are critical design parameters.

The SGM8905 is capable of driving 3Vrms into a 2.5k Ω load with 5V supply voltage. The device has single input and uses external gain setting resistors that supports a gain range of $\pm 1V/V$ to $\pm 10V/V$. The use of external gain resistors also allows the implementation of a 2nd-order low pass filter to compliment DAC's and SOC converters. The SGM8905 has build-in shutdown control for pop/click-free on/off control.

Using the SGM8905 in audio products can reduce component count compared to traditional methods of generating a 3Vrms output. The SGM8905 doesn't require a power supply greater than 5V to generate an 8.5V_{PP} output, nor does the device require a split rail power supply. The SGM8905 integrates a charge pump to generate a negative supply rail that provides a clean, pop/click-free ground-biased 3Vrms output.

The SGM8905 is available in Green MSOP-10 (Exposed Pad) package. It operates over an ambient temperature range of -40°C to +85°C.

FEATURES

- **Capless Structure**
 - Eliminates Pop/Clicks
 - Eliminates Output DC-Blocking Capacitors
 - Provides Flat Frequency Response from DC to 20kHz
- **Low Noise and THD**
 - Typical SNR = 114dB
 - Typical V_N = 5.4 μ Vrms
 - Typical THD+N = 0.001% (f = 1kHz)
- **2Vrms Output Voltage into 2.5k Ω Load with 3.3V Supply Voltage**
- **3Vrms Output Voltage into 2.5k Ω Load with 5V Supply Voltage**
- **-40°C to +85°C Operating Temperature Range**
- **Available in the Green MSOP-10 (Exposed Pad) Package**

APPLICATIONS

Set-Top Box
LCD TV
Blue-Ray DVD-Players
Home Theater in a Box

PACKAGE/ORDERING INFORMATION

MODEL	PACKAGE DESCRIPTION	SPECIFIED TEMPERATURE RANGE	ORDERING NUMBER	PACKAGE MARKING	PACKING OPTION
SGM8905	MSOP-10 (Exposed Pad)	-40°C to +85°C	SGM8905YPMS10G/TR	SGM8905 YPMS10 XXXXXX	Tape and Reel, 4000

NOTE: XXXXX = Date Code and Vendor Code.

Green (RoHS & HSF): SG Micro Corp defines "Green" to mean Pb-Free (RoHS compatible) and free of halogen substances. If you have additional comments or questions, please contact your SGMICRO representative directly.

ABSOLUTE MAXIMUM RATINGS

Supply Voltage..... -0.3V to 6V
 Input Voltage..... $V_{SS} - 0.3V$ to $V_{DD} + 0.3V$
 Minimum Load Impedance (R_L)600Ω
 EN to GND.....-0.3V to $V_{DD} + 0.3V$
 Junction Temperature+150°C
 Storage Temperature Range.....-65°C to +150°C
 Lead Temperature (Soldering, 10s)+260°C
 ESD Susceptibility
 HBM..... 6000V
 MM..... 300V
 CDM 1000V

RECOMMENDED OPERATING CONDITIONS

Supply Voltage Range3V to 5.5V
 Operating Temperature Range-40°C to +85°C

OVERSTRESS CAUTION

Stresses beyond those listed may cause permanent damage to the device. Functional operation of the device at these or any other conditions beyond those indicated in the operational section of the specification is not implied. Exposure to absolute maximum rating conditions for extended periods may affect reliability.

ESD SENSITIVITY CAUTION

This integrated circuit can be damaged by ESD if you don't pay attention to ESD protection. SGMICRO recommends that all integrated circuits be handled with appropriate precautions. Failure to observe proper handling and installation procedures can cause damage. ESD damage can range from subtle performance degradation to complete device failure. Precision integrated circuits may be more susceptible to damage because very small parametric changes could cause the device not to meet its published specifications.

DISCLAIMER

SG Micro Corp reserves the right to make any change in circuit design, specification or other related things if necessary without notice at any time.

TYPICAL OPERATION CIRCUIT

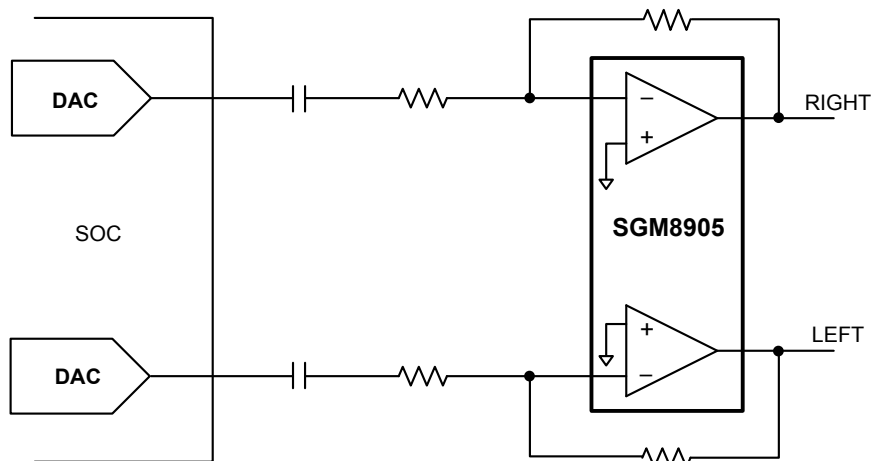

PIN CONFIGURATION

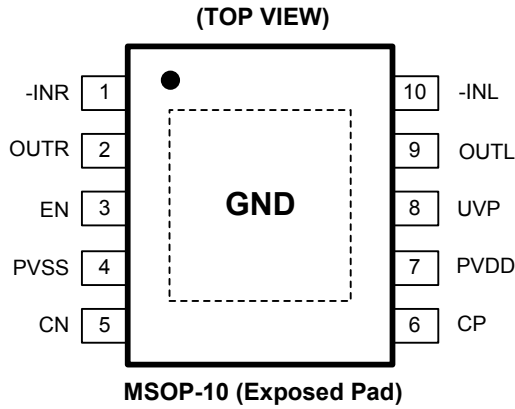

PIN DESCRIPTION

PIN	NAME	FUNCTION
1	-INR	Right Channel OPAMP Negative Input.
2	OUTR	Right Channel OPAMP Output.
3	EN	Enable Input. Active high.
4	PVSS	Negative Supply Voltage Output.
5	CN	Charge Pump Flying Capacitor Negative Terminal.
6	CP	Charge Pump Flying Capacitor Positive Terminal.
7	PVDD	Positive Supply.
8	UVP	Under-Voltage Protection Input.
9	OUTL	Left Channel OPAMP Output.
10	-INL	Left Channel OPAMP Negative Input.
Exposed Pad	GND	Exposed Paddle. Can only be connected to GND.

ELECTRICAL CHARACTERISTICS

(T_A = +25°C, unless otherwise noted.)

PARAMETER	CONDITIONS	MIN	TYP	MAX	UNITS
ELECTRICAL CHARACTERISTICS					
DC Supply Voltage (V _{DD})		3		5.5	V
Output Offset Voltage (V _{OS})	V _{DD} = 3V to 5V		1	5.5	mV
Power Supply Rejection Ratio (PSRR)	V _{DD} = 3V to 5V		97		dB
High-Level Output Voltage (V _{OH})	V _{DD} = 3.3V, R _L = 2.5kΩ	3.18			V
Low-Level Output Voltage (V _{OL})	V _{DD} = 3.3V, R _L = 2.5kΩ			-3.05	V
High-Level Input Current (EN) (I _{IH})	V _{DD} = 5V, V _I = V _{DD}			1	μA
Low-Level Input Current (EN) (I _{IL})	V _{DD} = 5V, V _I = 0V			1	μA
Supply Current (I _{DD})	V _{DD} = 3.3V, No load, EN = V _{DD}		10.8	14.5	mA
	V _{DD} = 5V, No load, EN = V _{DD}		11.5	15.5	
	Shutdown mode, V _{DD} = 3V to 5V		0.13	0.18	
OPERATING CHARACTERISTICS (V _{DD} = 3.3V, R _L = 2.5kΩ, C _{PUMP} = C _{PVSS} = 1μF, C _{IN} = 10μF, R _{IN} = 10kΩ, R _{FB} = 20kΩ.) ⁽¹⁾					
Output Voltage (Outputs In Phase) (V _O)	THD = 1%, V _{DD} = 3.3V, f = 1kHz	2.05			Vrms
	THD = 1%, V _{DD} = 5V, f = 1kHz	3.05			
	THD = 1%, V _{DD} = 5V, f = 1kHz, R _L = 100kΩ	3.1			
Total Harmonic Distortion Plus Noise (THD+N)	V _O = 2Vrms, f = 1kHz		0.001		%
Crosstalk	V _O = 2Vrms, f = 1kHz		103		dB
Output Current Limit (I _O)	V _{DD} = 3.3V		20		mA
Input Resistor Range (R _{IN})			10		kΩ
Feedback Resistor Range (R _{FB})			20		kΩ
Slew Rate			10		V/μs
Maximum Capacitive Load			220		pF
Noise Output Voltage (V _N)	A-weighted, BW = 20kHz		5.4		μVrms
Signal to Noise Ratio (SNR)	A-weighted, V _O = 2Vrms, BW = 20kHz		114		dB
Unity Gain Bandwidth (G _{BW})			8		MHz
Open-Loop Voltage Gain (A _{VO})			100		dB
Charge Pump Frequency (F _{CP})		310	450	580	kHz
External Under-Voltage Detection (V _{UVP})		1.05	1.13	1.25	V
External Under-Voltage Detection Hysteresis Current (I _{HYS})			4.8		μA
EN PIN					
Input High Voltage (V _{INH})	EN	1.2			V
Input Low Voltage (V _{INL})	EN			0.6	V

NOTE:

1. For C_{PUMP}, C_{PVSS}, C_{IN}, R_{IN} and etc, please refer to the APPLICATION CIRCUIT on page 7.

TYPICAL PERFORMANCE CHARACTERISTICS

T_A = +25°C, R_L = 2.5kΩ, C_{PUMP} = C_{PVSS} = 1μF, C_{IN} = 10μF, R_{IN} = 10kΩ, R_{FB} = 20kΩ, unless otherwise noted.

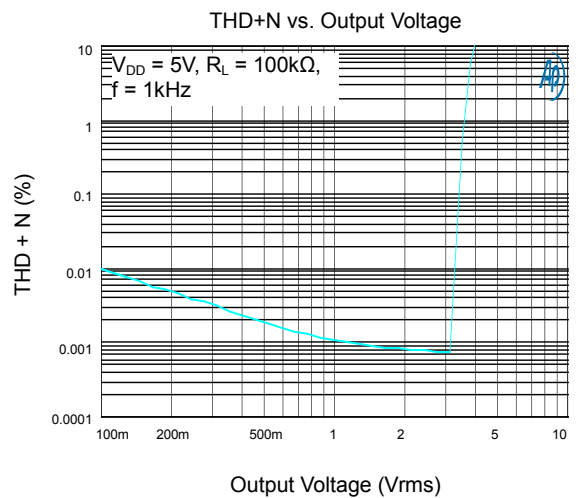
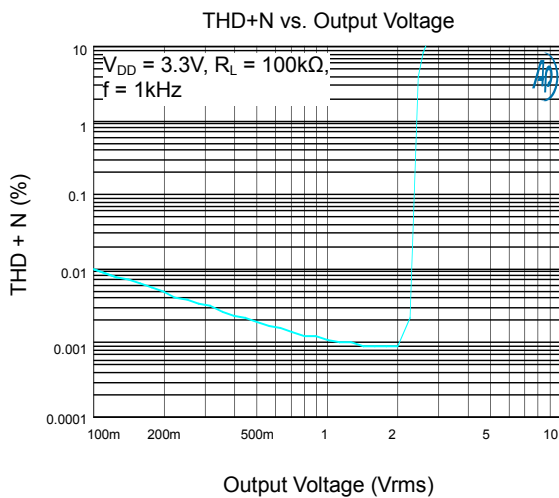
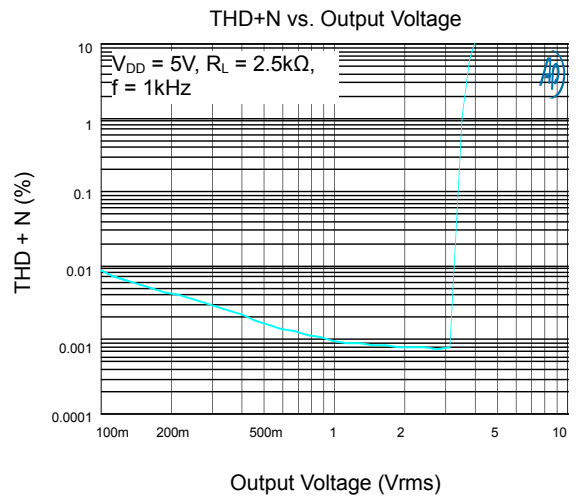
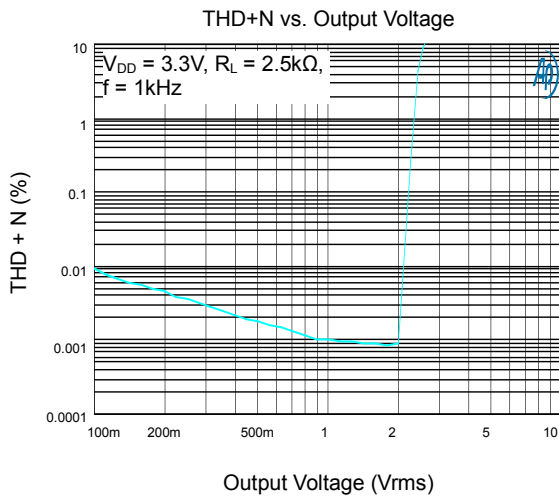
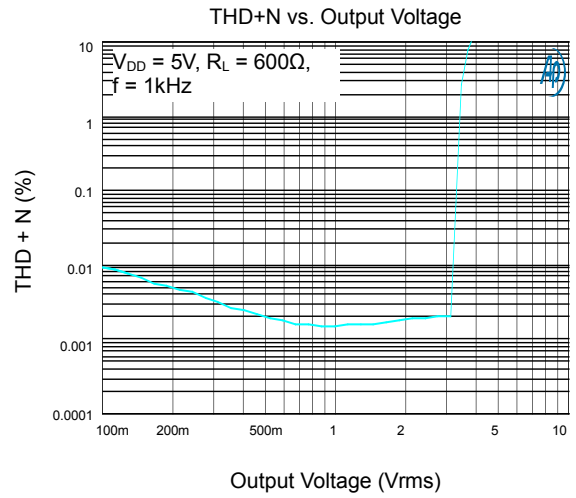
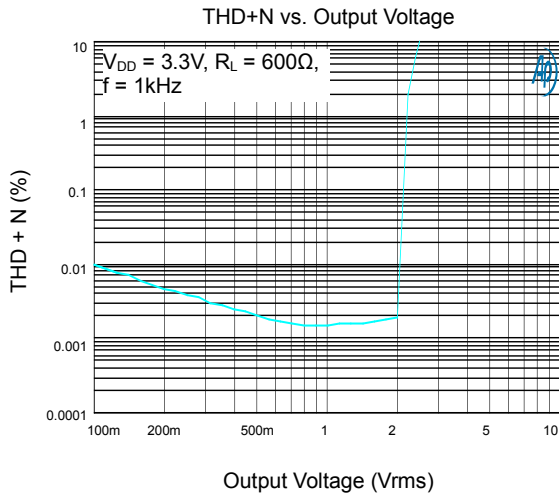

TYPICAL PERFORMANCE CHARACTERISTICS (continued)

T_A = +25°C, R_L = 2.5kΩ, C_{PUMP} = C_{PVSS} = 1μF, C_{IN} = 10μF, R_{IN} = 10kΩ, R_{FB} = 20kΩ, unless otherwise noted.

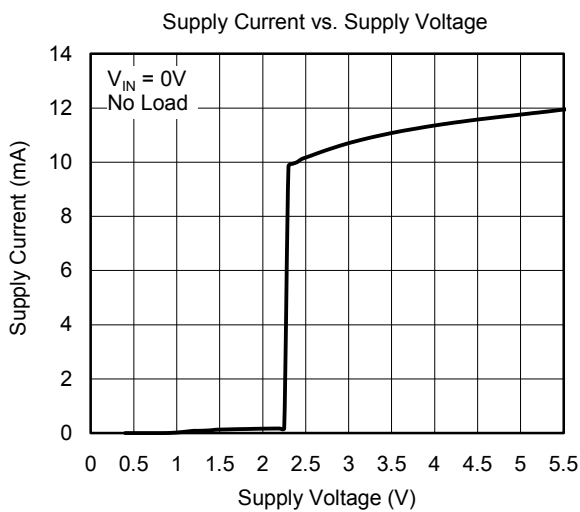
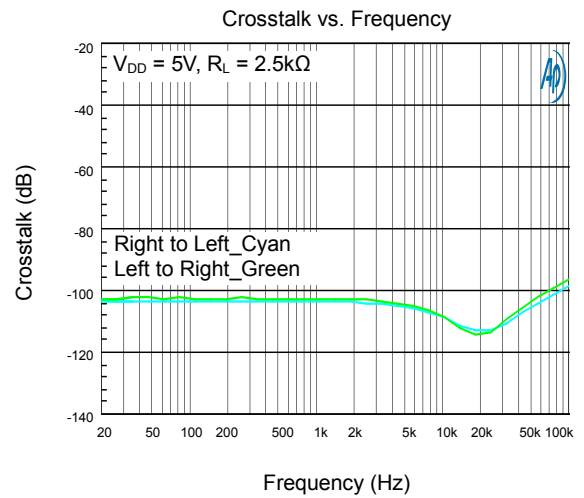
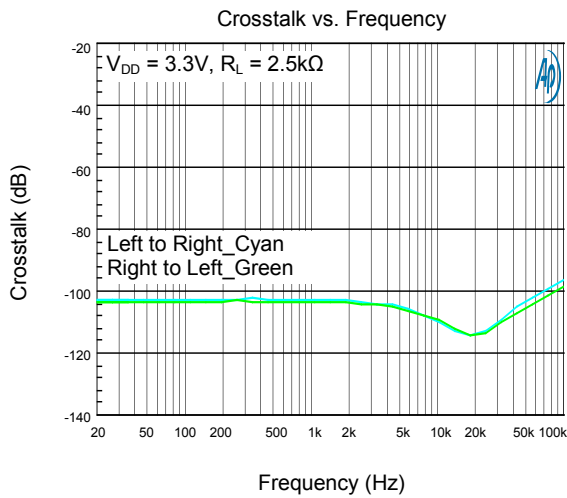
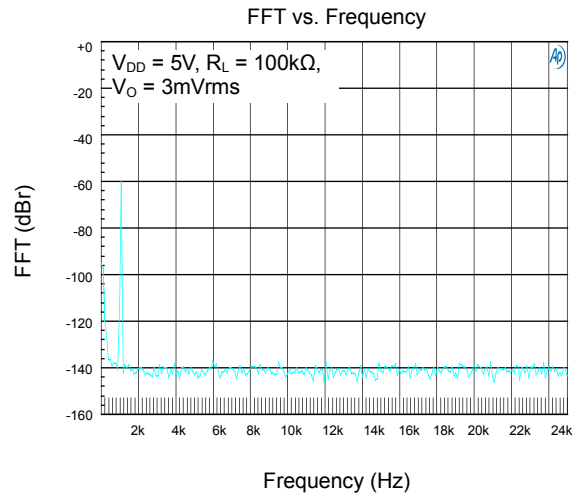
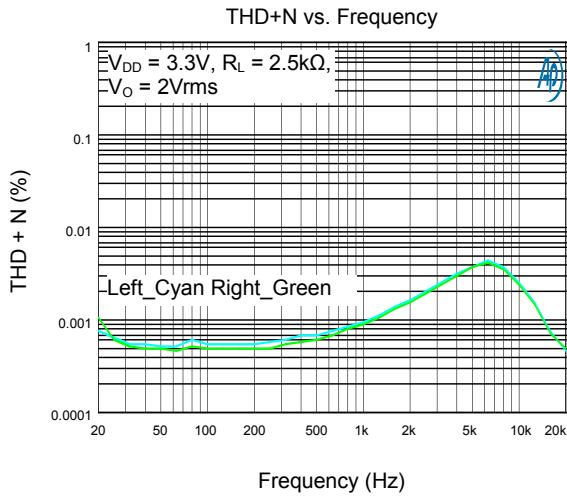

TYPICAL APPLICATION CIRCUIT

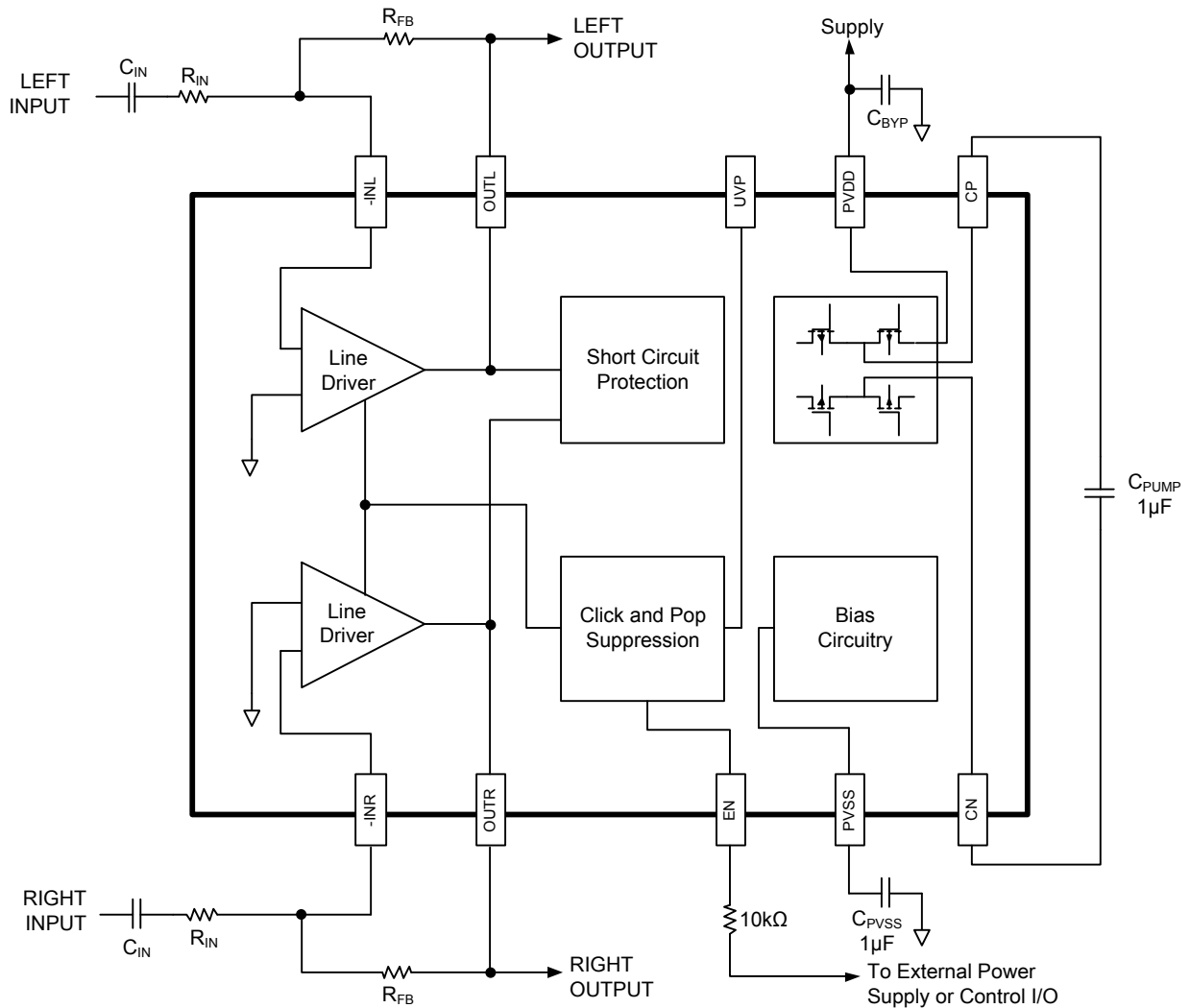

NOTES:

1. In order to get good performance, it's important to select the right C_{PUMP} , C_{PVSS} and C_{BYP} in application. All tests are performed with circuit set up with X5R and X7R capacitors. Capacitors having high dissipative loss, such as Y5V capacitor, may cause performance degradation and unexpected system behavior.
2. A 10kΩ resistor is recommended to be put between EN pin and external power supply or control I/O.

APPLICATION INFORMATION

Decoupling Capacitors

The SGM8905 is a capless line driver amplifier that requires adequate power supply decoupling to ensure that the noise and total harmonic distortion (THD) are low. A good low equivalent-series-resistance (ESR) ceramic capacitor, typically 1 μ F, placed as close as possible to the device V_{DD} lead, works best. Placing this decoupling capacitor close to the SGM8905 is important for the performance of the amplifier. For filtering lower frequency noise signals, a 10 μ F or larger capacitor placed near the audio power amplifier would also help, but it is not required in most applications because of the high PSRR of this device.

Input-Blocking Capacitors

DC input-blocking capacitors are required to be added in series with the audio signal into the input pins of the SGM8905. These capacitors block the DC portion of the audio source and allow the SGM8905 inputs to be properly biased to provide maximum performance. The input-blocking capacitors also limit the DC-gain to one, limiting the DC-offset voltage at the output.

These capacitors form a high-pass filter with the input resistor, R_{IN}. The cutoff frequency is calculated using equation 1. For this calculation, the capacitance used is the input-blocking capacitor and the resistance is the input resistor, then the frequency and/or capacitance can be determined when one of the two values are given.

$$f_{c_{IN}} = \frac{1}{2\pi R_{IN} C_{IN}} \quad \text{or} \quad C_{IN} = \frac{1}{2\pi f_{c_{IN}} R_{IN}} \quad (1)$$

Pop-Free Power-Up

Pop-free power-up is ensured by keeping the \overline{SD} (EN) (shutdown pin) low during power supply ramp up and down. The EN pin should be kept low until the input AC coupling capacitors are fully charged before asserting the EN pin high. This way proper precharge of the AC coupling is performed, and pop-free power-up is achieved. Figure 1 illustrates the preferred sequence.

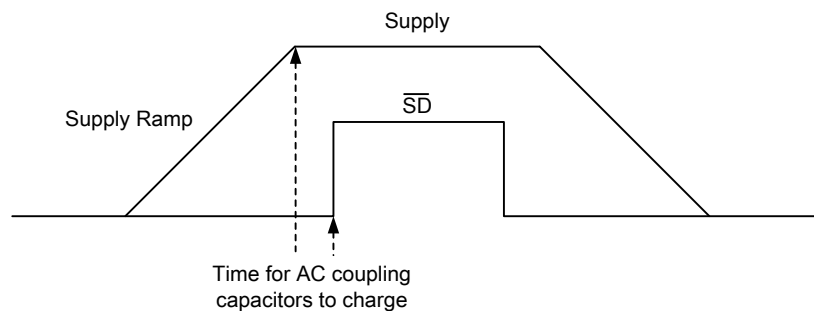

Figure 1. Power-Up Sequence

APPLICATION INFORMATION (continued)**External Under-Voltage Detection**

External under-voltage detection can be used to mute/shut down the SGM8905 before an input device can generate a pop.

The threshold seen at the UVP pin is 1.13V. A hysteresis is introduced with a resistive divider, where thresholds for startup and shutdown are determined respectively as follows:

$$\text{Startup Threshold: } V_{\text{UDPR}} = 1.13\text{V} \times (R11 + R12) / R12$$

$$\text{Shutdown Threshold: } V_{\text{UDPF}} = 1.13\text{V} \times (R11 + R12) / R12 - 4.8\mu\text{A} \times (R13 + R11 \parallel R12) \times (R11 + R12) / R12$$

$$\text{Hysteresis: } 4.8\mu\text{A} \times (R13 + R11 \parallel R12) \times (R11 + R12) / R12$$

The R13 is optional. If the R13 is not used, the UVP pin connects to the divider center tap directly.

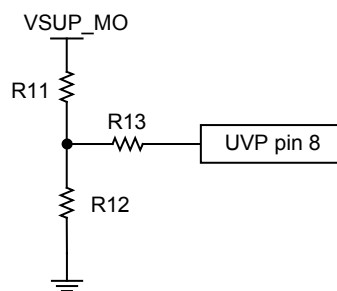
**Capacitive Load**

The SGM8905 has the ability to drive large capacitive load up to 220pF directly, and larger capacitive loads can be accepted by adding a series resistor of 47Ω or larger.

Gain-Setting Resistors

The gain-setting resistors, R_{IN} and R_{FB} , must be placed close to the input pins to minimize the capacitive loading on these pins and to ensure maximum stability of the SGM8905.

APPLICATION INFORMATION (continued)

PCB Layout Guide

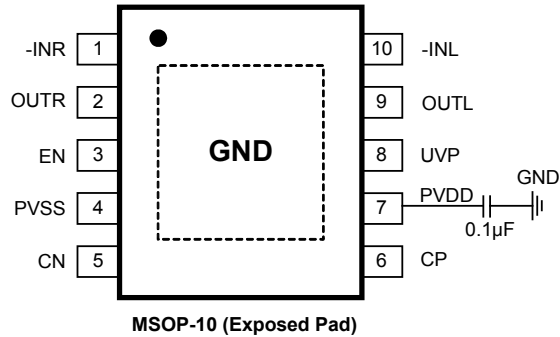

NOTE: 0.1µF decoupling capacitor must be close to GND and PVDD pins; capacitor can be connected between PVDD and GND pins directly and then connect GND pin to GND layer.

The reference PCB layout is shown in below:

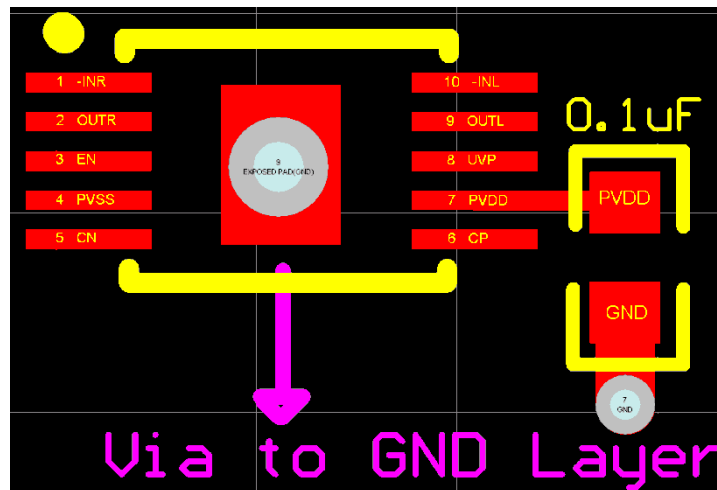

Zoomed in:

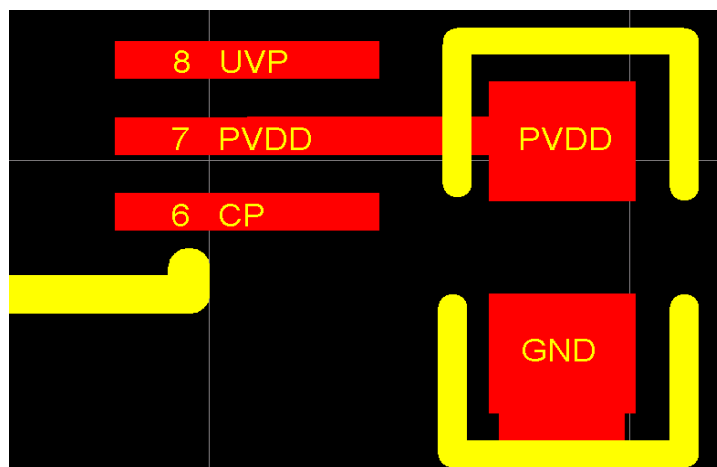

PACKAGE OUTLINE DIMENSIONS

MSOP-10 (Exposed Pad)

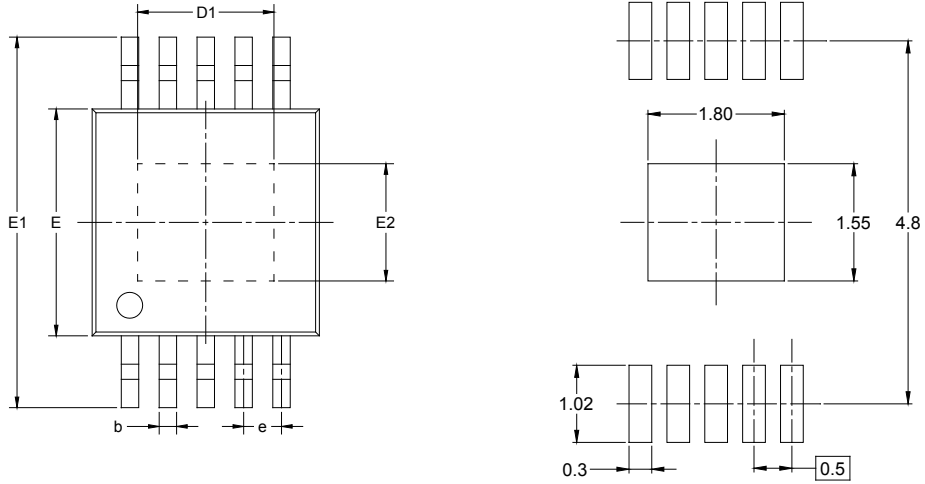

RECOMMENDED LAND PATTERN (Unit: mm)

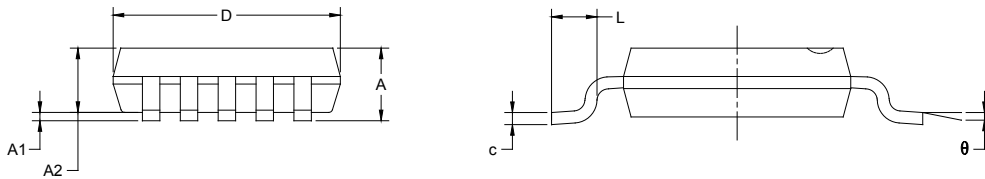

Symbol	Dimensions In Millimeters		Dimensions In Inches	
	MIN	MAX	MIN	MAX
A	0.820	1.100	0.032	0.043
A1	0.020	0.150	0.001	0.006
A2	0.750	0.950	0.030	0.037
b	0.180	0.280	0.007	0.011
c	0.090	0.230	0.004	0.009
D	2.900	3.100	0.114	0.122
D1	1.700	1.900	0.067	0.075
E	2.900	3.100	0.114	0.122
E1	4.750	5.050	0.187	0.199
E2	1.450	1.650	0.057	0.065
e	0.500 BSC		0.020 BSC	
L	0.400	0.800	0.016	0.031
θ	0°	6°	0°	6°

TAPE AND REEL INFORMATION

REEL DIMENSIONS



TAPE DIMENSIONS



NOTE: The picture is only for reference. Please make the object as the standard.

KEY PARAMETER LIST OF TAPE AND REEL

Package Type	Reel Diameter	Reel Width W1 (mm)	A0 (mm)	B0 (mm)	K0 (mm)	P0 (mm)	P1 (mm)	P2 (mm)	W (mm)	Pin1 Quadrant
MSOP-10 (Exposed Pad)	13"	12.4	5.20	3.30	1.20	4.0	8.0	2.0	12.0	Q1

000001

PACKAGE INFORMATION

CARTON BOX DIMENSIONS



NOTE: The picture is only for reference. Please make the object as the standard.

KEY PARAMETER LIST OF CARTON BOX

Reel Type	Length (mm)	Width (mm)	Height (mm)	Pizza/Carton
13"	386	280	370	5

DD0002